

# CMT ORANGE TOOLS®

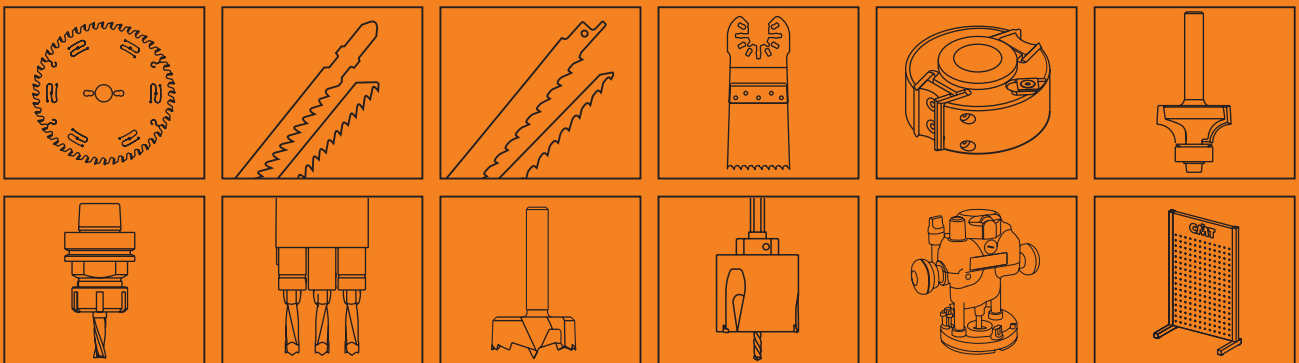

## THE WIDEST TOOLING RANGE



CATALOGUE ENGLISH EDITION 2020

# Welcome to the 2020 catalogue

*Dear Customer,*

*Thank you for your interest in CMT products.*

*Take a moment to browse our new catalogue and choose from an even wider range of innovative and state-of-the-art woodworking tools, from router bits, saw blades, jig and sabre saw blades, hole saws, and boring bits to oscillating tools, CNC cutters, cutter heads, chucks, power tools, and so much more!*

*A detailed list of spare parts on each product category is also provided to guide you through your purchase.*

*We continually strive to develop our technical know-how and make significant investments in research and development, but our greatest priority is customer care. A satisfied customer is worth more than any other achievement; therefore, each page of this catalogue contains CMT's highest commitment to the professional woodworker.*

*Should you not find a product that suits your needs, please let us know. Our highly skilled engineers and design technicians are always keen to assist you with your woodworking operations.*

*Thank you for your interest in CMT Orange Tools.*

*Your CMT Team*



## OUR CHANNELS



[www.cmtorangetools.com](http://www.cmtorangetools.com)



[www.youtube.com/user/cmtorangetools](http://www.youtube.com/user/cmtorangetools)



[www.facebook.com/cmt.italy](http://www.facebook.com/cmt.italy)



[www.instagram.com/cmt\\_orangetools](http://www.instagram.com/cmt_orangetools)







## Abbreviations

<b>A</b>	= Cutting angle	<b>L</b>	= Overall length
$\alpha$	= Hook angle	<b>L<sub>1</sub></b>	= Working length
<b>ATB</b>	= Alternate top bevel grind	<b>LB</b>	= Adjusting length
<b>B</b>	= Bore diameter	<b>LH</b>	= Left-hand rotation
$\beta$	= Type of grind	<b>MATB</b>	= Alternate top bevel with chamfer grind
<b>COMBI3</b>	= Pin-Hole 2/7/42 + 2/9/46,4 + 2/10/60	<b>MTCG</b>	= Triple chip grind (trapezoidal) with chamfer
<b>COMBI5</b>	= Pin-Hole 2/7/110 + 2/8,4/130 + 2/14/110 + 4/9/100 + 4/19/120	<b>mm</b>	= Millimeters
<b>COMBI7</b>	= Pin-Hole 2/10/80 + 1/11/85 + 2/11/115 + 2/11/148 + 2/14/100 + 2/14/125 + 2/19/120	<b>P</b>	= Plate thickness
<b>d</b>	= Small cutting diameter	<b>PTFE</b>	= Non-stick industrial coating, black and orange
<b>D</b>	= Diameter	<b>R, R<sub>1</sub></b>	= Radius
<b>D<sub>2</sub></b>	= Overall diameter	<b>RH</b>	= Right-hand rotation
<b>D<sub>3</sub></b>	= For shank diameter	<b>RPM</b>	= Round per minute
$\emptyset$	= Diameter	<b>S, S<sub>1</sub></b>	= Shank diameter
<b>FFT</b>	= Flat flat trapezoidal	<b>T<sub>1</sub></b>	= Thickness / Maximum joint thickness
<b>FTG</b>	= Flat top grind	<b>TCG</b>	= Triple chip grind (trapezoidal)
<b>FWF</b>	= Flat with alternate chamfer	<b>TS</b>	= Tooth spacing
<b>H</b>	= Cutting depth	<b>TPI</b>	= Teeth per inch
<b>HDF</b>	= Hollow ground teeth	<b>V</b>	= Spurs
<b>I</b>	= Cutting length	<b>W</b>	= Width
<b>I<sub>1</sub></b>	= Short cutting length	<b>Z</b>	= Number of teeth
<b>K</b>	= Kerf thickness	<input type="checkbox"/>	= On request
		●	= Solid tungsten carbide
			= Dispatch Package Qty.

## THE RIGHT TOOLS FOR THE BEST RESULTS!

Quick reference charts and pictograms help you choose the right tools for your application.

	 SAW BLADES	 JIG SAW BLADES	 SABRE SAW BLADES	 MULTI-CUTTERS	 HOLE SAWS
<b>WOOD</b>					CARBIDE
<b>WOOD &amp; METAL</b>		✓	✓	✓	
<b>METAL</b>					BI-METAL
<b>ALUMINIUM</b>					
<b>MULTI-MATERIAL</b>					
<b>PLASTIC</b>					
<b>MASONRY</b>					DIAMOND
<b>SPECIAL</b>					



## SAW BLADES

4~50



## JIG SAW BLADES

51~57



## SABRE SAW BLADES

58~68



## TOOLS FOR MULTI-CUTTERS

69~94



## TOOLS WITH BORE & KNIVES

95~138

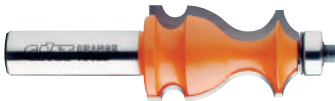

## ROUTER BITS & SET

139~245



## CNC ROUTER CUTTERS & CHUCKS

246~290



## INDUSTRIAL DOWEL DRILLS

291~316



## BITS FOR HAND POWER TOOLS

317~335



## HOLE SAWS

336~349



## POWER TOOLS, JIGS & ACCESSORIES

351~382



## DISPLAY CABINETS

383~391



## SPARE PARTS

392~396



## SINCE 1962 - MADE IN ITALY THEN, STILL MADE IN ITALY TODAY

By now, the story has been told. After over 50 years of success and quality in manufacturing woodworking tools - orange woodworking tools, to be precise - word just sort of gets around. We have grown and we have changed, but one thing still remains the same: our commitment to making only the highest quality woodworking tools.

### OUR BRANCHES



Pesaro, Italy



Greensboro, United States



Valencia, Spain

**OUR TOOLS** So, what does it take to make a CMT tool? Like all things of quality, it's not only what you do but how you do it. And anyone who works wood knows that you get out of a piece only what you put into it, and it is no different when manufacturing a tool. You choose your designs and materials carefully and you work using all of your skill and know-how. You'll be happy to know that's what we do at CMT too.

### OUR TRADEMARK COLOR ORANGE

As the story goes, we began small. We also put orange color surface coating on our tools, then we put our tools on the market and soon our orange tools were all over the world. Now, any woodworker anywhere in the world can tell you that orange tools means CMT, and that CMT means quality. Here at CMT we know we produce quality. You should too. That's why we have trademarked the color orange on woodworking tools - it's your guarantee that you are getting a genuine high-quality CMT product.

### DESIGN

Everything starts with a clear idea and having the potential to express it. We have both. At CMT, our technical department uses the best of both worlds - computer technology and hands-on experience - to engineer and design each tool so that it performs flawlessly each time you use it, and to guarantee that you'll be using it for a long, long time.

### MATERIALS

Turning a design into a finished product means finding the right material that will do the job and that lives up to the specifications set out in the design - quality performance from the final product depends on it. When it comes to selecting raw materials, we don't cut corners. At CMT, we know that high quality tools come only from high quality raw materials, so we use only solid bar stock steel and specially formulated micrograin carbide to manufacture our bits and blades.

### MANUFACTURING

Like we said, it's not just what you do but how you do it. Over the years we have continuously invested in the latest technology in CNC machining equipment and innovative software to manufacture our tools. The result is that now our entire manufacturing process, from turning and milling the steel shanks to brazing and sharpening the carbide cutting tips, is completely automated. And since a machine is only as intelligent as the person using it, everything is operated by specifically trained operators.



Loading the automated multi-axis CNC sharpening machines.



**THE FINAL TOUCH**

A tool simply wouldn't be a CMT tool if it didn't have the trademark orange color non-stick PTFE coating on it. This unique industrial-strength surface coating is designed to withstand the physical stresses the tool undergoes during use while protecting it from residue build-up and burning. And we really like the orange color too.

**QUALITY CONTROL**

Nobody's perfect, but we're trying. CMT uses rigorous quality control programs and the latest generation machining equipment to ensure that each bit has been manufactured with precision and accuracy and that it will give the long-lasting performance you expect from a CMT orange tool. Our tools are manufactured in compliance with European Standard EN 847 published and enforced by the CEN (European Committee for Standardisation).

**WE RECYCLE**

CMT filters and purifies its water using a reverse osmosis system located inside the plant. Also the oil used in grinding and machining our tools must be clean and absolutely free of contaminants. Clean oil, after enough use, gets dirty, so we filter and reprocess dirty oil on the premises.

This is our way of guaranteeing the quality of the oil we use, as well as contributing to help protect the environment.

**LOGISTICS & SERVICES**

CMT offers a wide product range with over 7000 different standard tools, but that still isn't enough to achieve 100% customer satisfaction. It's a top priority to process orders and ship the same day. That's why CMT factories worldwide are equipped with 20+ automated vertical storage systems programmed to expedite and simplify order and delivery. The tools you need, in-stock and ready for prompt shipment within 24 hours.

What does this translate to for customers? Quick and efficient service exceeding customer satisfaction and branding our success.



Greensboro, United States



Pesaro, Italy

**OUR CHANNELS**



[www.cmtorangetools.com](http://www.cmtorangetools.com)



[www.youtube.com/user/cmtorangetools](http://www.youtube.com/user/cmtorangetools)



[www.facebook.com/cmt.italy](http://www.facebook.com/cmt.italy)



[www.instagram.com/cmt\\_orangetools](http://www.instagram.com/cmt_orangetools)





**CMET**  
ORATORIO  
TOOL

# SAW BLADES



PRODUCTS	PAGE
Multi-Rip Saw Blades	9~11
Building Contractors Saw Blades	11
Universal Saw Blades	11~14
Saw Blades for Melamine & Laminated	15~19
Multi-Material Saw Blades	20~21
DP Saw Blades & Scoring	22
Scoring Saw Blades	23~24
Panel Sizing Saw Blades	25
Saw Blades for Aluminium & Non-Ferrous Materials	26~27
Saw Blades for Metal & Special Materials	28~29
ITK Plus® Saw Blades	30~32
DP Saw Blades for Ultra-Hard Materials	33
Saw Blades for Portable Machines	33~35
Contractor® Saw Blades	36
Grooving Saw Blades	37~40
Saw Blade Accessories	40
Saw Blade Index	41~48
Portable Machine Index	49~50





## HOW WE PRODUCE OUR HIGH QUALITY BLADES

CMT stands for quality, which means we put quality into everything we do. It only makes sense. At CMT we figure that if our router bits are going to be top quality, high-performance and orange, then our saw blades should be too. And to do that, we simply follow the same guidelines for our blades that we do for our bits: we start with a solid design, use only the best materials and manufacture with skill and care. And of course, make sure they are trademark orange.



### DESIGN

The simplicity of a circular saw blade design is in reality a complexity of technical considerations. Each blade has to make a certain type of cut, and this requires careful analysis of hook and grind angles, gullet designs, to location of sound dampening slots and the thickness of the blade - just to name a few. So in order for us to get the best design for our blades - and for you to get the best performance from them - we use the same method that we use to engineer our router bits: we combine the knowledgeable minds and experience of our technical department and the latest computer technology. The result is a superior blade that has some rather special “stand-ard” features:

**Anti-vibration Design.** The anti-vibration cuts in the blade do exactly what their name implies: they are the anti in anti-vibration. This translates into less chattering during cutting and consequently it lengthens the life of the blade. Anti-vibration also means a flawless cut, so stabilizers and scoring blades are no longer necessary.

**Expansion Slots.** These little hook-shaped cuts in the blade help to reduce noise while regulating the expansion and contraction of the blade as it generates heat during cutting operations.



### MATERIALS

When it comes down to it, saw blades are much like router bits - it's just two components: steel and carbide. So in selecting the raw materials, we are every bit as picky with our saw blades as we are with our router bits. Besides, why mess with a winning formula like superior steel and tungsten carbide?

**Steel.** It's the heart of the blade, so CMT uses only the finest steel available: super 42-44 Rockwell hardness steel.

**Carbide.** The cutting tips of every CMT blade are made from the best grades of micrograin carbide.

### MANUFACTURING

CMT saw blades are machined on automated CNC machines, from start to finish. The advanced technology and precision of these machines ensures uniform quality on every blade while giving us the possibility to carry out more efficient quality controls.

**Laser Cutting.** The steel plate of the blade is laser cut, NEVER die cut, from superior strength steel. This way of cutting steel is not only extremely precise but it makes it possible to cut harder strengths of steel and does not stress the plate while cutting, so the resulting blade is flat and true and more resistant to warping.

**Grinding & Tensioning.** After it has been cut, the blade is polished and tensioned, the evidence of which can be seen in the superior finish and a tension ring that are visible on the blade. Then the central bore is ground to a smooth finish so that the blade will fit precisely on the saw arbor and will have perfect concentricity during rotation. The seats for the carbide teeth are also ground, making sure that the carbide tips fit perfectly, providing the right conditions for making a secure braze.



**Silver-Copper-Silver Sandwich Brazing.** Once again, experience has been a good teacher. Automated brazing with a special silver-copper-silver “sandwich” brazing compound yields excellent results and reduces the chances of failed welds. In addition, this combination of metals is critical during brazing because as the steel body and the carbide tipped teeth are heated and cooled, they expand and contract at different rates.

The copper layer acts as a buffer and keeps the carbide from cracking during cool down shrinkage.

When woodworking, the copper provides flexibility and resistance to impact which in turn protects the carbide tips and steel shoulders when cutting through harder substances or knots in the wood.

**Specially Formulated Carbide Tips.** What is true for router bit carbide tips is also true for the carbide tips on saw blades: what’s good for one type of blade may not be good for another.

At CMT, we have studied carbide formulas and their impact on blade performance and have developed specially formulated carbide tips to match each blade’s application. Larger blades require an extra-fine harder carbide that holds its edge and resharpens easily, while smaller blades need a special carbide that can withstand the occasional nail or imperfections that often occur in construction work.

For each blade and each use, there is carbide made especially for it.

**Sharpening & Laser Marking.** The final step is sharpening the micrograin carbide teeth. During the sharpening phase, each angle is ground to razor-sharp precision - down to the Milacron - on multi-axis CNC machines.

We also laser mark our blades so you have all the details about the blade type and its uses, right there on the blade.

**Quality Control.** We always manually check the quality of our blades at each step of the manufacturing process. However, now we also use a fully automatic measuring process that measures every dimension of the blades without actually coming into contact with it.













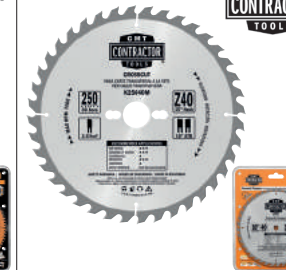



CMT’s fully automatic measuring system.

**Packaging & Instructions.** CMT blades are packed and protected for shipping, display and storage in either a sturdy cardboard box or in a patented heavy duty HDPE plastic case that’s as durable as our tools. Illustrated instructions for resharpening are included with your CMT blade so that you have all the details you need to keep the blade sharp, which will also help you extend the life of the blade.





BLADE RANGE	ORANGE CHROME®	INDUSTRIAL / XTREME	ITK PLUS®	CMT CONTRACTOR TOOLS®
PERFORMANCE	SUPERIOR ★★★★★	BEST ★★★★★	BETTER ★★★	GOOD ★★
DESCRIPTION	<p>Designed for professional woodworkers who require high precision and durability from their saw blades. Special chrome carbide reduces tooth abrasion, whereas the chrome plated body protects against rust, corrosion and guarantees long-lasting performance.</p> 	<p>Designed for fine woodworkers, finish carpenters, construction and industrial users who run their blades all day long demanding ultimate precision and extended life, while conquering the most challenging applications.</p> 	<p>Designed for the professional contractor and remodeler, CMT's ITK Plus® delivers a clean, fast, effortless cut through wood and wood composite material. The features of the ITK Plus® line offer great price-performance balance which means greater value.</p> 	<p>Designed for the contractor and remodeler CMT's Contractor® thin-kerf blade line delivers solid performance at a very economical price. Ideal for any construction projects that require cutting wood and wood composite material.</p> 
USER	Professional Woodworker	Professional	Contractor & Remodeler	Contractor & Remodeler
USAGE	Run All Day	Run All Day	Daily Use	Daily Use
PRICE POINT	Premium	Premium	Mid	Value
MATERIALS	Wood, plywood, OSB, laminate, melamine, mouldings, MDF.	Wood, Wood with nails, Plywood, OSB, Laminate, Melamine, MDF, Non-Ferrous, Metals, Stainless Steel, Plastics, Fiberglass, Solid Surface.	Wood, Composite Decking, Plywood, OSB, Laminate, Melamine, MDF, Fibercement.	Wood, Composite Decking, Plywood, OSB, Laminate, Melamine, MDF.
STEEL PLATE	LASER-CUT PREMIUM QUALITY STEEL PLATE Made of 46-48 HRC precision German steel which is laser-cut to provide tighter tolerances ensuring longer life and more accurate cuts.	LASER-CUT PREMIUM QUALITY STEEL PLATE Made of 46-48 HRC precision German steel which is laser-cut to provide tighter tolerances ensuring longer life and more accurate cuts.	HEAVY-DUTY LASER-CUT PLATE Made of a thin & strong plate, laser cut from the finest steel which is then hardened to 44 HRC ensuring longer life and precision cutting.	HEAVY-DUTY STAMPED DIE CUT PLATE Made of a thin & strong plate cut from the finest steel which is then hardened to 44 HRC ensuring longer life and precision cutting.
CARBIDE TEETH	 <p><b>INDUSTRIAL CHROMIUM MICROGRAIN CARBIDE</b> Cutting teeth are made from a specially formulated chromium micrograin carbide which stays sharper longer by reducing cutting edge abrasion, improving cut quality and tool life.</p>	 <p><b>INDUSTRIAL CHROMIUM MICROGRAIN CARBIDE</b> Special formulated chromium micrograin carbide which stays sharper longer by reducing cutting edge abrasion, improving cut quality and tool life.</p>	 <p><b>INDUSTRIAL SINTERHIP HI-DENSITY CARBIDE</b> The new process SinterHIP (high temperature 1025°C and high pressure 105 bar) creates a porosity-free and Hi-Density carbide which provides a longer cutting life than traditional carbide.</p>	 <p><b>LONG LASTING CONSTRUCTION GRADE CARBIDE</b> A specially formulated construction grade carbide which promises longer cutting life and greater resistance to impact.</p>
KERF	THICK	FULL KERF	THIN-KERF	THIN-KERF
BRAZING	 <p><b>TRI-METAL BRAZING</b> The Silver-Copper-Silver tri-metal brazing process lets the teeth withstand severe impact caused by cutting harder wood and composite material.</p>	 <p><b>TRI-METAL BRAZING</b> The Silver-Copper-Silver tri-metal brazing process lets the teeth withstand severe impact caused by cutting harder wood and composite material.</p>	<p><b>SILVER BRAZING</b> The silver brazing process lets the teeth withstand the standard impact caused by cutting soft wood and composite material.</p>	<p><b>SILVER BRAZING</b> The silver brazing process lets the teeth withstand the standard impact caused by cutting soft wood and composite material.</p>
COATING	 <p><b>CHROME® COATING</b> Blade plate is covered with a chrome layer to protect your tool against corrosion and rust, guaranteeing longer tool life.</p>	<p><b>HARD LACQUER</b> Protects against corrosion and rust.</p>	 <p><b>NON-STICK ORANGE SHIELD COATING®</b> Keeps the blade running cool, reduces pitch build up and protects against corrosion. Ideal for all types of wood including wet lumber.</p>	<p><b>HARD LACQUER</b> Protects against corrosion and rust.</p>
EXPANSION SLOTS	 <p><b>LASER-CUT HEAT EXPANSION SLOTS</b> Engineered to allow the blade to expand when heat build-up occurs from use, preventing blade warping.</p>	<p><b>LASER-CUT HEAT EXPANSION SLOTS</b> Are engineered to allow the blade to expand when heat build-up occurs from use, preventing blade warping.</p>	<p><b>LASER-CUT HEAT EXPANSION SLOTS</b> Engineered to allow blade expansion when heat build-up occurs from use, preventing blade warping.</p>	<p><b>HEAT EXPANSION SLOTS</b> Engineered to allow blade expansion when heat build-up occurs from use, preventing blade warping.</p>
SOUND DAMPENING CHANNELS	<p><b>LASER-CUT SLOTS FILLED WITH SOUND-DAMPENING MATERIAL</b> Slots are filled with polyurethane to reduce vibrations and noise (10% less than standard saw blades), improving cut quality and blade life.</p>	<p><b>LASER-CUT SOUND-DAMPENING CHANNELS</b> Specifically designed to dampen running noise and control wobbling caused by unwanted harmonic vibration.</p>	<p><b>LASER-CUT SOUND-DAMPENING CHANNELS</b> Specifically designed to dampen running noise and control wobbling caused by unwanted harmonic vibration.</p>	✗
TENSIONING RINGS	<p><b>TENSIONING RING</b> A visible tensioning ring on the blade body provides stability during cut and perfect concentricity during rotation.</p>	<p><b>TENSIONING RING</b> A visible tensioning ring on the blade body provides stability during cut and perfect concentricity during rotation.</p>	✗	✗
SHARPENING	 <p><b>PRECISION MIRROR FINISH SHARPENING</b> Each tooth is ground to razor sharp precision on a multi-axis CNC machine which creates perfect edge angle, guaranteeing extra-clean cuts and extended life. Featuring less than 0.25 µm Rmax in edge roughness.</p>	 <p><b>PRECISION MIRROR FINISH SHARPENING</b> Each tooth is ground to razor sharp precision on a multi-axis CNC machine which creates perfect edge angle, guaranteeing extra-clean cuts and extended life. Featuring less than 0.25 µm Rmax in edge roughness.</p>	 <p><b>SHEAR ANGLE SHARPENING</b> The shear angle grind on the front face of the teeth allows for smoother cutting, while reducing the required cutting force thereby improving cutting speed and setting a new standard for performance.</p>	<p><b>STANDARD SHARPENING</b> Each tooth is sharpened and carefully inspected to guarantee cleaner cuts and longer life.</p>



**279**

**APPLICATION:** for rip cutting where the rakers prevent contact between the steel plate body and the material in use.

**MACHINES:** multi-rip machines with one or two shafts.

**MATERIAL:** (wet or dry) soft and hardwood.

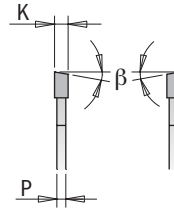
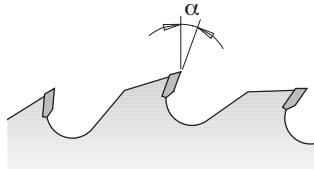
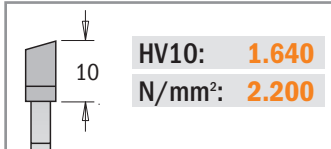
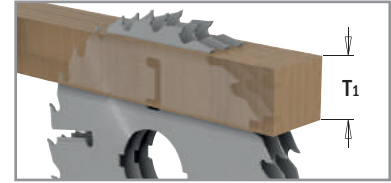

D mm	B mm	KEY WAY	PIN HOLE	Z	K mm	P mm	T <sub>1</sub> mm	α	β		ORDER NO.
250	30		COMBI3	20+4	3,2	2,2	65	18°	10° ATB	1	<b>279.020.10M</b>
250	70	21 x 5		20+4	3,2	2,2	65	18°	10° ATB	1	<b>279.020.10V</b>
250	80	13 x 5		20+4	3,2	2,2	65	18°	10° ATB	1	<b>279.020.10W</b>
300	30		COMBI3	24+4	3,2	2,2	80	18°	10° ATB	1	<b>279.024.12M</b>
300	60	21 x 5		24+4	3,2	2,2	80	18°	10° ATB	1	<b>279.024.12U</b>
300	70	21 x 5		24+4	3,2	2,2	80	18°	10° ATB	1	<b>279.024.12V</b>
300	80	13 x 5		24+4	3,2	2,2	80	18°	10° ATB	1	<b>279.024.12W</b>
350	30		COMBI3	28+4	3,5	2,5	105	18°	10° ATB	1	<b>279.028.14M</b>
350	60	21 x 5		28+4	3,5	2,5	105	18°	10° ATB	1	<b>279.028.14U</b>
350	70	21 x 5		28+4	3,5	2,5	105	18°	10° ATB	1	<b>279.028.14V</b>
350	80	14 x 5		28+4	3,5	2,5	105	18°	10° ATB	1	<b>279.028.14W</b>
400	30		COMBI3	28+6	4,0	2,8	120	18°	10° ATB	1	<b>279.028.16M</b>
400	70	21 x 5		28+6	4,0	2,8	120	18°	10° ATB	1	<b>279.028.16V</b>

Multi-Rip Anti-Kickback Saw Blades *Industrial Line*



**278**

**APPLICATION:** for rip cutting where the steel body plate prevents vibration during the cutting operation.

**MACHINES:** multi-rip machines with one or two shafts.

**MATERIAL:** dry, soft and hardwood.

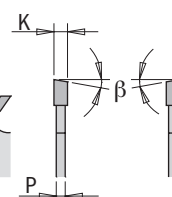
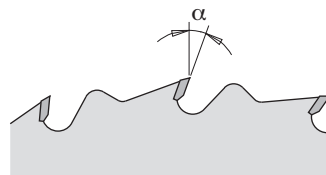
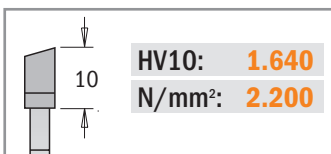

D mm	B mm	KEY WAY	PIN HOLE	Z	K mm	P mm	α	β		ORDER NO.
300	30		COMBI3	28	3,2	2,2	18°	10° ATB	1	<b>278.028.12M</b>
300	70	21 x 5		28	3,2	2,2	18°	10° ATB	1	<b>278.028.12V</b>
350	30		COMBI3	36	3,5	2,5	18°	10° ATB	1	<b>278.036.14M</b>
350	70	21 x 5		36	3,5	2,5	18°	10° ATB	1	<b>278.036.14V</b>



## 280

**APPLICATION:** for rip cuts where the thin-kerf reduces material wastes.  
**MACHINES:** multi-rip machines with one or two shafts.  
**MATERIAL:** wet or dry hardwood.

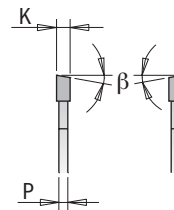
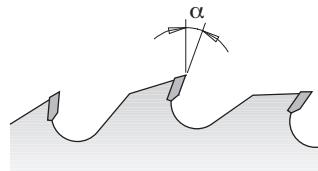
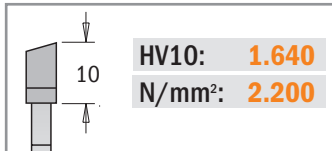
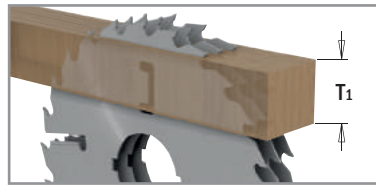

D mm	B mm	Key Way	Z	K mm	P mm	T <sub>1</sub> mm	α	β		ORDER NO.
180	40		21+3	2,5	1,8	30	18°	FLAT	1	<b>280.021.07S</b>
200	40		21+3	2,5	1,8	35	18°	FLAT	1	<b>280.021.08S</b>
250	70	21 x 5	20+4	2,7	1,8	50	18°	10° ATB	1	<b>280.020.10V</b>
250	80	13 x 5	20+4	2,7	1,8	50	18°	10° ATB	1	<b>280.020.10W</b>
300	70	21 x 5	24+4	2,7	1,8	60	18°	10° ATB	1	<b>280.024.12V</b>
300	80	13 x 5	24+4	2,7	1,8	60	18°	10° ATB	1	<b>280.024.12W</b>

# Thick-Kerf Multi-Rip Saw Blades with Rakers *Industrial Line*



## 277

**APPLICATION:** for rip cuts. Mounted on the sides of gang rip saws, these act as shoulder saw blades and ensure stability, reducing vibration under extreme work load.  
**MACHINES:** multi-rip machines with one or two shafts.  
**MATERIAL:** thick wet or dry hardwood.

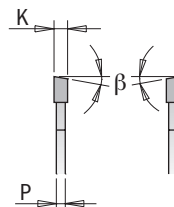
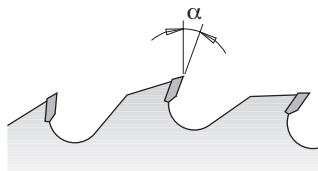
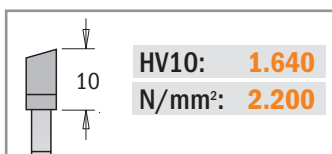
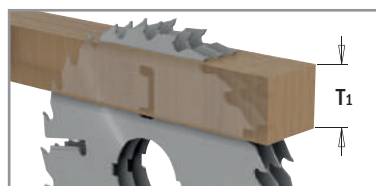

D mm	B mm	Key Way	PIN HOLE	Z	K mm	P mm	T <sub>1</sub> mm	α	β		ORDER NO.
300	30		COMBI3	24+4	4,0	2,8	80	18°	10° ATB	1	<b>277.024.12M</b>
300	70	21 x 5		24+4	4,0	2,8	80	18°	10° ATB	1	<b>277.024.12V</b>
300	80	13 x 5		24+4	4,0	2,8	80	18°	10° ATB	1	<b>277.024.12W</b>
350	30		COMBI3	24+6	4,2	2,8	105	18°	10° ATB	1	<b>277.024.14M</b>
350	70	21 x 5		24+6	4,2	2,8	105	18°	10° ATB	1	<b>277.024.14V</b>





## 286

**APPLICATION:** for rip and crosscuts especially designed for building contractors.

**MACHINES:** table saws and portable machines.

**MATERIAL:** soft and hardwood, panels with nails, metal clips and pieces of concrete.

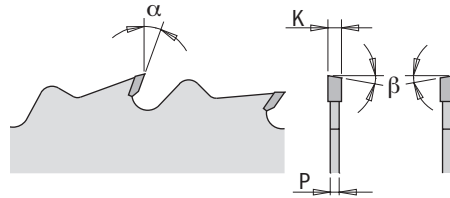
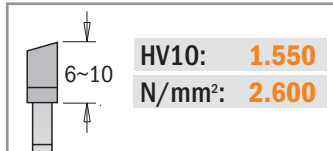

D mm	B mm	PIN HOLE	Z	K mm	P mm	$\alpha$	$\beta$		ORDER NO.
250	30	COMBI3	16	2,8	1,8	15°	5° ATB	1	286.016.10M
300	30	COMBI3	20	2,8	1,8	15°	5° ATB	1	286.020.12M
300*	30	COMBI3	48	3,2	2,2	15°	10° ATB	1	286.048.12M
315	30	COMBI3	24	3,2	2,2	15°	5° ATB	1	286.024.13M
350	30	COMBI3	24	3,2	2,2	15°	5° ATB	1	286.024.14M
400	30	COMBI3	28	3,2	2,2	15°	5° ATB	1	286.028.16M
450	30	2/10/60	32	3,8	2,8	15°	5° ATB	1	286.032.18M
500	30	2/10/60	36	3,8	2,8	15°	5° ATB	1	286.036.20M
550	30	2/10/60	40	4,2	3,2	15°	5° ATB	1	286.040.22M
600	30	2/10/60	40	4,2	3,2	15°	5° ATB	1	286.040.24M
700	30	2/10/60	46	4,4	3,2	15°	5° ATB	1	286.046.28M

**SHOP TIPS:** Use our reduction ring from 30 to 25mm order n. 299.225.00 (for rip saw blades Ø250-300-315)  
Use our reduction ring from 30 to 25mm order n. 299.228.00 (for rip saw blades Ø350 and larger)

\*without limiter

## Rip Saw Blades Industrial Line



## 285-290-293

**APPLICATION:** for rip and glue line rip cuts.

**MACHINES:** table and special saws, portable and ripping machines for automatic or manual feeding.

**MATERIAL:** soft and hardwood.

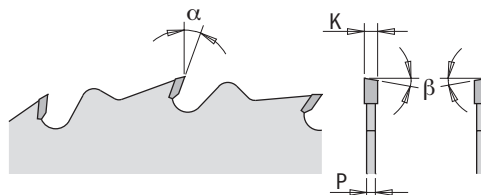
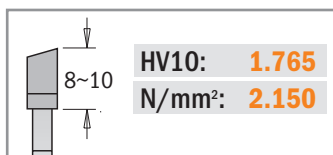

D mm	B mm	PIN HOLE	Z	K mm	P mm	$\alpha$	$\beta$		ORDER NO.
250	30	COMBI3	24	2,8	1,8	20°	10° ATB	1	290.250.24M
260	30	COMBI3	28	2,8	1,8	20°	10° ATB	1	290.260.28M
270	30	2/7/42	28	2,8	1,8	20°	10° ATB	1	290.270.28M
300	30	COMBI3	24	3,2	2,2	20°	10° ATB	1	293.024.12M
300	35		24	3,2	2,2	20°	10° ATB	1	293.024.12R
305	30	2/10/60	28	2,8	1,8	20°	10° ATB	1	293.028.22M
315	30	COMBI3	28	3,2	2,2	20°	10° ATB	1	293.028.12M
315	30	COMBI3	36	3,2	2,2	15°	5° ATB	1	285.036.13M
350	30	COMBI3	28	3,5	2,5	20°	10° ATB	1	293.028.14M
350	35		28	3,5	2,5	20°	10° ATB	1	293.028.14R
400	30	COMBI3	36	3,5	2,5	20°	10° ATB	1	285.036.16M
450	30	2/10/60	36	3,8	2,8	20°	10° ATB	1	285.036.18M
500	30	COMBI3	44	4,0	2,8	20°	10° ATB	1	285.044.20M



## 285-291-294-295

**APPLICATION:** for optimal quality rip and crosscuts.

**MACHINES:** table and special saws, portable machines.

**MATERIAL:** soft and hardwood, wood-based panels.

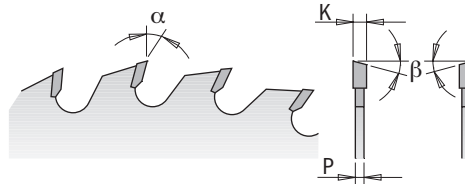
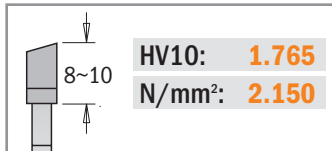

D mm	B mm	PIN HOLE 	Z	K mm	P mm	α	β		ORDER NO.
160	20	2/6/32	28	2,2	1,6	15°	10° ATB	1	<b>285.160.28H</b>
200	30	2/10/60 + 2/7/42	36	3,2	2,2	15°	10° ATB	1	<b>285.036.08M</b>
200	30	2/10/60 + 2/7/42	48	3,2	2,2	15°	15° ATB	1	<b>285.048.08M</b>
250*	20	COMBI3	40	3,2	2,2	15°	10° ATB	1	<b>285.040.10H</b>
250	30	COMBI3	40	3,2	2,2	15°	10° ATB	1	<b>285.040.10M</b>
250	30	COMBI3	48	3,2	2,2	15°	10° ATB	1	<b>285.048.10M</b>
250	30	COMBI3	60	3,2	2,2	10°	15° ATB	1	<b>285.060.10M</b>
250	35		40	3,2	2,2	15°	10° ATB	1	<b>285.040.10R</b>
250	35		60	3,2	2,2	10°	15° ATB	1	<b>285.060.10R</b>
254	30	COMBI3	48	2,4	1,8	- 5° Neg.	15° ATB	1	<b>294.048.10M</b>
254	30	COMBI3	60	2,4	1,8	- 5° Neg.	15° ATB	1	<b>294.060.10M</b>
260	30	2/10/60 + 2/7/42	48	2,8	1,8	15°	10° ATB	1	<b>285.048.11M</b>
260	30	2/10/60 + 2/7/42	60	2,8	1,8	10°	15° ATB	5	<b>285.060.11M</b>
260	30	COMBI3	60	2,5	1,8	- 5° Neg.	15° ATB	1	<b>294.060.11M</b>
270*	30	2/7/42	42	2,8	1,8	15°	15° ATB	1	<b>291.270.42M</b>
275	20		42	3,2	2,2	15°	10° ATB	1	<b>285.042.11H</b>
280*	30	2/10/60 + 2/7/42	64	2,8	1,8	10°	15° ATB	1	<b>295.064.11M</b>
300*	20	COMBI3	48	3,2	2,2	15°	10° ATB	1	<b>285.048.12H</b>
300	30	COMBI3	36	3,2	2,2	15°	10° ATB	1	<b>285.036.12M</b>
300	30	COMBI3	48	3,2	2,2	15°	10° ATB	1	<b>285.048.12M</b>
300	30	COMBI3	60	3,2	2,2	15°	10° ATB	1	<b>285.060.12M</b>
300	30	COMBI3	72	3,2	2,2	10°	15° ATB	1	<b>285.072.12M</b>
300	35		48	3,2	2,2	15°	10° ATB	1	<b>285.048.12R</b>
300	35		72	3,2	2,2	10°	15° ATB	1	<b>285.072.12R</b>
305*	30	2/10/60 + 2/7/42	54	2,8	1,8	-5° Neg.	15° ATB	1	<b>294.054.22M</b>
315*	30	COMBI3	54	3,2	2,2	15°	10° ATB	1	<b>294.054.12M</b>
350	30	COMBI3	54	3,5	2,5	15°	10° ATB	1	<b>285.054.14M</b>
350	30	COMBI3	72	3,5	2,5	15°	10° ATB	1	<b>285.072.14M</b>
350	30	COMBI3	84	3,5	2,5	10°	15° ATB	1	<b>285.084.14M</b>
350	35		54	3,5	2,5	15°	10° ATB	1	<b>285.054.14R</b>
350	35		84	3,5	2,5	10°	15° ATB	1	<b>285.084.14R</b>
400	30	COMBI3	48	3,5	2,5	20°	10° ATB	1	<b>285.048.16M</b>
400	30	COMBI3	60	3,5	2,5	10°	15° ATB	1	<b>285.060.16M</b>
450	30	2/10/60	54	3,8	2,8	15°	15° ATB	1	<b>285.054.18M</b>
450	30	2/10/60	66	3,8	2,8	10°	15° ATB	1	<b>285.066.18M</b>
500	30	2/10/60	60	3,8	2,8	15°	15° ATB	1	<b>285.060.20M</b>
500	30	2/10/60	72	3,8	2,8	10°	15° ATB	1	<b>285.072.20M</b>
550	30	2/10/60	60	4,2	3,2	10°	15° ATB	1	<b>285.060.22M</b>
550	30	2/10/60	96	4,2	3,2	10°	15° ATB	1	<b>285.096.22M</b>
600	30	2/10/60	66	4,2	3,2	10°	15° ATB	1	<b>285.066.24M</b>
700	30	2/10/60	72	4,4	3,2	10°	15° ATB	1	<b>285.072.28M</b>

\*Non-low noise



## 285-294

**APPLICATION:** for optimal quality crosscuts.  
**MACHINES:** table and sizing saws, portable machines.  
**MATERIAL:** soft, hard and exotic wood, wood-based panels.

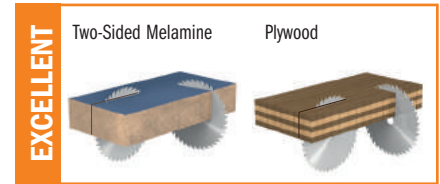
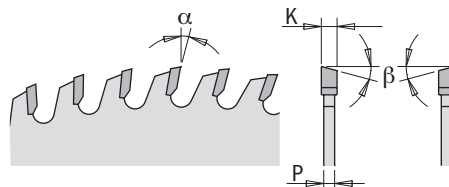
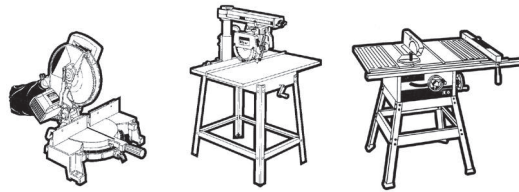
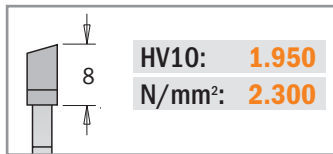

D mm	B mm	PIN HOLE	Z	K mm	P mm	α	β		ORDER NO.
150	30	2/7/42	48	3,2	2,2	5°	15° ATB	5	285.048.06M
160	20	2/6/32	48	2,2	1,6	5°	15° ATB	5	285.160.48H
180	30	2/7/42	56	3,2	2,2	5°	15° ATB	5	285.056.07M
200	30	2/10/60 + 2/7/42	64	3,2	2,2	5°	15° ATB	1	285.064.08M
250	30	COMBI3	80	3,2	2,2	5°	15° ATB	1	285.080.10M
250	35		80	3,2	2,2	5°	15° ATB	1	285.080.10R
260	30	COMBI3	80	2,5	1,8	-5° Neg.	15° ATB	1	294.080.11M
300	30	COMBI3	96	3,2	2,2	5°	15° ATB	1	285.096.12M
300	35		96	3,2	2,2	5°	15° ATB	1	285.096.12R
305	30	COMBI3	72	3,2	2,2	10°	15° ATB	1	285.072.22M
305	30	COMBI3	72	3,2	2,2	-5° Neg.	15° ATB	1	294.072.22M
315	30	COMBI3	72	3,2	2,2	15°	10° ATB	1	285.072.13M
350	30	COMBI3	108	3,5	2,5	5°	15° ATB	1	285.108.14M
350	35		108	3,5	2,5	5°	15° ATB	1	285.108.14R
400	30	COMBI3	96	3,5	2,5	10°	15° ATB	1	285.096.16M
400	30	COMBI3	120	3,5	2,5	10°	15° ATB	1	285.120.16M

## Super Finishing Saw Blades for Cutting Frames *xtreme Line*

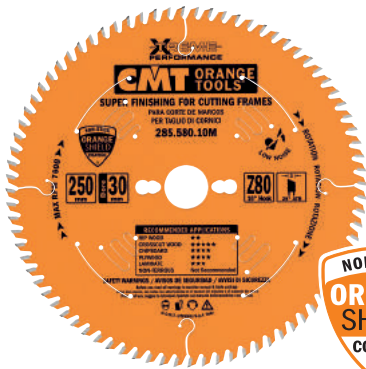

## 285.5 XTREME

**APPLICATION:** for optimal quality crosscuts on moulds and end trimming for perfect joints.  
**MACHINES:** table and sizing saws, single or double mitre saws.  
**MATERIAL:** soft and hardwood, MDF.

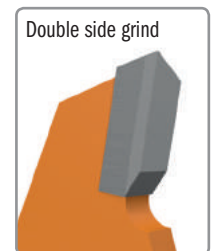
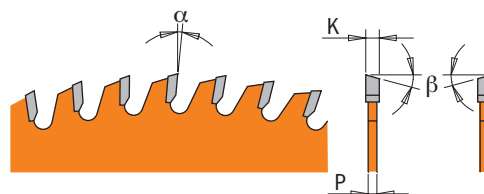
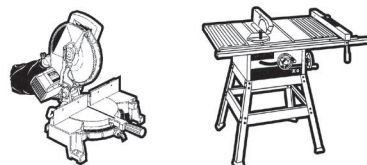
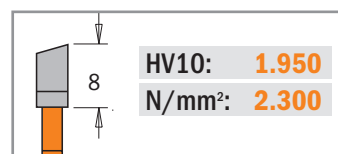

D mm	B mm	PIN HOLE	Z	K mm	P mm	α	β		ORDER NO.
250	30	COMBI3	80	3,0	2,5	10°	20° ATB	1	285.580.10M
300	30	COMBI3	96	3,0	2,5	10°	20° ATB	1	285.596.12M

Orange PTFE coated blades: a great choice for the shop that keeps its blades running all day, every day. With their heavy-gauge plate, these blades have the stamina for saws with lots of power.





## 285 ORANGE CHROME®

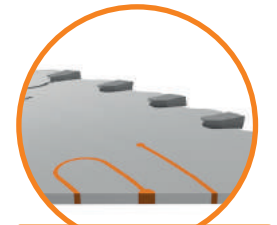
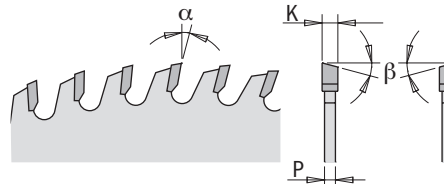
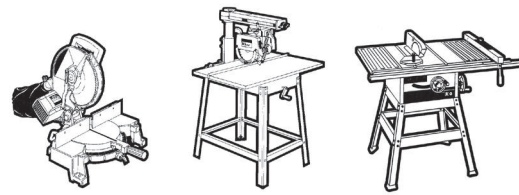

**FILLED SLOTS**

**APPLICATION:** for optimal quality rip and crosscuts.  
**MACHINES:** table and special saws, portable machines.  
**MATERIAL:** soft and hardwood, wood-based panels.

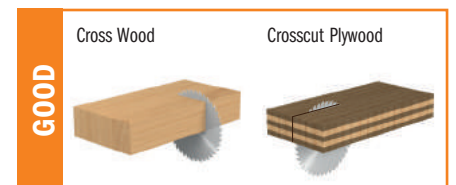
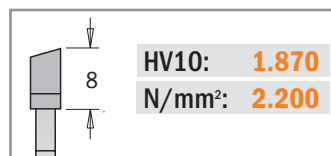

D mm	B mm	PIN HOLE	Z	K mm	P mm	α	β		ORDER NO.
250	30	COMBI3	40	3,2	2,2	15°	10° ATB	5	<b>285.640.10M</b>
300	30	COMBI3	48	3,2	2,2	15°	10° ATB	5	<b>285.648.12M</b>
350	30	COMBI3	54	3,5	2,5	15°	10° ATB	5	<b>285.654.14M</b>
400	30	COMBI3	60	3,5	2,5	10°	15° ATB	1	<b>285.660.16M</b>

**APPLICATION:** for optimal quality crosscuts.  
**MACHINES:** table and sizing saws, portable machines.  
**MATERIAL:** soft, hard and exotic wood, wood-based panels.

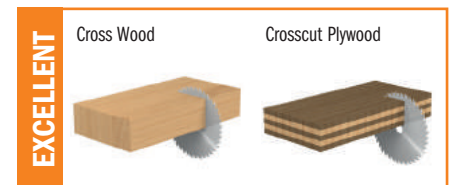
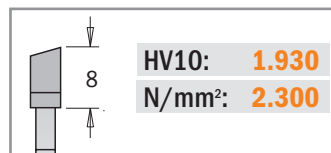

D mm	B mm	PIN HOLE	Z	K mm	P mm	α	β		ORDER NO.
250	30	COMBI3	60	3,2	2,2	10°	15° ATB	5	<b>285.660.10M</b>
300	30	COMBI3	72	3,2	2,2	10°	15° ATB	5	<b>285.672.12M</b>
350	30	COMBI3	84	3,5	2,5	10°	15° ATB	5	<b>285.684.14M</b>
400	30	COMBI3	96	3,5	2,5	10°	15° ATB	5	<b>285.696.16M</b>

**APPLICATION:** for high-quality cross cutting.  
**MACHINES:** table and sizing saws, portable machines.  
**MATERIAL:** soft, hard and exotic wood, wood-based panels, one-sided veneer, paper-base laminates and thermoplastic material.

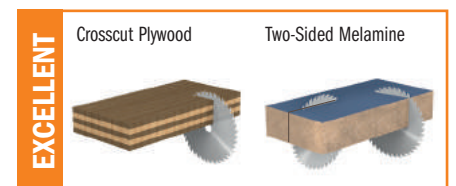
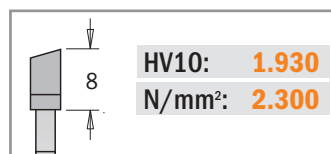

D mm	B mm	PIN HOLE	Z	K mm	P mm	α	β		ORDER NO.
250	30	COMBI3	80	3,2	2,2	5°	15° ATB	5	<b>285.680.10M</b>
300	30	COMBI3	96	3,2	2,2	5°	15° ATB	5	<b>285.696.12M</b>
350	30	COMBI3	108	3,5	2,5	5°	15° ATB	5	<b>285.708.14M</b>

# Fine Cut-Off Saw Blades for Two-Sided Melamine *Industrial Line*



## 283 ORANGE CHROME®

**APPLICATION:** for sizing cuts, perfect finishing on both sizes of double-sided panels without using scoring blades.

**MACHINES:** table and vertical saws, sizing and portable machines.

**MATERIAL:** single or double-sided laminated panels with coating and veneered panels.



**FILLED SLOTS**

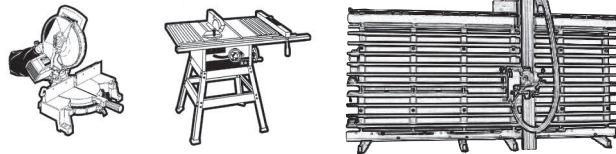

	HV10: <b>2.150</b>
	N/mm <sup>2</sup> : <b>2.500</b>

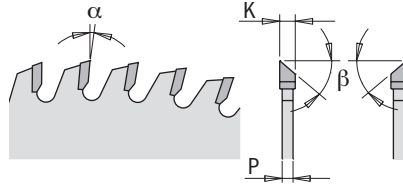
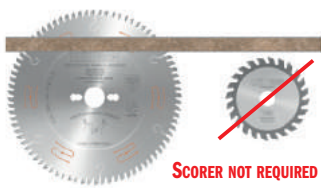

**EXCELLENT**

Cross Wood	Plywood	Two-Sided Melamine

D mm	B mm	PIN HOLE	Z	K mm	P mm	$\alpha$	$\beta$		ORDER NO.
250	30	COMBI3	80	3,2	2,2	-2° Neg.	38° ATB	5	<b>283.680.10M</b>
300	30	COMBI3	96	3,2	2,2	2°	38° ATB	5	<b>283.696.12M</b>

# Fine Cut-Off Saw Blades for Two-Sided Melamine *Industrial Line*



## 283

**APPLICATION:** for sizing cuts, perfect finishing on both sizes of double-sided panels without using scoring blades.

**MACHINES:** table and vertical saws, sizing and portable machines.

**MATERIAL:** single or double-sided laminated panels with coating and veneer.

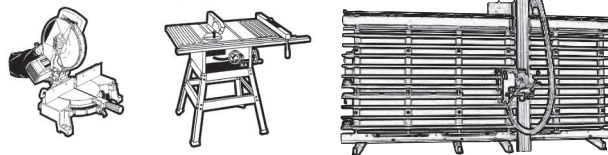

	HV10: <b>1.950</b>
	N/mm <sup>2</sup> : <b>2.300</b>

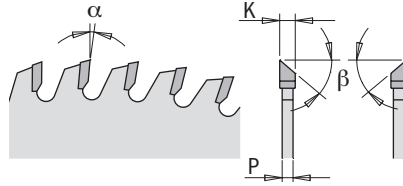
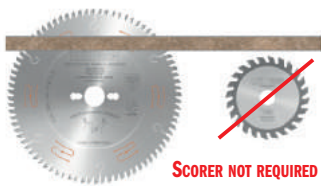

**EXCELLENT**

Cross Wood	Plywood	Two-Sided Melamine

D mm	B mm	PIN HOLE	Z	K mm	P mm	$\alpha$	$\beta$		ORDER NO.
220*	30	2/7/42	64	3,2	2,2	-5° Neg.	40° ATB	1	<b>283.064.09M</b>
250	30	COMBI3	80	3,2	2,2	-2° Neg.	40° ATB	1	<b>283.080.10M</b>
300	30	COMBI3	96	3,2	2,2	2°	40° ATB	1	<b>283.096.12M</b>
350	30	COMBI3	108	3,5	2,5	5°	40° ATB	1	<b>283.108.14M</b>

\*Non-low noise



## 274 XTREME



**APPLICATION:** for high-quality cross cutting.  
**MACHINES:** table and sizing saws, portable machines.  
**MATERIAL:** soft, hard and exotic wood, wood-based panels, one-sided veneered panels, paper-based laminate and thermoplastic material.

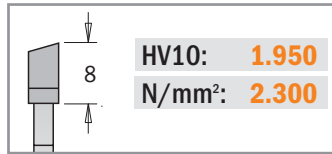

Max run out tolerance 0,05mm

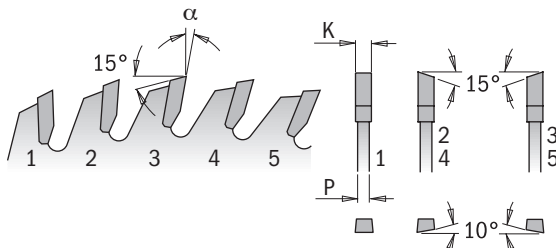
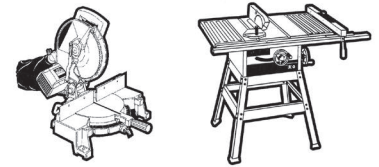

**EXCELLENT**

Two-Sided Melamine	Plywood	PVC moulding/frames	For All Non-Ferrous Metals & PVC
--------------------	---------	---------------------	----------------------------------

D mm	B mm	PIN HOLE	Z	K mm	P mm	$\alpha$	$\beta$		ORDER NO.
250	30	COMBI3	80	3,2	2,2	15°	1FTG+4ATB	1	<b>274.080.10M</b>
300	30	COMBI3	100	3,2	2,2	15°	1FTG+4ATB	1	<b>274.100.12M</b>

# Fine Cut-Off Saw Blades for Two-Sided Melamine *Industrial Line*



## 287



**APPLICATION:** for sizing cuts, perfect finishing with high feed rate and long tool life without using scoring blade.  
**MACHINES:** table and vertical saws, sizing and portable machines.  
**MATERIAL:** single or double-sided laminated panels with hard coating and veneered panels.

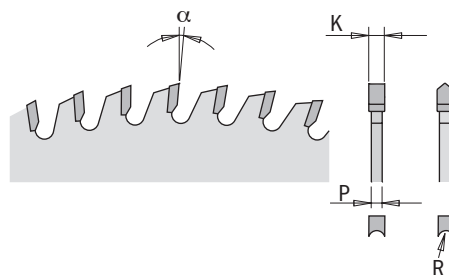
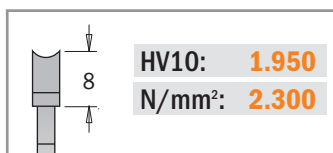
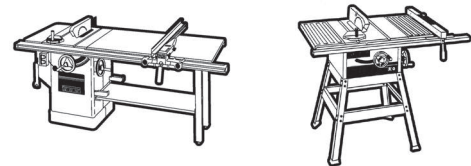
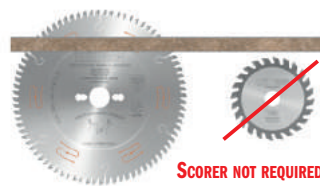

**EXCELLENT**

Crosscut Plywood	Two-Sided Melamine
------------------	--------------------

D mm	B mm	PIN HOLE	Z	K mm	P mm	$\alpha$	$\beta$		ORDER NO.
<b>Negative Hook Angle</b>									
220	30	2/7/42	42	3,2	2,2	-6° Neg.	HDF	1	<b>287.043.09M</b>
250	30	COMBI3	48	3,2	2,2	-6° Neg.	HDF	1	<b>287.049.10M</b>
303	30	COMBI3	60	3,2	2,2	-6° Neg.	HDF	1	<b>287.061.12M</b>



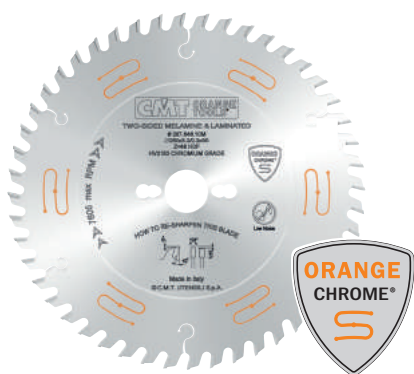

**287 ORANGE CHROME®**



**APPLICATION:** for sizing cuts, perfect finishing with high feed rate and long tool life without using scoring blade.  
**MACHINES:** table and vertical saws, sizing and portable machines.  
**MATERIAL:** single or double-sided laminated panels with hard coating and veneered panels.



**FILLED SLOTS**

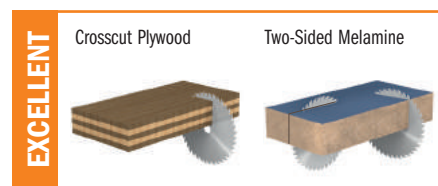
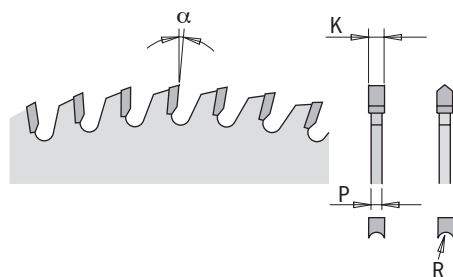
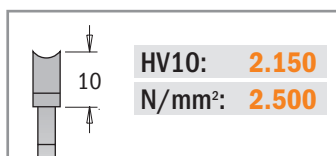
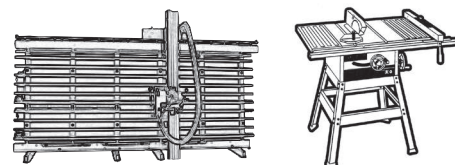
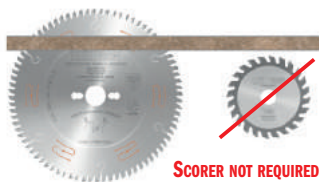

D mm	B mm	PIN HOLE	Z	K mm	P mm	α	β		ORDER NO.
<b>Positive Hook Angle</b>									
250	30	COMBI3	48	3,2	2,2	10°	HDF	5	287.648.10M
303	30	COMBI3	60	3,2	2,2	10°	HDF	5	287.660.12M



**287**



**APPLICATION:** for sizing cuts, perfect finishing with high feed rate and long tool life without using scoring blade.  
**MACHINES:** table and vertical saws, sizing and portable machines.  
**MATERIAL:** single or double-sided laminated panels with hard coating and veneered panels.

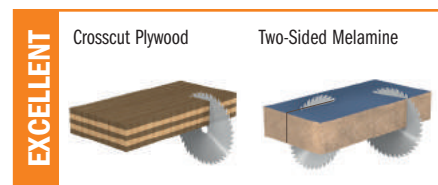
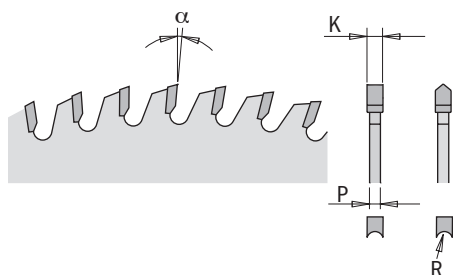
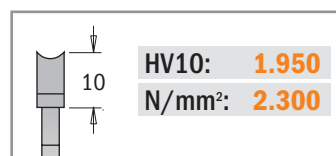
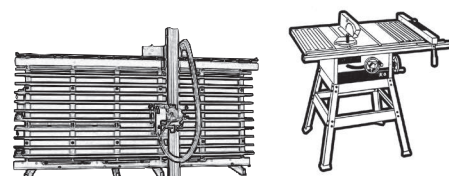
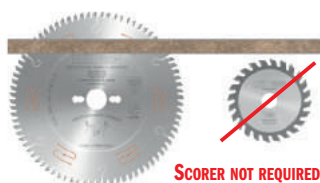

D mm	B mm	PIN HOLE	Z	K mm	P mm	α	β		ORDER NO.
<b>Positive Hook Angle</b>									
160	20	2/6/32	34	2,6	1,8	10°	HDF	5	287.034.06H
220	30	2/7/42	42	3,2	2,2	10°	HDF	1	287.042.09M
250	30	COMBI3	48	3,2	2,2	10°	HDF	1	287.048.10M
303	30	COMBI3	60	3,2	2,2	10°	HDF	1	287.060.12M

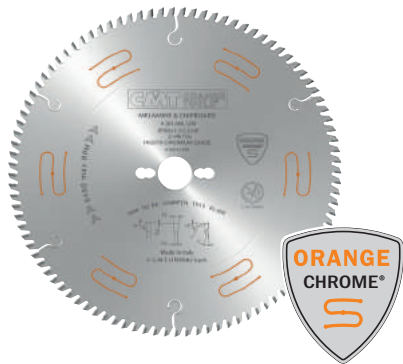

## 281 ORANGE CHROME®



**APPLICATION:** for sizing cuts, perfect finishing with scoring blades.  
**MACHINES:** table saws, horizontal and vertical sizing machines.  
**MATERIAL:** single or double-sided plastic-laminated panels.

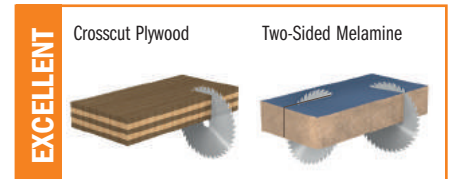
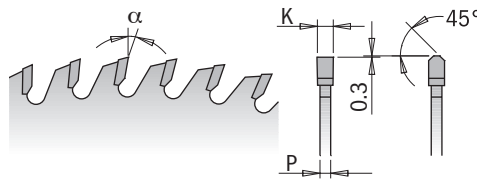
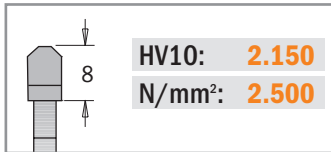
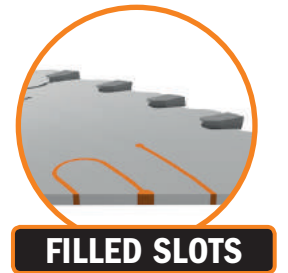
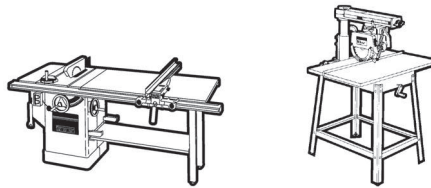

D mm	B mm	PIN HOLE	Z	K mm	P mm	α	β		ORDER NO.
250	30	COMBI3	80	3,2	2,2	5°	TCG	5	<b>281.680.10M</b>
300	30	COMBI3	72	3,2	2,2	10°	TCG	5	<b>281.672.12M</b>
300	30	COMBI3	96	3,2	2,2	5°	TCG	5	<b>281.696.12M</b>
350	30	COMBI3	84	3,5	2,5	10°	TCG	5	<b>281.684.14M</b>
350	30	COMBI3	108	3,5	2,5	5°	TCG	5	<b>281.708.14M</b>

# Melamine & Laminated Long-Lasting Saw Blades *xtreme Line*



## 295 XTREME



**APPLICATION:** for sizing cuts, perfect finishing without using scoring blade.  
**MACHINES:** table saws, horizontal and vertical sizing machines.  
**MATERIAL:** double-sided laminated panels.

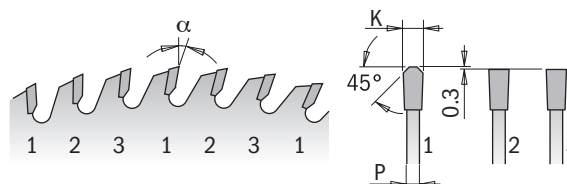
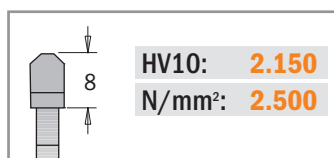
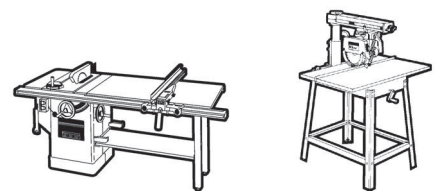
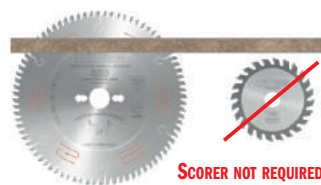

Max run out tolerance 0,05mm

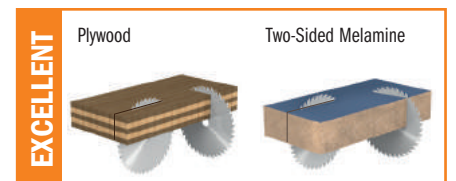

D mm	B mm	PIN HOLE	Z	K mm	P mm	α	β		ORDER NO.
250	30	COMBI3	78	3,2	2,2	10°	FFT	1	<b>295.078.10M</b>
300	30	COMBI3	96	3,2	2,2	10°	FFT	1	<b>295.096.12M</b>
350	30	COMBI3	108	3,5	2,5	10°	FFT	1	<b>295.108.14M</b>



**281**

**APPLICATION:** for sizing cuts, perfect finishing by using scoring blades.  
**MACHINES:** table saws, horizontal and vertical sizing machines.  
**MATERIAL:** single or double-sided plastic-laminated panels.

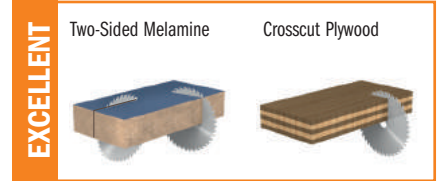
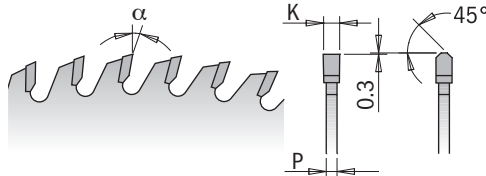
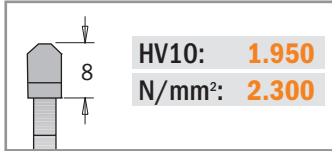
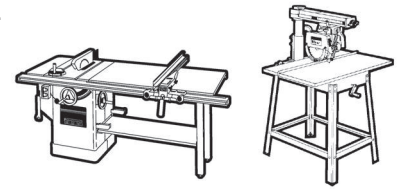

D mm	B mm	PIN HOLE	Z	K mm	P mm	$\alpha$	$\beta$		ORDER NO.
160	20 (Virutex)	4/7/32 45°	40	2,2	1,6	10°	TCG	5	281.160.40H
160*	20	2/6/32	48	2,2	1,6	10°	TCG	5	281.160.48H
190*	20 (Festool® FF)	5/7/2,5	54	2,6	1,8	4°	TCG	5	281.190.54FF
200*	30	2/7/42	64	3,2	2,2	10°	TCG	1	281.064.08M
220*	30	2/7/42	64	3,2	2,2	10°	TCG	1	281.064.09M
225*	30	2/7/42	64	2,6	1,8	4°	TCG	1	281.225.64M
250	30	COMBI3	60	3,2	2,2	10°	TCG	1	281.060.10M
250	30	COMBI3	80	3,2	2,2	10°	TCG	1	281.080.10M
300	30	COMBI3	72	3,2	2,2	10°	TCG	1	281.072.12M
300	30	COMBI3	96	3,2	2,2	10°	TCG	1	281.096.12M
350	30	COMBI3	84	3,5	2,5	10°	TCG	1	281.084.14M
350	30	COMBI3	108	3,5	2,5	10°	TCG	1	281.108.14M

\*Non-low noise

Laminated & Chipboard Saw Blades *XTreme Line*



**281 XTREME ORANGE CHROME®**

**APPLICATION:** for sizing cuts, perfect finishing without using scoring blade.  
**MACHINES:** table saws, horizontal and vertical sizing machines.  
**MATERIAL:** single or double-sided laminated panels.

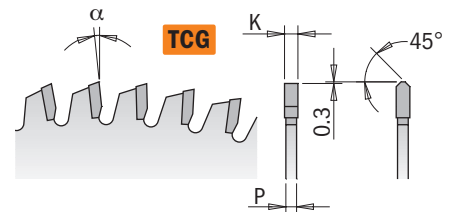
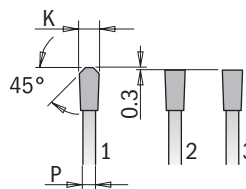
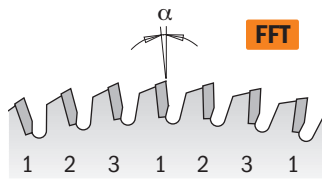
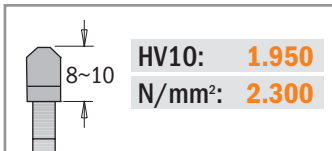
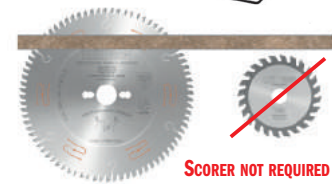
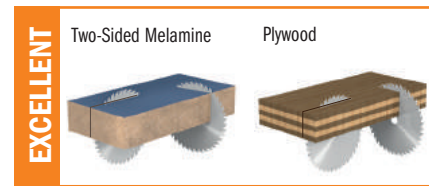
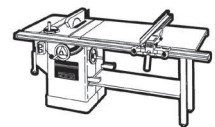

D mm	B mm	PIN HOLE	Z	K mm	P mm	$\alpha$	$\beta$		ORDER NO.
160	20	2/6/32	56	2,2	1,6	-3° Neg.	TCG	5	281.161.56H
165	20	2/6/32	56	2,2	1,6	-3° Neg.	TCG	5	281.166.56H
220	30	COMBI3	63	3,2	2,2	-3° Neg.	FFT	1	281.063.09M
250	30	COMBI3	60	3,2	2,2	-3° Neg.	FFT	1	281.061.10M
260	30	COMBI3	64	2,5	1,8	-3° Neg.	TCG	1	281.065.11M
300	30	COMBI3	72	3,2	2,2	-3° Neg.	FFT	1	281.073.12M
<b>ORANGE CHROME®</b>									
250	30	COMBI3	80	3,2	2,2	-3° Neg.	TCG	5	281.681.10M
300	30	COMBI3	96	3,2	2,2	-3° Neg.	TCG	5	281.697.12M



# XTREME ALL-AROUND THE SAW BLADES REVOLUTION!

Leuco Patent Pending tooth geometry and tool body design guarantee an extensive array of applications when working with larger traditional solid woods and wood-based panels.

The "Xtreme All-Around" blade delivers excellent quality, ensures 20 times longer lifetime and boasts a 20% reduction in noise compared to conventional carbide saw blades.

## NO LIMITS: CUT ALL THESE MATERIALS WITH ONE BLADE!

EXCELLENT

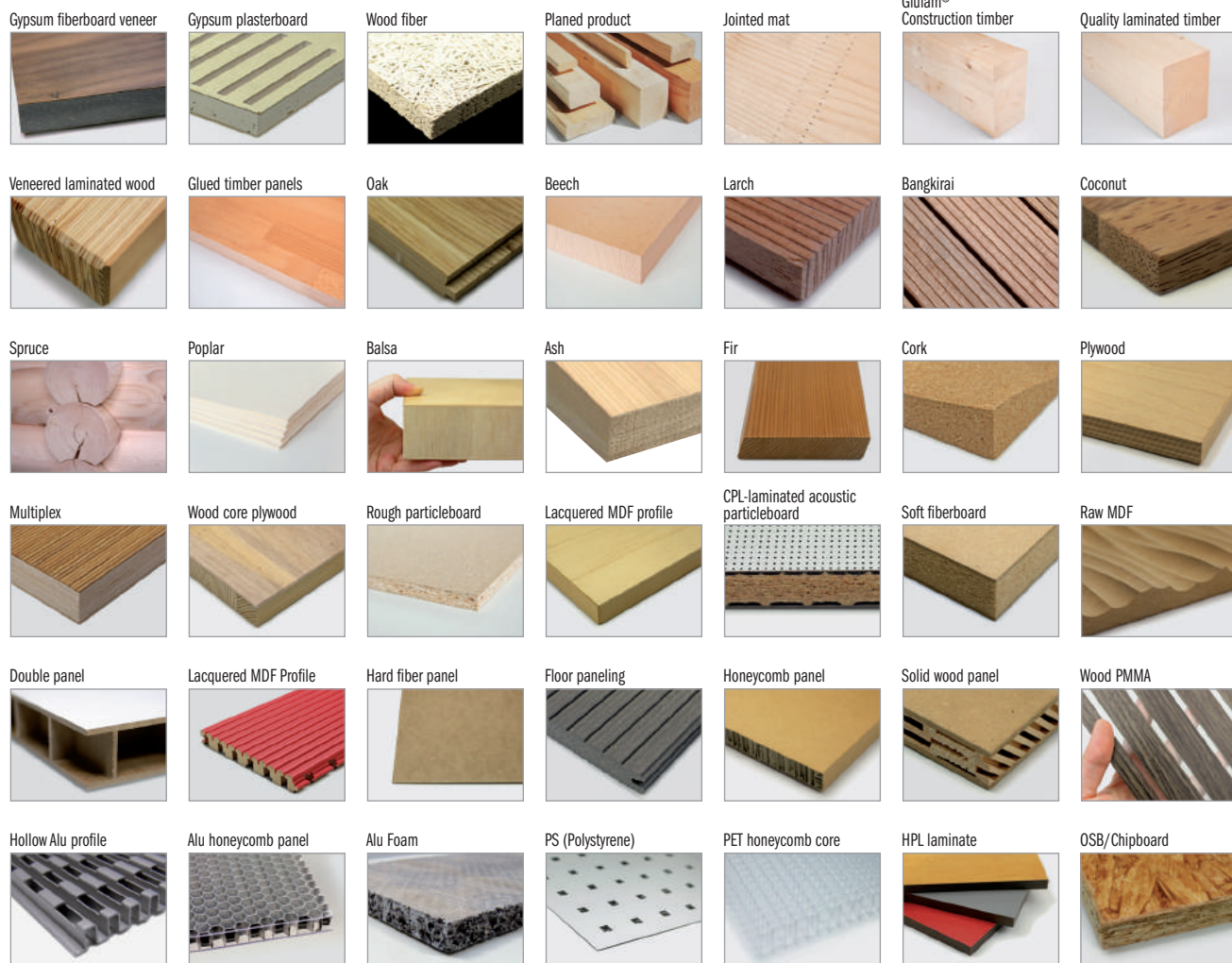

GOOD

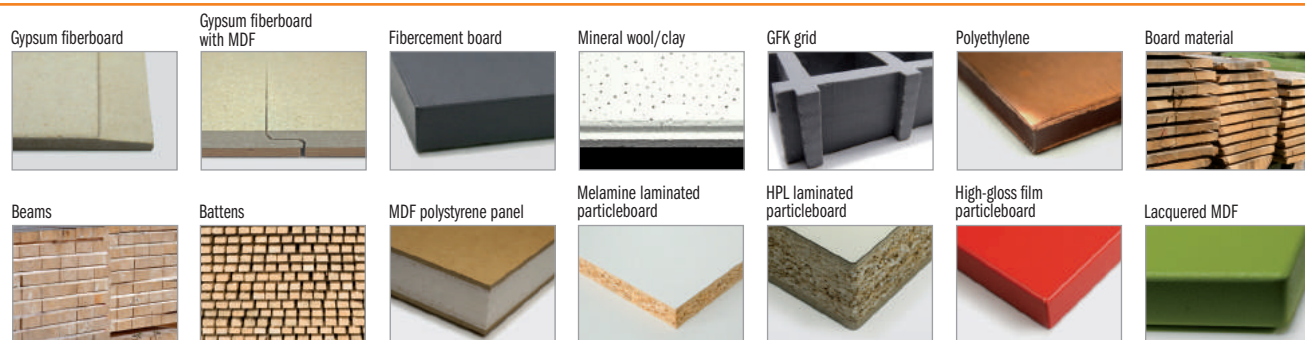

- It is not recommended to use the saw blades for longitudinal cuts in soft wood and material thicknesses of more than 40mm.
- Do not cut materials with nails, stone and metal parts.
- Chip-free cuts can only be guaranteed in combination with a suitable scoring saw blade.



## 235 XTREME-NOISELESS ALL-AROUND



**APPLICATION:** for sizing cuts, perfect finishing with high feed rate and long tool life.  
**MACHINES:** chop saws and portable machines, table and vertical panel sizing saws, CNCs and through-feed installations.  
**MATERIAL:** look at the opposite page.

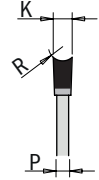
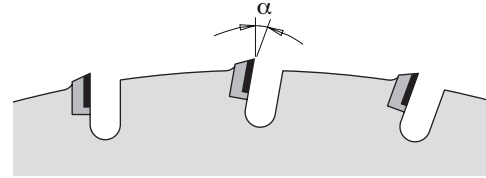

**LEUCO**  
Patent Pending



## XTREME-NOISELESS

Thanks to the new minimization of gullets design this blade succeeded in reducing the noise of idling by up to 15 dB(A) compared to conventional carbide saw blades. With a noise level of just around 70dB(A) when idling, the wearing of hearing protection is outdated.

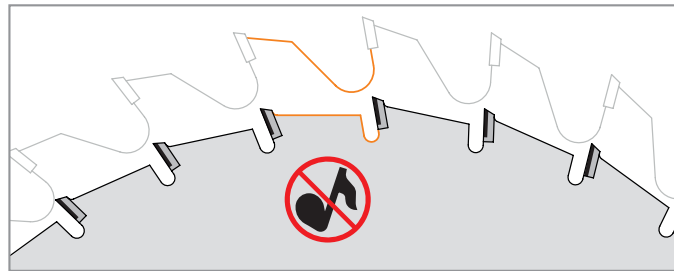

## XTREME-ALL-AROUND

New industry standard with universal application in countless materials and suitable for all chop saws and portable machines, table and vertical panel sizing saws, CNCs and through-feed installations

## XTREME-QUALITY

The special hollow back tooth configuration (HR) guarantees an excellent cutting quality.

## XTREME-FAST

The teeth are surprisingly thin! The cutting width is a mere 2,5 mm and they generate noticeably lower cutting pressure and therefore also require less power during usage. Resharpenable max 2 times.

## XTREME-LIFETIME

The lifetime is 20X longer than carbide blades thanks to the diamond tips.

### RECOMMENDED USE

We recommend the use of the splitting wedge with thickness between **2,0** and **2,4mm**.

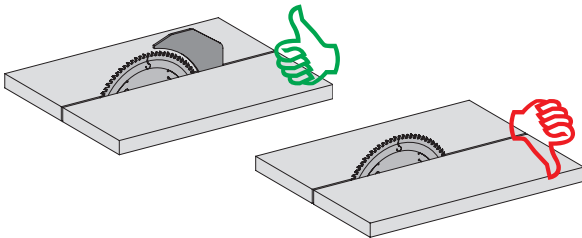

### LONGER LIFETIME THANKS TO DIAMOND TIPS

Clean your circular saw blades on a regular basis. You will profit from a long-lasting and precise cutting quality and maximize the lifetime of your innovative saw blades many times over.



D mm	B mm	PIN HOLE 	Z	K mm	P mm	$\alpha$	$\beta$		ORDER NO.
160	20	2/6/32	20	2,2	1,6	10°	HR	1	<b>235.160.20H</b>
190	30	2/7/42	24	2,5	2,0	10°	HR	1	<b>235.190.24M</b>
216	30	2/7/42	30	2,5	2,0	10°	HR	1	<b>235.216.30M</b>
250	30	COMBI3	36	2,5	2,0	10°	HR	1	<b>235.250.36M</b>
300	30	COMBI3	44	2,5	2,0	10°	HR	1	<b>235.300.44M</b>



**237 XTREME**



**APPLICATION:** for sizing cuts, perfect finishing (using scoring blade) and increased tool life up to 50 times longer than HW blades thanks to a special polycrystalline diamond formula. The best quality/price ratio!

**MACHINES:** table saws, horizontal and vertical sizing machines.

**MATERIAL:** single or double-sided plastic-laminated panels, MDF and HDF.

HV10: **10.000**  
Re-Sharpener: **6x**

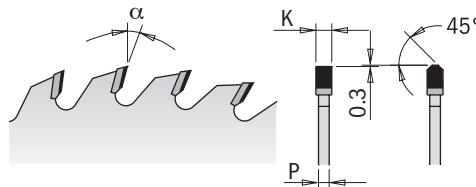

**EXCELLENT** Two-Sided Melamine Wood Products

D mm	B mm	PIN HOLE	Z	K mm	P mm	$\alpha$	$\beta$		ORDER NO.
250	30	COMBI3	48	3,2	2,2	10°	45° TCG	1	<b>237.048.10M</b>
300	30	COMBI3	60	3,2	2,2	10°	45° TCG	1	<b>237.060.12M</b>
300	30	COMBI3	96	3,2	2,2	15°	45° TCG	1	<b>237.096.12M</b>
350	30	COMBI3	72	3,5	2,4	15°	45° TCG	1	<b>237.072.14M</b>

High-quality nickel-plated saw blades with anti-friction and anti-corrosion properties.



**238 XTREME**



**APPLICATION:** for chip-free scoring of plastic-laminated panels; increased tool life up to 50 times longer than HW blades thanks to a special polycrystalline diamond formula. The best quality/price ratio!

**MACHINES:** horizontal and vertical sizing machines equipped with scoring device.

**MATERIAL:** single or double-sided plastic-laminated panels, MDF and HDF.

HV10: **10.000**  
Re-Sharpener: **6x**

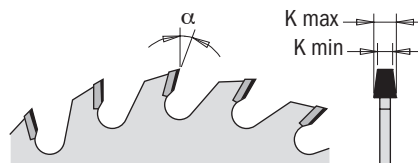

**EXCELLENT** Two-Sided Melamine Wood Products

D mm	B mm	Z	K mm	$\alpha$	$\beta$		ORDER NO.
120	20	20	3,1-3,7	5°	CONICAL	1	<b>238.120.20H</b>
125	20	20	3,1-3,7	5°	CONICAL	1	<b>238.125.20H</b>

High-quality nickel-plated saw blades with anti-friction and anti-corrosion properties.





## 289 ORANGE CHROME®



**APPLICATION:** for chip-free scoring on plastic-laminated panels.  
**MACHINES:** horizontal and vertical sizing machines equipped with scoring device.  
**MATERIAL:** single or double-sided plastic-laminated panels, MDF.

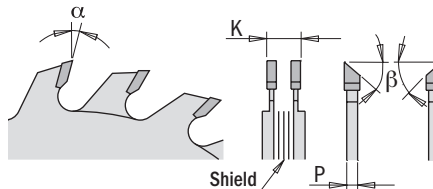
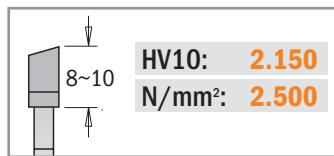

D mm	B mm	PIN HOLE	Z	K mm	$\alpha$	$\beta$		ORDER NO.
100	20	2/4,2/42	10+10	2,8-3,6	11°	5° ATB	5	<b>289.700.20H</b>
120	20	2/4,2/42	12+12	2,8-3,6	11°	5° ATB	5	<b>289.720.24H</b>
120	22	2/4,2/42	12+12	2,8-3,6	11°	5° ATB	5	<b>289.720.24K</b>
125	20	2/4,2/42	12+12	2,8-3,6	11°	5° ATB	5	<b>289.725.24H</b>

# Adjustable Scoring Blades *Industrial Line*



## 289



**APPLICATION:** for chip-free scoring on plastic-laminated panels.  
**MACHINES:** horizontal and vertical sizing machines equipped with scoring device not allowing for cutting depth adjustment.  
**MATERIAL:** single or double-sided plastic-laminated panels, MDF.

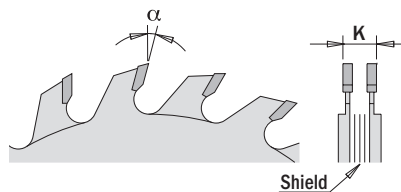
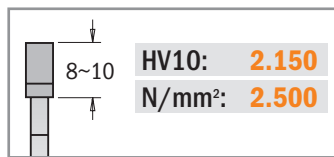

D mm	B mm	PIN HOLE	Z	K mm	$\alpha$	$\beta$		ORDER NO.	Spare parts PVC SHIMS
70	20	2/3,1 - 3,8/32	8+8	2,8-3,6	12°	FLAT	1	<b>289.070.16H</b>	299.000.05H
80	20	2/3,1 - 3,8/32	10+10	2,8-3,6	12°	FLAT	1	<b>289.080.20H</b>	299.000.05H
100	20	2/3,1 - 3,8/42	10+10	2,8-3,6	12°	FLAT	1	<b>289.100.20H</b>	299.000.02K
100	22	2/3,1 - 3,8/42	10+10	2,8-3,6	12°	FLAT	1	<b>289.100.20K</b>	299.000.02K
120	20	2/3,1 - 3,8/42	12+12	2,8-3,6	12°	FLAT	1	<b>289.120.24H</b>	299.000.02K
120	22	2/3,1 - 3,8/42	12+12	2,8-3,6	12°	FLAT	1	<b>289.120.24K</b>	299.000.02K
120	50	4/6,2 - 10/62	12+12	2,8-3,6	12°	FLAT	1	<b>289.120.24T*</b>	
125	20	2/3,1 - 3,8/42	12+12	2,8-3,6	12°	FLAT	1	<b>289.125.24H</b>	299.000.02K
125	22	2/3,1 - 3,8/42	12+12	2,8-3,6	12°	FLAT	1	<b>289.125.24K</b>	299.000.02K

\* Suitable for Altendorf Rapido System



## 288 ORANGE CHROME®

**APPLICATION:** for chip-free scoring on plastic-laminated panels.  
**MACHINES:** horizontal and vertical sizing machines equipped with scoring device.  
**MATERIAL:** single or double-sided plastic-laminated panels, MDF.

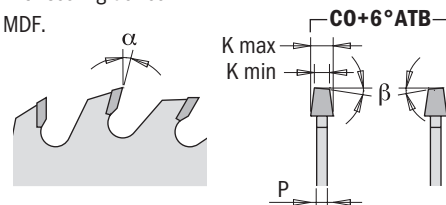
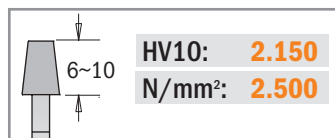

D mm	B mm	Z	K mm	P mm	α	β		ORDER NO.
120	20	24	3,1-4,3	2,2	0°	CO+6° ATB	5	288.720.24H
120	22	24	3,1-4,3	2,2	0°	CO+6° ATB	5	288.720.24K
125	20	24	3,1-4,3	2,2	0°	CO+6° ATB	5	288.725.24H

## Conical Scoring Blades Industrial Line



## 288

**APPLICATION:** for chip-free scoring on plastic-laminated panels.  
**MACHINES:** horizontal and vertical sizing machines equipped with scoring device for vertical adjustment.  
**MATERIAL:** single or double-sided plastic-laminated panels, MDF.

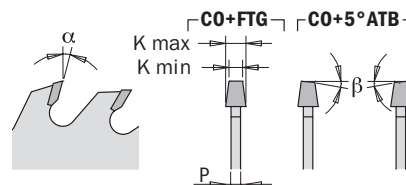
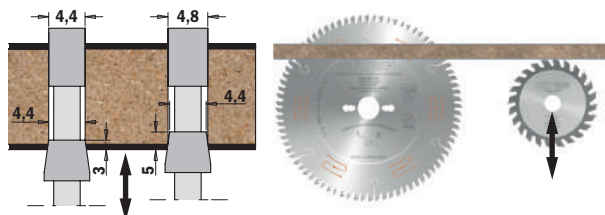
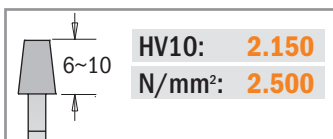

D mm	B mm	PIN HOLE	Z	K mm	P mm	α	β		ORDER NO.	ORDER NO.
80	20		12	3,1-3,6	2,2	10°	CO+FTG	1	Y288.140.24E	288.080.12H
100	20		20	3,1-4,0	2,5	5°	CO+5° ATB	1		288.100.20H
100	22		20	3,1-4,0	2,5	5°	CO+5° ATB	1		288.100.20K
120	20		24	3,1-4,0	2,5	5°	CO+5° ATB	1		288.120.24H
120	20		24	3,4-4,2	2,5	5°	CO+5° ATB	1		288.120.24H1
120	22		24	3,1-4,0	2,5	5°	CO+5° ATB	1		288.120.24K
125	20		24	3,1-4,0	2,5	5°	CO+5° ATB	1		288.125.24H
125	20		24	3,4-4,2	2,5	5°	CO+5° ATB	1		288.125.24H1
125	20		24	4,3-5,5	3,2	10°	CO+FTG	1		288.125.24H2
125	22		24	3,1-4,0	2,5	5°	CO+5° ATB	1		288.125.24K
125	45		24	4,3-5,5	3,2	10°	CO+FTG	1		288.125.24Q
140	16	1/6/33	24	3,1-4,0	2,2	10°	CO+FTG	1	Y288.140.24E	
150	45	3/11/70	36	4,3-5,5	3,2	10°	CO+FTG	1		288.150.36Q
160	45	3/11/70	36	4,3-5,5	3,2	10°	CO+FTG	1		288.160.36Q
160	55	3/7/66 + 3/6/84	36	4,3-5,5	3,2	10°	CO+FTG	1		288.160.360
160	55	3/7/66 + 3/6/84	36	4,7-6,0	3,5	10°	CO+FTG	1	Y288.160.3602	
180	20		36	4,3-5,5	3,2	10°	CO+FTG	1	Y288.180.36H	
180	30		36	4,4-5,3	3,2	10°	CO+FTG	1		288.180.36M
180	45		36	4,3-5,5	3,2	8°	CO+5° ATB	1		288.180.36Q2
180	45		36	4,8-5,6	3,5	10°	CO+FTG	1		288.180.36Q
180	55		36	5,0-6,2	3,5	10°	CO+FTG	1	288.180.360	
180	50	3/12,5/80	44	4,3-5,5	3,2	10°	CO+FTG	1	288.180.44T	
200	20		36	4,4-5,3	3,2	10°	CO+FTG	1		288.200.36H
200	45		36	4,7-6,0	3,5	10°	CO+FTG	1		288.200.36Q
200	45		36	4,3-5,5	3,2	10°	CO+FTG	1		Y288.200.36Q2
200	65	2/9/100 + 2/9/110	36	4,4-5,3	3,2	10°	CO+FTG	1		288.200.36J
215	50	3/15/80	42	4,3-5,5	3,2	8°	CO+FTG	1	288.215.42T	
300	50	3/15/80	48	4,3-5,5	3,2	10°	CO+FTG	1	288.300.48T	
300	65	2/9/100 + 2/9/110	72	4,3-5,5	3,2	10°	CO+FTG	1	288.300.72J	



## 281-282

**APPLICATION:** for sizing single sheets and multiple panels.

**MACHINES:** horizontal panel sizing machines.

**MATERIAL:** single or double-sided plastic-laminated panels, MDF.

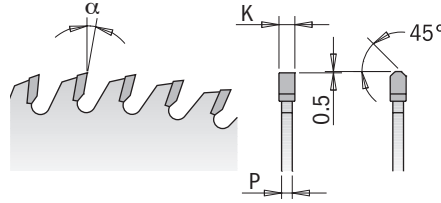
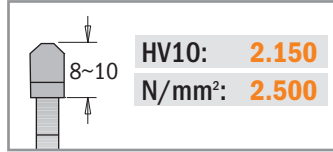

D mm	B mm	PIN HOLE	Z	K mm	P mm	$\alpha$	$\beta$	Low Noise		ORDER NO.	ORDER NO. <b>XTREME</b>
250	30	COMBI3	60	3,2	2,2	10°	TCG		1	281.060.10M	
250	30	COMBI3	80	3,2	2,2	10°	TCG		1	281.080.10M	
300	30	COMBI3	60	4,4	3,2	16°	TCG		1		282.060.12M
300	30	COMBI3	72	3,2	2,2	10°	TCG		5	281.072.12M	
300	30	COMBI3	96	3,2	2,2	10°	TCG		1	281.096.12M	
300	75		60	4,4	3,2	16°	TCG		1		282.060.12X
300	80	COMBI5	60	4,4	3,2	16°	TCG		1	282.060.12W	
320	65	2/9/100 + 2/9/110	60	4,4	3,2	16°	TCG		1		Y282.060.13J
320	65	2/9/100 + 2/9/110	72	4,4	3,2	16°	TCG		1		282.072.13J
350	30	COMBI3	54	4,4	3,2	16°	TCG		1	282.054.14M	
350	30	COMBI3	72	4,4	3,2	16°	TCG		1		282.072.14M
350	30	COMBI3	108	3,5	2,5	10°	TCG		1	281.108.14M	
350	50	3/12,5/80	72	4,4	3,2	16°	TCG		1	282.072.14T	
350	60	2/14/100	72	4,4	3,2	16°	TCG		1	Y282.072.14U	
350	75	4/15/105 + 3/7/100	54	4,4	3,2	16°	TCG		1	282.054.14X	
350	75	4/15/105 + 3/7/100	72	4,4	3,2	16°	TCG		1		282.072.14X
350	80	COMBI5	54	4,4	3,2	16°	TCG		1	282.054.14W	
350	80	COMBI5	72	4,4	3,2	16°	TCG		1		282.072.14W
355	30	2/7/42 + 2/10/60	72	4,4	3,2	16°	TCG		1	S282.03556	
355	65	2/9/100 + 2/9/110	72	4,4	3,2	16°	TCG		1		282.072.14J2
new	355	80	4/9/100 + 2/9/110 + 2/14/110	72	4,4	3,2	16°	TCG	1		282.072.14W2
new	380	60	2/14/100	72	4,4	3,2	15°	TCG	1		282.072.15U2
380	60	COMBI7	72	4,8	3,5	16°	TCG		1		282.072.15U
380	80	COMBI5	72	4,4	3,2	16°	TCG		1	282.072.15W	
400	30	2/10/60	60	4,4	3,2	16°	TCG		1		282.060.16M
400	30	2/10/60	72	4,4	3,2	16°	TCG		1		282.072.16M
400	60	COMBI7	72	4,4	3,2	16°	TCG		1		282.072.16U
400	75	4/15/105	60	4,4	3,2	16°	TCG		1	282.060.16X	
400	75	4/15/105	72	4,4	3,2	16°	TCG		1		282.072.16X
400	80	COMBI5	60	4,4	3,2	16°	TCG		1	282.060.16W	
400	80	COMBI5	72	4,4	3,2	16°	TCG		1		282.072.16W
new	420	80	4/9/100 + 2/9/110 + 2/14/110	72	4,4	3,2	15°	TCG	1		282.072.17W
new	430	65	2/9/100 + 2/9/110	72	4,4	3,2	16°	TCG	1		Y282.072.17J
430	75	4 / 15/105	72	4,4	3,2	16°	TCG		1	282.072.17X	
430	80	COMBI5	72	4,4	3,2	16°	TCG		1		282.072.17W2
new	450	30	2/10/60 + 2/13/94	72	4,4	3,2	16°	TCG	1		Y282.072.18M2
450	60	COMBI7	72	4,8	3,5	16°	TCG		1		282.072.18U
450	80	COMBI5	72	4,8	3,5	16°	TCG		1		282.072.18W2
500	60	COMBI7	72	4,8	3,5	16°	TCG		1		282.072.20U
500	80	COMBI5	72	4,8	3,5	16°	TCG		1	Y282.072.20W	
550	100		72	5,2	3,5	16°	TCG		1	282.072.22A	

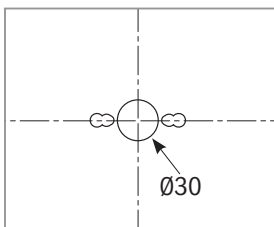

**COMBI3**  
2/7/42mm  
2/9/46,4mm  
2/10/60mm

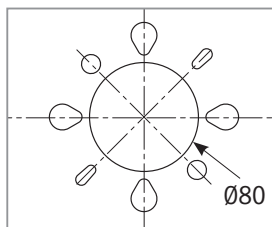

**COMBI5**  
2/7/110mm  
2/8,4/130mm  
2/14/110mm  
4/9/100mm  
4/19/120mm

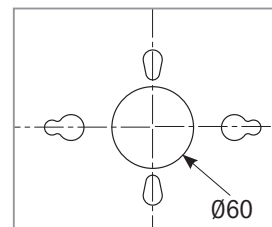

**COMBI7**  
2/10/80mm  
1/11/85mm  
2/11/115mm  
2/11/148mm  
2/14/100mm  
2/14/125mm  
2/19/120mm





## 284

**APPLICATION:** for cutting and dividing tubes, wire drawn products and solid blocks.  
**MACHINES:** table saws, single or double mitre saws with mechanical clamping of the workpiece.  
**MATERIAL:** aluminium, brass, copper alloys, plastic, composite materials.  
**WARNING:** it is recommended to properly clamp the workpiece during cutting operations and to use a liquid lubricant.  
 Wax sticks are NOT RECOMMENDED.

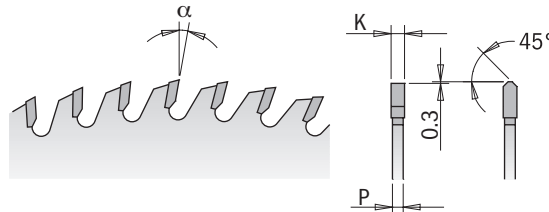
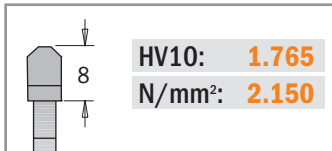

### Saw Blades for Portable Machines. Positive Hook Angle

D mm	B mm	PIN HOLE	Z	K mm	P mm	$\alpha$	$\beta$		ORDER NO.
160	20	-	24	2,2	1,6	5°	TCG	5	<b>284.160.24H</b>
190	30	-	30	2,6	2,2	5°	TCG	5	<b>284.190.30M</b>
216	30	2/7/42	40	2,6	2,2	5°	TCG	5	<b>284.216.40M</b>

**REMARKS:** in plastic carrying case.

### Saw Blades for Industrial Machines. Positive Hook Angle

D mm	B mm	PIN HOLE	Z	K mm	P mm	$\alpha$	$\beta$		ORDER NO.
250	32	2/12/64	80	3,2	2,5	5°	TCG	1	<b>284.080.10P</b>
300	32	2/12/64	96	3,2	2,5	5°	TCG	1	<b>284.096.12P</b>
350	32	2/12/64	92	3,2	2,5	5°	TCG	1	<b>284.092.14P</b>
350	32	2/12/64	108	3,2	2,5	5°	TCG	1	<b>284.108.14P</b>
400	32	2/12/64	96	3,8	3,2	5°	TCG	1	<b>284.096.16P</b>
420	32	2/12/64	96	3,8	3,2	5°	TCG	1	<b>284.096.17P</b>
450	30	2/10/60	108	3,8	3,2	5°	TCG	1	<b>284.108.18M</b>
450	32	2/12/64	108	3,8	3,2	5°	TCG	1	<b>284.108.18P</b>
500	30	2/10/60	120	4,0	3,2	5°	TCG	1	<b>284.120.20M</b>
500	32	2/12/64	120	4,0	3,2	5°	TCG	1	<b>284.120.20P</b>

**REMARKS:** in cardboard box.

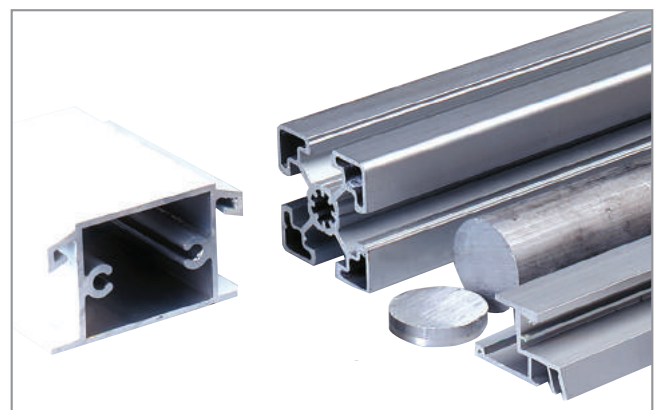
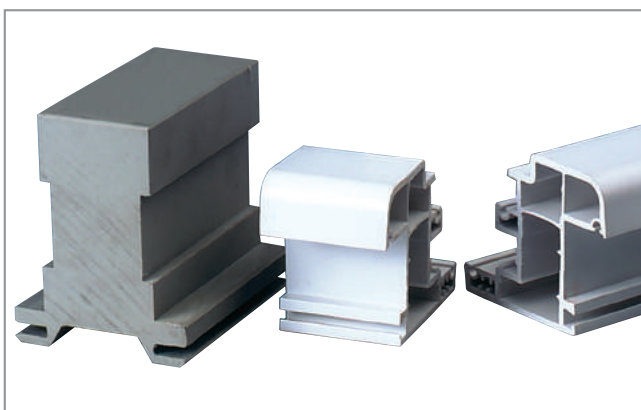



## 296-297

**APPLICATION:** for cutting and dividing tubes, profile/extrusion products and solid blocks.

**MACHINES:** single or double mitre saws, radial saws.  
Use series 296 for portable machines.

**MATERIAL:** aluminium, brass, copper alloys, plastic, composite material, melamine and laminated panels.

**WARNING:** it is recommended to use a liquid lubricant.  
Wax sticks are NOT RECOMMENDED.

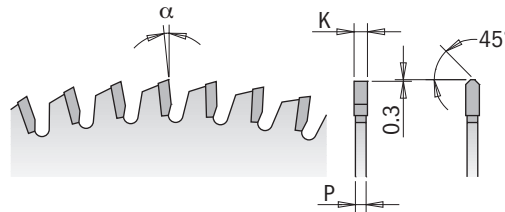
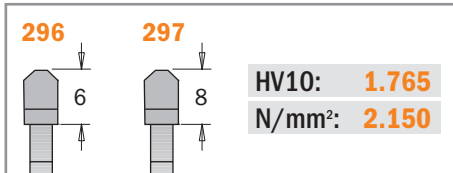

**EXCELLENT**

For All Non-Ferrous Metals & PVC



**GOOD**

Two-Sided Melamine

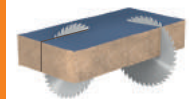

### Saw Blades for Portable Machines & Mitre Saws. Negative Hook Angle

D mm	B mm	PIN HOLE	Z	K mm	P mm	α	β		ORDER NO.
120*	20	2/5,5/30	36	1,8	1,2	-6° Neg.	TCG	5	<b>296.120.36H</b>
160*	20	2/6/32	40	2,2	1,6	-6° Neg.	TCG	5	<b>296.160.40H</b>
160*	20	2/6/32	56	2,2	1,6	-6° Neg.	TCG	5	<b>296.160.56H</b>
165*	20	2/6/32	40	2,2	1,6	-6° Neg.	TCG	5	<b>296.165.40H</b>
165*	20	2/6/32	56	2,2	1,6	-6° Neg.	TCG	5	<b>296.165.56H</b>
180*	20	2/6/32	40	2,8	2,2	-6° Neg.	TCG	5	<b>296.180.40H</b>
190*	30	2/7/42	40	2,8	2,2	-6° Neg.	TCG	5	<b>296.190.40M</b>
190*	30	2/7/42	64	2,8	2,2	-6° Neg.	TCG	5	<b>296.190.64M</b>
190*	20 (Festool® FF)	Key 5/7/2,5	64	2,8	2,2	-6° Neg.	TCG	5	<b>296.190.64FF</b>
200*	30	COMBI3	48	2,8	2,2	-6° Neg.	TCG	5	<b>296.200.48M</b>
210*	30	2/7/42	48	2,8	2,2	-6° Neg.	TCG	5	<b>296.210.48M</b>
210*	30	2/7/42	64	2,8	2,2	-6° Neg.	TCG	5	<b>296.210.64M</b>
216*	30	2/7/42	64	2,8	2,2	-6° Neg.	TCG	5	<b>297.064.09M</b>
216*	30	2/7/42	80	2,8	2,2	-6° Neg.	TCG	5	<b>297.080.09M</b>
225*	30	2/7/42	64	2,8	2,2	-6° Neg.	TCG	5	<b>296.225.64M</b>
230*	30	2/7/42	48	2,8	2,2	-6° Neg.	TCG	5	<b>296.230.48M</b>
235*	30	2/7/42	48	2,8	2,2	-6° Neg.	TCG	5	<b>296.235.48M</b>

\*Non-low noise

**REMARKS:** in plastic carrying case.

### Saw Blades to Fit on Trim & Mitre Saws, Table Saws & Combined Joinery Machines. Negative Hook Angle

D mm	B mm	PIN HOLE	Z	K mm	P mm	α	β		ORDER NO.
250	30	COMBI3	80	3,2	2,5	-6° Neg.	TCG	1	<b>297.080.10M</b>
250	32	2/12/64	80	3,2	2,5	-6° Neg.	TCG	1	<b>297.080.10P</b>
254	30	COMBI3	80	3,2	2,5	-5° Neg.	TCG	1	<b>297.081.10M</b>
260	30	COMBI3	80	2,8	2,2	-6° Neg.	TCG	1	<b>297.080.11M</b>
280*	30	COMBI3	64	3,2	2,5	-6° Neg.	TCG	1	<b>297.064.11M</b>
300	30	COMBI3	96	3,2	2,5	-6° Neg.	TCG	1	<b>297.096.12M</b>
300	32	2/12/64	96	3,2	2,5	-6° Neg.	TCG	1	<b>297.096.12P</b>
305*	30	COMBI3	96	3,2	2,5	-6° Neg.	TCG	1	<b>297.096.13M</b>
315	30	COMBI3	96	3,2	2,5	-6° Neg.	TCG	1	<b>297.096.23M</b>
330	30	COMBI3	96	3,2	2,5	-6° Neg.	TCG	1	<b>297.096.33M</b>
330	32	COMBI3	96	3,2	2,5	-6° Neg.	TCG	1	<b>297.096.33P</b>
350	30	COMBI3	108	3,2	2,5	-6° Neg.	TCG	1	<b>297.108.14M</b>
350	32	4/12/64	108	3,2	2,5	-6° Neg.	TCG	1	<b>297.108.14P</b>
400	30	2/10/60	120	3,8	3,2	-6° Neg.	TCG	1	<b>297.120.16M</b>
400	32	4/12/64	108	3,8	3,2	-6° Neg.	TCG	1	<b>297.108.16P</b>
450	30	2/10/60	140	3,8	3,2	-6° Neg.	TCG	1	<b>Y297.140.18M</b>
450	30	2/10/60	108	3,8	3,2	-6° Neg.	TCG	1	<b>297.108.18M</b>
450	32	2/12/64	108	3,8	3,2	-6° Neg.	TCG	1	<b>297.108.18P</b>
500	30	2/10/60	120	4,0	3,2	-6° Neg.	TCG	1	<b>297.120.20M</b>
500	32	2/12/64	120	4,0	3,2	-6° Neg.	TCG	1	<b>297.120.20P</b>

\*Non-low noise

**REMARKS:** in cardboard box.



## 226

- APPLICATION:** for crosscutting a variety of materials such as iron, steel, pvc, compound materials, melamine.
- MACHINES:** for "dry" crosscutting a variety of materials and ferrous materials such as iron, steel, pvc, compound materials, melamine.
- MATERIAL:** for ferrous materials and structural steel. Max Suggested Hardness HB420/HRC45.
- WARNING:** **not recommended for non-ferrous metals, wood, glass, concrete, plastic.**

**NEW CARBIDE GRADE**

HV10: **1.520**  
N/mm<sup>2</sup>: **2.300**

**FOR BEST RESULTS AND LONGER LIFETIME PLEASE USE THE SUGGESTED RPM IN THE CHART**

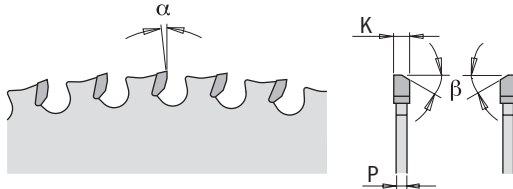

**EXCELLENT** For Iron, Steel, PVC, Compound Materials, Melamine

D mm	B mm	PIN HOLE	RPM suggested	Z	K mm	P mm	α	β		ORDER NO.
136,5*	10		4800	30	1,5	1,2	0°	8° FWF	5	<b>226.030.05</b>
136,5*	20		4800	30	1,5	1,2	0°	8° FWF	5	<b>226.030.05H</b>
150	20		4400	32	1,6	1,2	0°	8° FWF	5	<b>226.032.06H</b>
160	20	2/6/32	4100	30	2,0	1,6	0°	8° FWF	5	<b>226.030.06H</b>
165	15,87<>		4000	36	1,6	1,2	0°	8° FWF	5	<b>226.036.06</b>
165	20	2/6/32	4000	36	1,6	1,2	0°	8° FWF	5	<b>226.036.06H</b>
165	30	2/7/42	4000	36	1,6	1,2	0°	8° FWF	5	<b>226.036.06M</b>
184	15,87<>		3600	48	2,0	1,6	0°	8° FWF	5	<b>226.048.07</b>
190	30	2/7/42	3500	40	2,0	1,6	0°	8° FWF	5	<b>226.040.07M</b>
210	15,87<>		3100	48	2,2	1,8	0°	8° FWF	5	<b>226.048.08</b>
210	30	2/7/42	3100	48	2,2	1,8	0°	8° FWF	5	<b>226.048.08M</b>
216	30	2/7/42	3000	48	2,2	1,8	0°	8° FWF	5	<b>226.047.09M</b>
235	30	2/7/42	2800	48	2,2	1,8	0°	8° FWF	5	<b>226.048.09M</b>
254	15,87		2600	48	2,2	1,8	0°	8° FWF	5	<b>226.048.10</b>
254	15,87		2600	60	2,2	1,8	0°	8° FWF	1	<b>226.060.10</b>
254**	30	COMBI3	2600	60	2,2	1,8	0°	8° FWF	1	<b>226.060.10M</b>
305	25,4		2100	60	2,2	1,8	0°	8° FWF	5	<b>226.060.12</b>
305	25,4		2100	80	2,2	1,8	0°	8° FWF	5	<b>226.080.12</b>
305**	30	COMBI3	2100	80	2,2	1,8	0°	8° FWF	1	<b>226.080.12M</b>
355	25,4		1800	72	2,2	1,8	0°	8° FWF	5	<b>226.072.14</b>
355	25,4		1800	90	2,2	1,8	0°	8° FWF	5	<b>226.090.14</b>
355**	30	COMBI3	1800	90	2,2	1,8	0°	8° FWF	1	<b>226.090.14M</b>

\*Non-low noise

\*\*REMARKS: in cardboard box.

## **X-TREME** Saw Blades for Stainless Steel

**MATERIAL:** for stainless steel, studs and galvanized stuff. Max Suggested Hardness HB420/HRC45.

**NEW CERMET GRADE**

HV10: **1.600**  
N/mm<sup>2</sup>: **2.000**

**SPECIAL CARBIDE**  
**CERMET**



D mm	B mm	PIN HOLE	RPM suggested	Z	K mm	P mm	α	β		ORDER NO.
160	20	2/6/32	4100	40	1,8	1,4	0°	8° FWF	1	<b>226.540.06H</b>
184	15,87<>		3600	48	2,0	1,6	0°	8° FWF	1	<b>226.548.07</b>
190	30	2/7/42	3500	48	1,8	1,4	0°	8° FWF	1	<b>226.548.07M</b>
216	30	2/7/42	3000	56	1,8	1,4	0°	8° FWF	1	<b>226.556.09M</b>
250**	30	COMBI3	2600	72	2,2	1,8	0°	8° FWF	1	<b>226.572.10M</b>
254	15,87		2600	72	2,2	1,8	0°	8° FWF	1	<b>226.572.10</b>
300**	30	COMBI3	2200	80	2,2	1,8	0°	8° FWF	1	<b>226.580.12M</b>
305	25,4		2100	80	2,2	1,8	0°	8° FWF	1	<b>226.580.12</b>
355	25,4		1800	90	2,2	1,8	0°	8° FWF	1	<b>226.590.14</b>
355**	30	COMBI3	1800	90	2,2	1,8	0°	8° FWF	1	<b>226.590.14M</b>

\*\*REMARKS: in cardboard box.



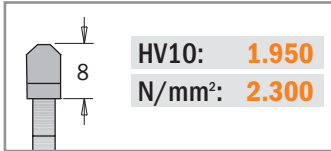

**223**

**APPLICATION:** for swirl free cuts.  
**MACHINES:** table saws and panel sizing.  
**MATERIAL:** solid surface materials (DuPont™ Corian®, Wilsonart®, Gibraltar®, SSV Fountainhead®, Varicor®, etc.) and thick plastic.  
**WARNING:** not recommended for use on mitre saws.

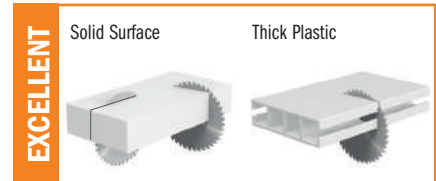
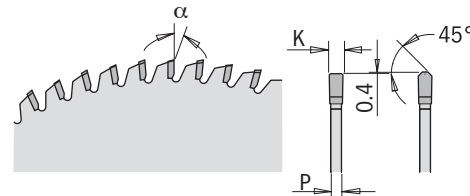

D mm	B mm	PIN HOLE	Z	K mm	P mm	$\alpha$	$\beta$		ORDER NO.
160	20	2/6/32	48	2,2	1,6	0°	MTCG	5	<b>223.048.06H</b>
250	30	COMBI3	72	3,2	2,5	0°	MTCG	1	<b>223.072.10M</b>
300	30	COMBI3	84	3,2	2,5	0°	MTCG	1	<b>223.084.12M</b>

new

PVC & Plexiglass Saw Blades *Industrial Line*

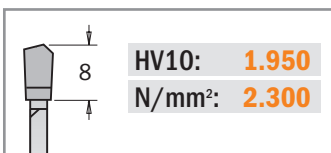

**222**

**APPLICATION:** for perfect cuts without melting and scratching.  
**MACHINES:** table saws, panel sizing and mitre saws.  
**MATERIAL:** thin plastic, plexiglass, vinyl, plywood, laminated flooring.

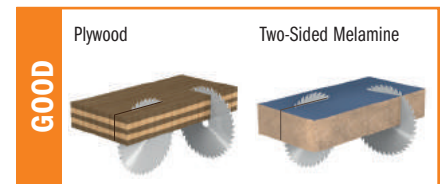
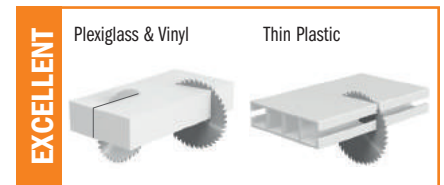
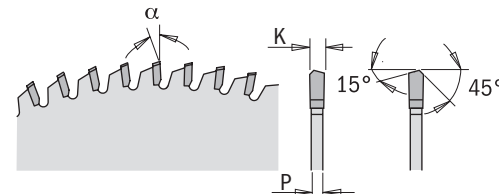

D mm	B mm	PIN HOLE	Z	K mm	P mm	$\alpha$	$\beta$		ORDER NO.
250	30	COMBI3	80	2,8	2,2	-3° Neg.	MATB	1	<b>222.080.10M</b>
300	30	COMBI3	96	2,8	2,2	-3° Neg.	MATB	1	<b>222.096.12M</b>

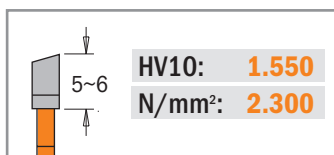

## 271

**APPLICATION:** for rip cuts at high-speed rotation. The blade considerably reduces material waste thanks to the thin-kerf design. Particularly suitable for valuable wood.

**MACHINES:** miter saws, table saws, portable and cordless saws.

**MATERIAL:** soft and hardwood.

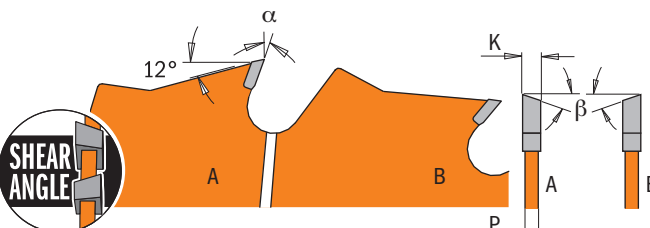
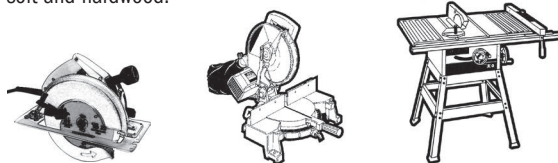

D mm	B mm	PIN HOLE	Z	K mm	P mm	α	β		ORDER NO.
250	30	COMBI3	24	2,4	1,6	20°	10° ATB + 8° Shear	10	<b>271.250.24M</b>
300	30	COMBI3	24	2,6	1,8	22°	10° ATB + 8° Shear	5	<b>271.300.24M</b>

# ITK-Plus® Rip & Crosscut Saw Blades

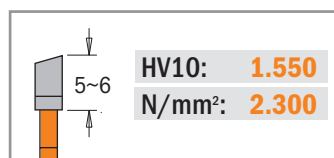

## 271

**APPLICATION:** for rip and crosscuts at high-speed rotation. The blade considerably reduces material waste thanks to the thin-kerf design. Particularly suitable for valuable wood.

**MACHINES:** miter saws, table saws, portable and cordless saws.

**MATERIAL:** soft and hardwood, plywood.

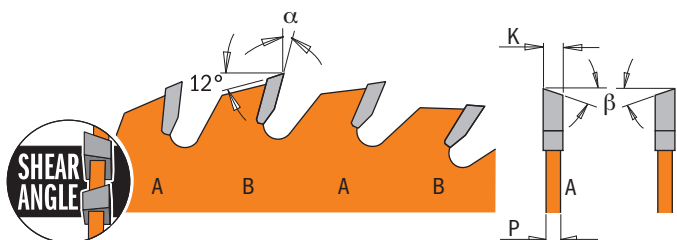
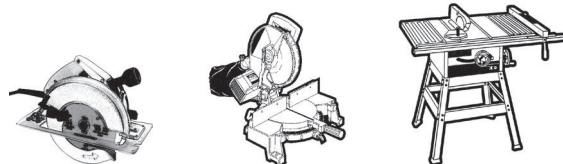

D mm	B mm	PIN HOLE	Z	K mm	P mm	α	β		ORDER NO.
136	20 (+10)		18	1,5	1,0	20°	10° ATB + 8° Shear	10	<b>271.136.18H</b>
150	20 (+16)		24	1,5	1,0	18°	10° ATB + 8° Shear	10	<b>271.150.24H</b>
160	20 (+16)	2/6/32	24	1,8	1,2	18°	10° ATB + 8° Shear	10	<b>271.160.24H</b>
165	20 (+15,87)	2/6/32	24	1,7	1,1	18°	10° ATB + 8° Shear	10	<b>271.165.24H</b>
165	30	2/7/42	24	1,7	1,1	18°	10° ATB + 8° Shear	10	<b>271.165.24M</b>
184	20 (+16+15,87)	2/7/42	24	1,7	1,1	20°	10° ATB + 8° Shear	10	<b>271.184.24H</b>
184	30	2/7/42	24	1,7	1,1	20°	10° ATB + 8° Shear	10	<b>271.184.24M</b>
190	30 (+20+16)	2/7/42	24	1,7	1,1	20°	10° ATB + 8° Shear	10	<b>271.190.24M</b>
200	30	2/7/42	36	1,8	1,2	15°	10° ATB + 8° Shear	10	<b>271.200.36M</b>
210	30 (+25)	2/7/42	24	1,8	1,2	20°	10° ATB + 8° Shear	10	<b>271.210.24M</b>
210	30 (+25)	2/7/42	36	1,8	1,2	15°	10° ATB + 8° Shear	10	<b>271.210.36M</b>
216	30	2/7/42	36	1,8	1,2	-5° Neg.	10° ATB + 8° Shear	10	<b>271.216.36M</b>
235	30 (+25)	2/7/42	36	2,4	1,6	18°	10° ATB + 8° Shear	10	<b>271.235.36M</b>
250	30	COMBI3	42	2,4	1,6	18°	10° ATB + 8° Shear	10	<b>271.250.42M</b>
300	30	COMBI3	48	2,6	1,8	18°	10° ATB + 8° Shear	5	<b>271.300.48M</b>
305	30	COMBI3	48	2,6	1,8	-5° Neg.	ATB	5	<b>271.305.48M</b>

# ITK-Plus® Crosscut Saw Blades



## 272

**APPLICATION:** for rip and crosscuts at high-speed rotation. The blade considerably reduces material waste thanks to the thin-kerf design. Particularly suitable for valuable wood.

**MACHINES:** miter saws, table saws, portable and cordless saws.

**MATERIAL:** soft and hardwood, plywood.

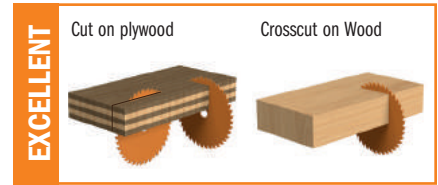
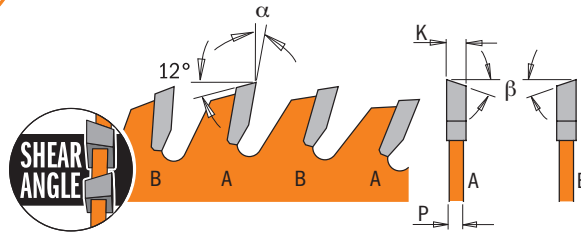
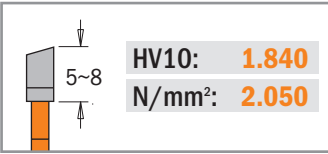
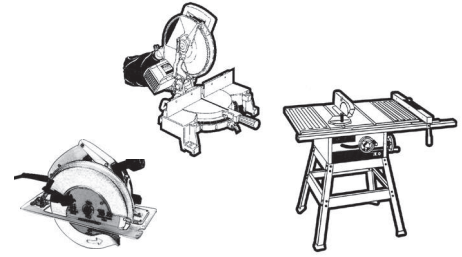

D mm	B mm	PIN HOLE	Z	K mm	P mm	$\alpha$	$\beta$		ORDER NO.
136	20 (+10)		36	1,5	1,0	18°	10° ATB + 8° Shear	10	272.136.36H
150	20 (+16)		40	1,5	1,0	16°	10° ATB + 8° Shear	10	272.150.40H
160	20 (+16)	2/6/32	40	1,8	1,2	16°	10° ATB + 8° Shear	10	272.160.40H
165	20 (+15,87)	2/6/32	36	1,7	1,1	20°	10° ATB + 8° Shear	10	272.165.36H
184	20 (+16+15,87)	2/7/42	40	1,7	1,1	18°	10° ATB + 8° Shear	10	272.184.40H
184	30	2/7/42	40	1,7	1,1	18°	10° ATB + 8° Shear	10	272.184.40M
190	30 (+20+16)	2/7/42	42	1,7	1,1	18°	10° ATB + 8° Shear	10	272.190.42M
200	30	2/7/42	48	1,8	1,2	15°	10° ATB + 8° Shear	10	272.200.48M
210	30 (+25)	2/7/42	48	1,8	1,2	15°	10° ATB + 8° Shear	10	272.210.48M
216	30	2/7/42	48	1,8	1,2	-5° Neg.	10° ATB + 8° Shear	10	272.216.48M
235	30 (+25)	2/7/42	48	2,4	1,6	18°	10° ATB + 8° Shear	10	272.235.48M
250	30	COMBI3	60	2,4	1,6	15°	10° ATB + 8° Shear	10	272.250.60M
300	30	COMBI3	72	2,6	1,8	15°	10° ATB + 8° Shear	5	272.300.72M
305	30	COMBI3	72	2,6	1,8	-5° Neg.	ATB	5	272.305.72M

# ITK-Plus® Fine Cut-Off Saw Blades



## 273

**APPLICATION:** for crosscuts and finish cuts. The blade considerably reduces material waste thanks to the thin-kerf design. Particularly suitable for precious wood.

**MACHINES:** miter saws, table saws, portable and cordless saws.

**MATERIAL:** soft and hardwood, exotic wood, plywood and laminates.

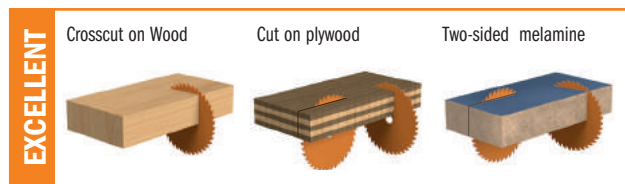
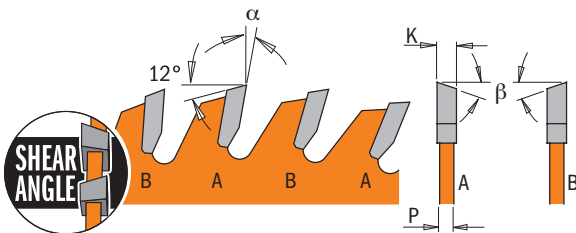
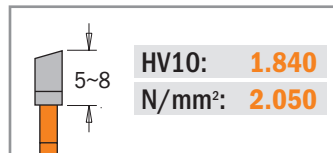
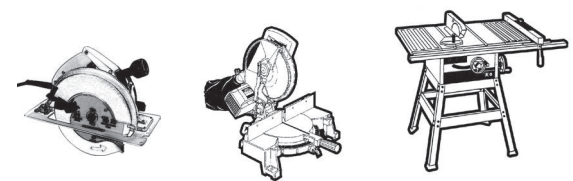

D mm	B mm	PIN HOLE	Z	K mm	P mm	$\alpha$	$\beta$		ORDER NO.
160	20 (+16)	2/6/32	56	1,8	1,2	12°	10° ATB + 8° Shear	10	273.160.56H
190	30 (+20+16)	2/7/42	64	1,7	1,1	15°	10° ATB + 8° Shear	10	273.190.64M
216	30	2/7/42	64	1,8	1,2	-5° Neg.	10° ATB + 8° Shear	10	273.216.64M
250	30	COMBI3	80	2,4	1,6	12°	10° ATB + 8° Shear	10	273.250.80M
300	30	COMBI3	96	2,6	1,8	12°	10° ATB + 8° Shear	5	273.300.96M





**276**

**APPLICATION:** for heavy-duty cutting, excellent on thin-walled extrusions, good on thick-walled extrusions.  
**MACHINES:** radial arm saws, miter saws, table and special saws.  
**MATERIAL:** aluminum, brass, copper, PVC, non-ferrous metals and composite decking.

**EXCELLENT** For All Non-Ferrous Metal and PVC Double-Sided Laminate Composite Decking

TREX®  
TIMBERTECH®  
AZEK®  
VERANDA®  
CHOICEDECK®

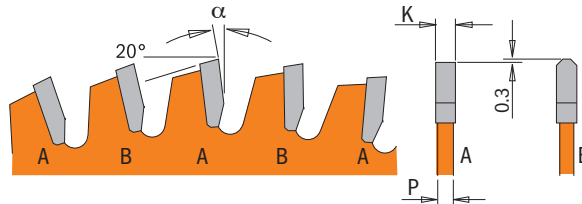
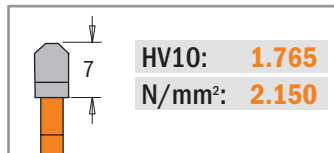

D mm	B mm	PIN HOLE	Z	K mm	P mm	α	β		ORDER NO.
160	20 (16)	2/6/32	48	1,8	1,2	-6° Neg.	TCG	10	<b>276.160.48H</b>
184	20 (16-15,87)	2/7/42	48	1,8	1,2	-6° Neg.	TCG	10	<b>276.184.48H</b>
190	20 (20-16)	2/7/42	64	1,8	1,2	-6° Neg.	TCG	10	<b>276.190.64M</b>
210	30 (25)	2/7/42	64	1,8	1,2	-6° Neg.	TCG	10	<b>276.210.64M</b>
216	30	2/7/42	64	2,2	1,6	-6° Neg.	TCG	10	<b>276.216.64M</b>
250	30	COMBI3	80	2,6	1,8	-6° Neg.	TCG	10	<b>276.250.80M</b>
300	30	COMBI3	96	2,8	2,0	-6° Neg.	TCG	10	<b>276.300.96M</b>
305	30	COMBI3	96	2,8	2,0	-6° Neg.	TCG	10	<b>276.305.96M</b>

Garden Trimmer Saw Blades



**298**

**APPLICATION:** for cutting grass, bushes and small trees.  
**MACHINES:** hedge trimmers.  
**MATERIAL:** grass, bushes and small trees.  
**WARNING:** always wear safety glasses and ear protection. Carefully read the safety recommendations provided for this product.



Bushes & Small Trees  
(up to a diameter of Ø5 cm)



Grass

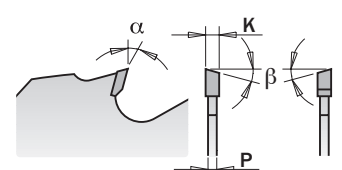
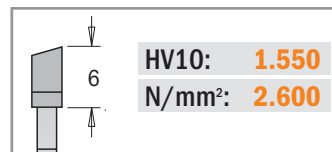
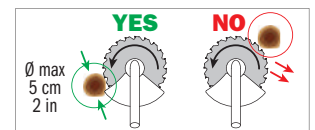

D mm	B mm	RPM max	Z	K mm	P mm	α	β		ORDER NO.
250	20	12.000	20	2,2	1,4	15°	10° ATB	10	<b>298.250.20H</b>
250	25,4	12.000	20	2,2	1,4	15°	10° ATB	10	<b>298.250.20</b>

# DP Saw Blades for Ultra-Hard Materials



## 236

**APPLICATION:** for rip and crosscuts on abrasive materials.  
**MACHINES:** mitre saws, portable and cordless machines.  
**MATERIAL:** Eternit®, Swisspearl®, Femacell®, Ivarplank®, HardiePlank®, HardiePanel®, Corian®, Duroplast®, Formica® and other generic panels such as chipboard, MDF plasterboard and thermoplastic.

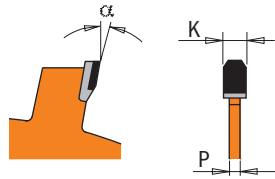

**GOOD**

Eternit®, Swisspearl®, Femacell®, Ivarplank®, HardiePlank®, HardiePanel®, Corian®, Duroplast®, Formica®, and other generic panel such as chipboard, MDF, plasterboard and thermoplastic.

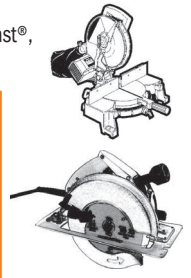

D mm	B mm	PIN HOLE	Z	K mm	P mm	$\alpha$	$\beta$		ORDER NO.
85	15		6	1,8	1,4	12°	TCG	10	236.085.06G
125	22,23		7	2,0	1,4	5°	TCG	10	236.125.07
160	20	2/6/32	4	2,4	1,8	12°	TCG	10	236.160.04H
160	20	2/6/32	10	2,4	1,8	5°	TCG	10	236.160.10H
165	20 (+15,87)	2/6/32	4	1,8	1,4	12°	TCG	10	236.165.04H
165	20 (+15,87)	2/6/32	10	1,8	1,4	5°	TCG	10	236.165.10H
180	20	2/6/32	4	2,4	1,8	12°	TCG	10	236.180.04H
190	30	2/7/42	4	2,4	1,8	12°	TCG	10	236.190.04M
190	30	2/7/42	12	2,4	1,8	12°	TCG	10	236.190.12M
210	30	2/7/42	12	2,4	1,8	12°	TCG	10	236.210.12M
216	30	2/7/42	14	2,4	1,8	12°	TCG	10	236.216.14M
230	30	2/7/42	4	2,4	1,8	12°	TCG	10	236.230.04M
250	30	COMBI3	16	2,4	1,8	12°	TCG	10	236.250.16M
300	30	COMBI3	20	2,4	1,8	12°	TCG	5	236.300.20M

# Rip Saw Blades for Portable Machines



## 290

**APPLICATION:** for rip cuts.  
**MACHINES:** mitre saws and portable machines.  
**MATERIAL:** soft and hardwood.

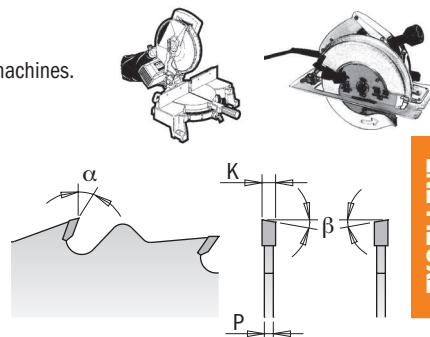
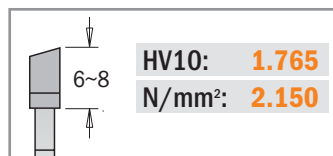

**EXCELLENT**

Rip Cut on Wood

D mm	B mm	PIN HOLE	Z	K mm	P mm	$\alpha$	$\beta$		ORDER NO.
150	20		12	2,4	1,4	20°	10° ATB	5	290.150.12H
160	16		12	2,2	1,6	20°	10° ATB	5	290.160.12E
160	20	2/6/32	12	2,2	1,6	20°	10° ATB	5	290.160.12H
180	30	2/7/42	12	2,6	1,6	20°	10° ATB	5	290.180.12M
190	16	2/6/32	12	2,6	1,6	20°	10° ATB	5	290.190.12E
190	20	2/6/32	12	2,6	1,6	20°	10° ATB	5	290.190.12H
190	30	2/7/42	12	2,6	1,6	20°	10° ATB	5	290.190.12M
200	30	2/7/42	24	2,8	1,8	20°	10° ATB	5	290.200.24M
210	25		24	2,8	1,8	20°	10° ATB	5	290.210.24L
210	30	2/7/42	24	2,8	1,8	20°	10° ATB	5	290.210.24M
216	30	2/7/42	24	2,8	1,8	-5° Neg.	15° ATB	5	290.216.24M
220	30	2/7/42	24	2,8	1,8	20°	10° ATB	5	290.220.24M
230	30	2/7/42	24	2,8	1,8	20°	10° ATB	5	290.230.24M
235	25		24	2,8	1,8	20°	10° ATB	5	290.235.24L
235	30	2/7/42	24	2,8	1,8	20°	10° ATB	5	290.235.24M
240	30	2/7/42	24	2,8	1,8	20°	10° ATB	5	290.240.24M
250	30	COMBI3	24	2,8	1,8	20°	10° ATB	5	290.250.24M*
260	30	COMBI3	28	2,8	1,8	20°	10° ATB	1	290.260.28M*
270	30	2/7/42	28	2,8	1,8	20°	10° ATB	5	290.270.28M*

\* Industrial quality



## 285-291

**APPLICATION:** for rip and crosscuts.  
**MACHINES:** table and mitre saws, portable machines.  
**MATERIAL:** soft and hardwood, plywood.

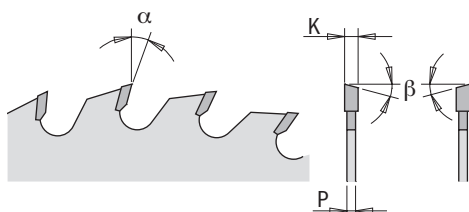
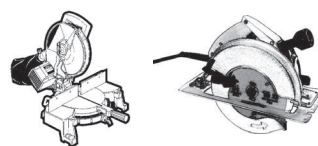
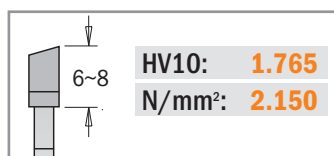

D mm	B mm	PIN HOLE	Z	K mm	P mm	α	β		ORDER NO.
120	20	2/5,5/30	18	1,8	1,2	15°	15° ATB	5	<b>291.120.18H*</b>
125	20		20	2,4	1,4	15°	15° ATB	5	<b>291.125.20H</b>
130	20		20	2,4	1,4	15°	15° ATB	5	<b>291.130.20H</b>
140	20		20	2,4	1,4	15°	15° ATB	5	<b>291.140.20H</b>
150	16		24	2,4	1,4	15°	15° ATB	5	<b>291.150.24E</b>
150	20		24	2,4	1,4	15°	15° ATB	5	<b>291.150.24H</b>
160	16		24	2,2	1,6	15°	15° ATB	5	<b>291.160.24E</b>
160	20	2/6/32	24	2,2	1,6	15°	15° ATB	5	<b>291.160.24H</b>
160	30	2/7/42	24	2,2	1,6	15°	15° ATB	5	<b>291.160.24M</b>
165	20	2/6/32	24	2,2	1,6	15°	15° ATB	5	<b>291.165.24H</b>
165	30	2/7/42	24	2,6	1,6	15°	15° ATB	5	<b>291.165.24M</b>
170	30	2/7/42	24	2,6	1,6	20°	10° ATB	5	<b>291.170.24M</b>
180	20	2/6/32	24	2,6	1,6	20°	10° ATB	5	<b>291.180.24H</b>
180	30	2/7/42	24	2,6	1,6	20°	10° ATB	5	<b>291.180.24M</b>
184	16		24	2,6	1,6	20°	10° ATB	5	<b>291.184.24E</b>
184	30		24	2,6	1,6	20°	10° ATB	5	<b>291.184.24M</b>
190	16	2/6/32	24	2,6	1,6	20°	10° ATB	5	<b>291.190.24E</b>
190	20	2/6/32	24	2,6	1,6	20°	10° ATB	5	<b>291.190.24H</b>
190	30	2/7/42	24	2,6	1,6	20°	10° ATB	5	<b>291.190.24M</b>
190	20 (Festool® FF)	Key 5/7/2,5	32	2,6	1,8	10°	10° ATB	5	<b>291.190.32FF</b>
200	30	2/7/42	36	2,8	1,8	15°	15° ATB	5	<b>291.200.36M</b>
210	25		36	2,8	1,8	15°	15° ATB	5	<b>291.210.36L</b>
210	30	2/7/42	36	2,8	1,8	15°	15° ATB	5	<b>291.210.36M</b>
216	30	2/7/42	48	2,8	1,8	-5° Neg.	15° ATB	5	<b>291.216.48M</b>
220	30	2/7/42	36	2,8	1,8	15°	15° ATB	5	<b>291.220.36M</b>
225	30	2/7/42	36	2,8	1,8	20°	15° ATB	5	<b>291.225.36M</b>
230	30	2/7/42	36	2,8	1,8	15°	15° ATB	5	<b>291.230.36M</b>
235	25		36	2,8	1,8	15°	15° ATB	5	<b>291.235.36L</b>
235	30	2/7/42	36	2,8	1,8	15°	15° ATB	5	<b>291.235.36M</b>
240	30	2/7/42	36	2,8	1,8	15°	15° ATB	5	<b>291.240.36M</b>
250	20	COMBI3	40	3,2	2,2	15°	10° ATB	1	<b>285.040.10H*</b>
250	30	COMBI3	40	3,2	2,2	15°	10° ATB	1	<b>285.040.10M*</b>
260	30	2/10/60 + 2/7/42	48	2,8	1,8	15°	10° ATB	1	<b>285.048.11M*</b>
270	30	2/7/42	42	2,8	1,8	20°	10° ATB	5	<b>291.270.42M*</b>

\* Industrial quality



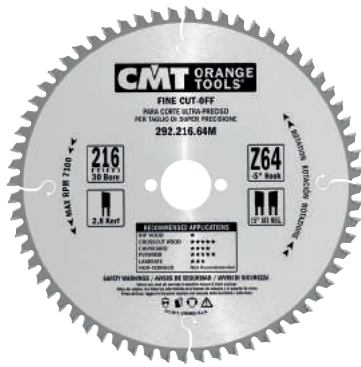

## 281-285-292

**APPLICATION:** for crosscuts, perfect finishing.

**MACHINES:** table and mitre saws, portable machines.

**MATERIAL:** soft, hard and exotic wood, wood-based panels, single-sided veneer, paper-based laminates.

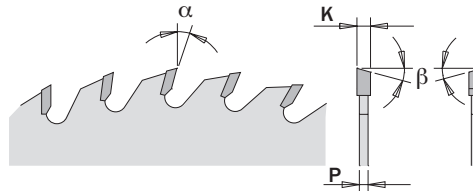
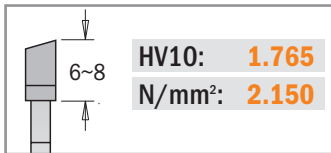
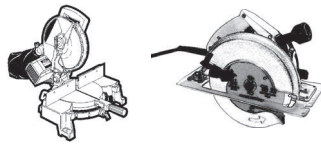

D mm	B mm	PIN HOLE ⊕ ⊗	Z	K mm	P mm	α	β		ORDER NO.
120	20	2/5,5/30	36	1,8	1,2	10°	15° ATB	5	<b>292.120.36H*</b>
120	20	2/5,5/30	40	1,8	1,2	10°	15° ATB	5	<b>292.120.40H</b>
125	20	-	36	2,4	1,4	15°	15° ATB	5	<b>292.125.36H</b>
130	20	-	36	2,4	1,4	15°	15° ATB	5	<b>292.130.36H</b>
140	20	-	36	2,4	1,4	15°	15° ATB	5	<b>292.140.36H</b>
150	20	-	40	2,4	1,4	15°	15° ATB	5	<b>292.150.40H</b>
150	30	2/7/42	48	3,2	2,2	5°	15° ATB	5	<b>285.048.06M*</b>
160	16	-	40	2,2	1,6	10°	15° ATB	5	<b>292.160.40E</b>
160	20	2/6/32	40	2,2	1,6	10°	15° ATB	5	<b>292.160.40H</b>
160	20 (Virutex)	4/7/32 (45°)	40	2,2	1,6	10°	TCG	5	<b>281.160.40H*</b>
160	20	2/6/32	40	2,2	1,6	10°	TCG	5	<b>281.160.40H2*</b>
160	30	2/7/42	40	2,2	1,6	10°	15° ATB	5	<b>292.160.40M</b>
160	20	2/6/32	48	2,2	1,6	5°	15° ATB	5	<b>285.160.48H</b>
160	20	2/6/32	56	2,2	1,6	15°	15° ATB	5	<b>292.160.56H</b>
165	20	2/6/32	40	2,2	1,6	10°	15° ATB	5	<b>292.165.40H</b>
165	20	2/6/32	56	2,2	1,6	15°	15° ATB	5	<b>292.165.56H</b>
165	30	2/7/42	40	2,6	1,6	10°	15° ATB	5	<b>292.165.40M</b>
170	30	2/7/42	40	2,6	1,6	15°	15° ATB	5	<b>292.170.40M</b>
180	20	2/6/32	40	2,6	1,6	15°	15° ATB	5	<b>292.180.40H</b>
180	30	2/7/42	40	2,6	1,6	15°	15° ATB	5	<b>292.180.40M</b>
180	30	2/7/42	56	3,2	2,2	5°	15° ATB	5	<b>285.056.07M*</b>
184	16	-	40	2,6	1,6	15°	15° ATB	5	<b>292.184.40E</b>
184	30	-	40	2,6	1,6	15°	15° ATB	5	<b>292.184.40M</b>
190	16	2/6/32	40	2,6	1,6	15°	15° ATB	5	<b>292.190.40E</b>
190	20	2/6/32	40	2,6	1,6	15°	15° ATB	5	<b>292.190.40H</b>
190	30	2/7/42	40	2,6	1,6	15°	15° ATB	5	<b>292.190.40M</b>
190	30	2/7/42	64	2,6	1,6	15°	15° ATB	5	<b>292.190.64M</b>
190	20 (Festool® FF)	5/7/2,5	48	2,4	1,8	10°	15° ATB	5	<b>292.190.48FF</b>
200	30	2/7/42	48	2,8	1,8	15°	15° ATB	5	<b>292.200.48M</b>
210	25	-	48	2,8	1,8	15°	15° ATB	5	<b>292.210.48L</b>
210	30	2/7/42	48	2,8	1,8	15°	15° ATB	5	<b>292.210.48M</b>
210	30	2/7/42	64	2,8	1,8	15°	15° ATB	5	<b>292.210.64M</b>
216	30	2/7/42	64	2,8	1,8	-5° Neg.	15° ATB	5	<b>292.216.64M</b>
216	30	2/7/42	80	2,8	1,8	-5° Neg.	15° ATB	5	<b>292.216.80M</b>
220	30	2/7/42	48	2,8	1,8	15°	15° ATB	5	<b>292.220.48M</b>
225	30	2/7/42	48	2,8	1,8	10°	15° ATB	5	<b>292.225.48M</b>
230	30	2/7/42	48	2,8	1,8	15°	15° ATB	5	<b>292.230.48M</b>
230	30	2/7/42+2/10/60	64	2,8	1,8	15°	15° ATB	5	<b>292.230.64M</b>
235	25	-	48	2,8	1,8	15°	15° ATB	5	<b>292.235.48L</b>
235	30	2/7/42	48	2,8	1,8	15°	15° ATB	5	<b>292.235.48M</b>
240	30	2/7/42	48	2,8	1,8	15°	15° ATB	5	<b>292.240.48M</b>
250	30	COMBI3	60	3,2	2,2	10°	15° ATB	1	<b>285.060.10M*</b>
260	30	2/10/60 + 2/7/42	60	2,8	1,8	10°	15° ATB	5	<b>285.060.11M*</b>

\* Industrial quality



## K (CMT Contractor Tools®)

**MACHINES:** portable benchtop and table saws.  
**MATERIAL:** soft/hard wood, plywood, OSB panels.

*Designed for construction, remodeling and DIY projects. These blades deliver solid performance at a very economical price.*



Kit 10 pcs.

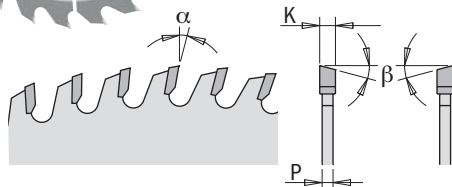

DESCRIPTION	D mm	B mm	PIN HOLE	Z	K mm	P mm	α	β		ORDER NO.
Fine cut-off (clamshell)	85	15		24	1,1	0,7	12°	5° ATB	10	<b>K02403</b>
Crosscut (pack 10 blades)	136	20		18	1,5	1,0	15°	15° ATB	5	<b>K13618H-X10</b>
Fine cut-off (pack 10 blades)	160	20	2/6/32	24	2,2	1,4	15°	15° ATB	5	<b>K16024H-X10</b>
Crosscut (pack 10 blades)	160	20	2/6/32	40	2,2	1,4	10°	15° ATB	5	<b>K16040H-X10</b>
Crosscut (pack 10 blades)	165	20	2/6/32	24	1,7	1,1	15°	15° ATB	5	<b>K16524H-X10</b>
Crosscut (pack 10 blades)	190	30	2/7/42	24	2,2	1,4	20°	10° ATB	5	<b>K19024M-X10</b>
Crosscut (pack 10 blades)	216	30	2/7/42	24	2,4	1,6	-5° Neg.	15° ATB	5	<b>K21624M-X10</b>
Crosscut (pack 10 blades)	216	30	2/7/42	48	2,4	1,6	-5° Neg.	15° ATB	5	<b>K21648M-X10</b>
Crosscut (pack 5 blades)	250	30	COMBI3	40	2,6	1,8	15°	10° ATB	5	<b>K25040M-X05</b>



## CMT Contractor Tools® Saw Blade Combo

### K (CMT Contractor Tools®)

**MACHINES:** portable benchtop and table saws.  
**MATERIAL:** soft/hard wood, plywood, OSB panels.

*Designed for construction, remodeling and DIY projects. These blades deliver solid performance at a very economical price.*



#### **K160H-X03** 3-pc Set for Crosscut & Fine Cut Circular Saw Blades Ø160mm. Bore 20mm.

**MASTERPACK 10**

DESCRIPTION	SET CONTAINS ORDER No.	D mm	B mm	PIN HOLE	Z	K mm	P mm	α	β
Crosscut	K16024H (1pc.)	160	20	2/6/32	24	2,2	1,4	15°	15° ATB
Fine cut-off	K16040H (2pc.)	160	20	2/6/32	40	2,2	1,4	10°	15° ATB

#### **K190M-X03** 3-pc Set for Crosscut & Fine Cut Circular Saw Blades Ø190mm. Bore 30mm.

**MASTERPACK 10**

DESCRIPTION	SET CONTAINS ORDER No.	D mm	B mm	PIN HOLE	Z	K mm	P mm	α	β
Crosscut	K19024M (2pc.)	190	30	2/7/42	24	2,2	1,4	20°	10° ATB
Fine cut-off	K19040M (1pc.)	190	30	2/7/42	40	2,2	1,4	15°	10° ATB

#### **K216M-X03** 3-pc Set for Crosscut & Fine Cut Circular Saw Blades Ø216mm. Bore 30mm.

**MASTERPACK 10**

DESCRIPTION	SET CONTAINS ORDER No.	D mm	B mm	PIN HOLE	Z	K mm	P mm	α	β
Crosscut	K21624M (1pc.)	216	30	2/7/42	24	2,4	1,6	-5° Neg.	15° ATB
Fine cut-off	K21648M (2pc.)	216	30	2/7/42	48	2,4	1,6	-5° Neg.	15° ATB

#### **K250M-X02** 2-pc Set for Rip & Crosscut Circular Saw Blades Ø250mm. Bore 30mm.

**MASTERPACK 10**

DESCRIPTION	SET CONTAINS ORDER No.	D mm	B mm	PIN HOLE	Z	K mm	P mm	α	β
Rip	K25024M (1pc.)	250	30	COMBI3	24	2,6	1,8	20°	10° ATB
Crosscut	K25040M (1pc.)	250	30	COMBI3	40	2,6	1,8	15°	10° ATB

#### **K305M-X02** 2-pc Set for Crosscut & Fine Cut Circular Saw Blades Ø305mm. Bore 30mm.

**MASTERPACK 5**

DESCRIPTION	SET CONTAINS ORDER No.	D mm	B mm	PIN HOLE	Z	K mm	P mm	α	β
Crosscut	K30540M (1pc.)	305	30	COMBI3	40	2,8	2,0	-5° Neg.	10° ATB
Fine cut-off	K30560M (1pc.)	305	30	COMBI3	60	2,8	2,0	-5° Neg.	10° ATB

# Dado Saw Blades



**230** CMT thoroughly researched the shortcomings of "standard" dado sets and learned what cabinet makers required most from an "ideal" dado.

The result was the superior CMT precision dado, designed with the following features:

- anti-kickback design to reduce the possibility of overfeeding that can occur when cutting mass material.
- splinter resistant cuts in veneer plywood, melamine and hard and soft woods;
- shim sets included for cuts between 6,35mm (1/4") and 22,23mm (7/8").

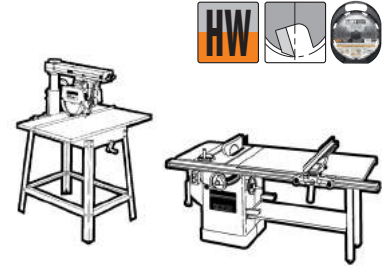
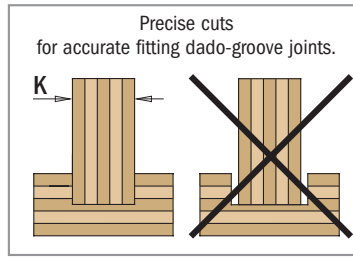

### Precision Dado set includes:

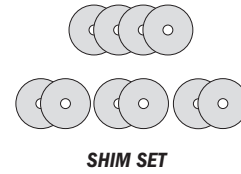
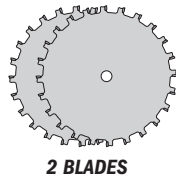

Shims set contains	
No.	Shim Width
4	0.1mm
2	0.2mm
2	0.3mm
2	0.5mm

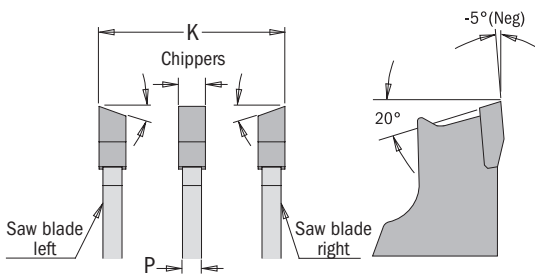
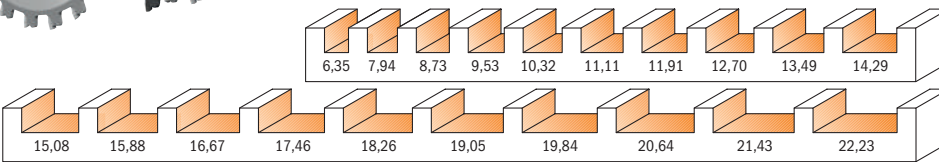

K mm	Number of required inside blades		
	1,6mm	2,4mm	3,2mm
6,35	0	0	0
7,94	1	0	0
8,73	0	1	0
9,53	0	0	1
10,32	1	1	0
11,11	1	0	1
11,91	0	1	1
12,70	0	0	2
13,49	1	1	1
14,29	1	0	2
15,08	0	1	2
15,88	0	0	3
16,67	1	1	2
17,46	1	0	3
18,26	0	1	3
19,05	0	0	4
19,84	1	1	3
20,64	1	0	4
21,43	0	1	4
22,23	1	1	4

D mm	B mm	Z	P (inside blades)			K min.	K max.	α	β	Box	ORDER NO.
			3,2mm	2,4mm	1,6mm						
150	15,87	20	4 pcs.	1 pcs.	1 pcs.	6,35	22,23	-5° Neg.	FTG+ATB	3	<b>230.520.06</b>
200	15,87	24	4 pcs.	1 pcs.	1 pcs.	6,35	22,23	-5° Neg.	FTG+ATB	3	<b>230.524.08</b>
200	30	24	4 pcs.	1 pcs.	1 pcs.	6,35	22,23	-5° Neg.	FTG+ATB	3	<b>230.524.08M</b>

### Dado Pro set includes:

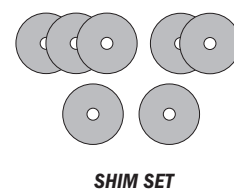
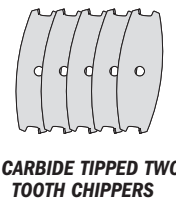
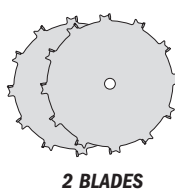

Shims set contains	
No.	Shim Width
3	0.1mm
2	0.2mm
1	0.3mm
1	0.5mm

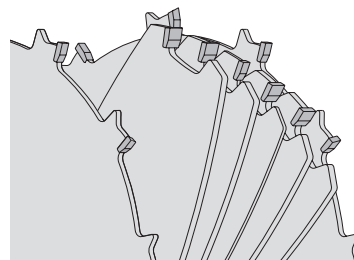
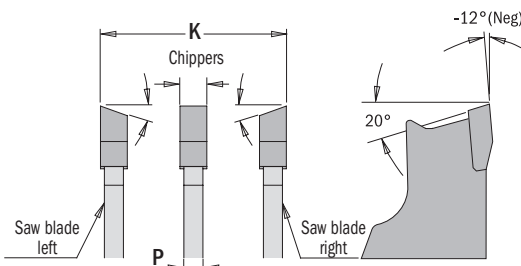
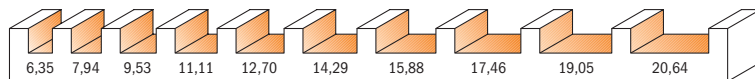

K mm	Number of required inside blades	
	1,6mm	3,2mm
6,35	0	0
7,94	1	0
9,53	0	1
11,11	1	1
12,70	0	2
14,29	1	2
15,88	0	3
17,46	1	3
19,05	0	4
20,64	1	4

D mm	B mm	Z	P (inside blades)		K min.	K max.	α	β	Box	ORDER NO.
			3,2mm	1,6mm						
200	15,87	12	4 pcs.	1 pcs.	6,35	20,64	-12° Neg.	FTG+ATB	5	<b>230.012.08</b>





## 240

**APPLICATION:** for grooving cuts or for rebating, chamfering, grooving and profiling as a set of tools.  
**MACHINES:** double-end tenoners and moulding machines.  
**MATERIAL:** soft and hardwood, wood-based panels, plastic.

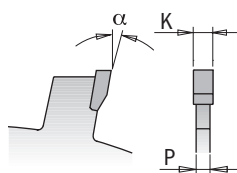
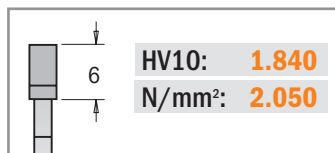

The new design allows multi-rip grooves using different kerf thickness.

D mm	B mm	Z	K mm	P mm	$\alpha$	$\beta$		ORDER NO.
150	30	12	2,0	1,4	15°	FLAT	1	240.020.06M
150	35	12	2,0	1,4	15°	FLAT	1	240.020.06R
150	30	12	3,0	2,0	15°	FLAT	1	240.030.06M
150	35	12	3,0	2,0	15°	FLAT	1	240.030.06R
150	30	12	4,0	3,0	15°	FLAT	1	240.040.06M
150	35	12	4,0	3,0	15°	FLAT	1	240.040.06R
150	30	12	5,0	3,0	15°	FLAT	1	240.050.06M
150	35	12	5,0	3,0	15°	FLAT	1	240.050.06R
150	30	12	6,0	3,0	15°	FLAT	1	240.060.06M
150	35	12	6,0	3,0	15°	FLAT	1	240.060.06R
180	30	18	3,0	2,0	15°	FLAT	1	240.030.07M
180	35	18	3,0	2,0	15°	FLAT	1	240.030.07R
180	30	18	4,0	3,0	15°	FLAT	1	240.040.07M
180	35	18	4,0	3,0	15°	FLAT	1	240.040.07R
180	30	18	5,0	3,0	15°	FLAT	1	240.050.07M
180	35	18	5,0	3,0	15°	FLAT	1	240.050.07R
180	30	18	6,0	3,0	15°	FLAT	1	240.060.07M
180	35	18	6,0	3,0	15°	FLAT	1	240.060.07R

## Grooving Saw Blades *Industrial Line*

**new**



## 240

**APPLICATION:** for grooving cuts and rebating.  
**MACHINES:** double-ended tenoners and moulding and CNC machines.  
**MATERIAL:** soft and hardwood and wood-based panels.

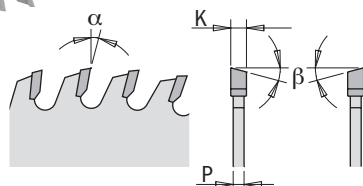

Suitable for these CNC chucks



183.410.30



183.420.30

D mm	B mm	PIN HOLE	Z	K mm	P mm	$\alpha$	$\beta$		ORDER NO.
150	30	4/6,5 - 12/48	36	3	2,2	5°	5°ATB	1	240.150.030M
150	30	4/6,5 - 12/48	36	4	3,0	5°	5°ATB	1	240.150.040M
150	30	4/6,5 - 12/48	36	5	3,0	5°	5°ATB	1	240.150.050M
150	30	4/6,5 - 12/48	36	6	3,0	5°	5°ATB	1	240.150.060M

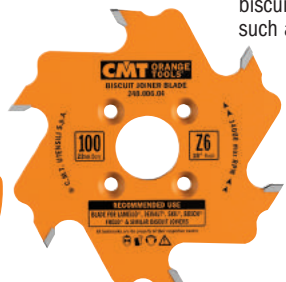

## 240-241

CMT's 100mm biscuit joiner saw blades featuring our trademark orange PTFE industrial coating make biscuit joints quickly and easily. These blades fit the most popular biscuit joint models on the market such as Lamello®, Dewalt®, Porter-Cable®, Skil®, Bosch®, Freud®.

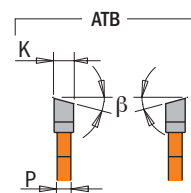
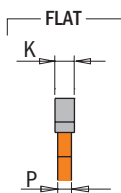
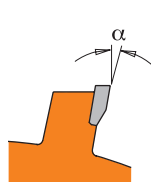

D mm	B mm	PIN HOLE	Z	K mm	P mm	α	β		ORDER NO.
100	22	4/4,5 - 9,5/36	6	3,96	3,0	18°	10° ATB	10	240.006.04
100	22	4/4,5 - 9,5/36	8	3,96	3,0	15°	10° ATB	10	240.008.04
100*	22	-	8	3,96	3,1-3,8	15°	FLAT	10	241.008.04

\* For Virutex® Machines

# Grooving Saw Blades



## 240

**APPLICATION:** P-System for connecting fittings. The connecting fitting is a preferred solution for open shelf units, large pieces of furniture and angled counters, and a popular choice as a general glueing aid for a variety of angles. Frequently used as a visually appealing and premium quality solid joint for high-end products.

- Knock down fitting for furniture, shelf units, fitted wardrobes, kitchen manufacturing etc.;
- Glueing aid for mitres and 45° angles;
- Connecting fittings for removable elements in trade booth construction and shopfitting projects;
- Great alternative to standard connecting fittings;
- Quick and easy prototype construction prior to launch of new furniture range;
- On-site adjustments and assembly.

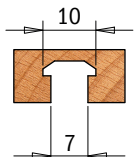
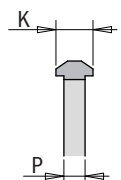
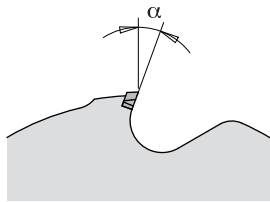

### MACHINES

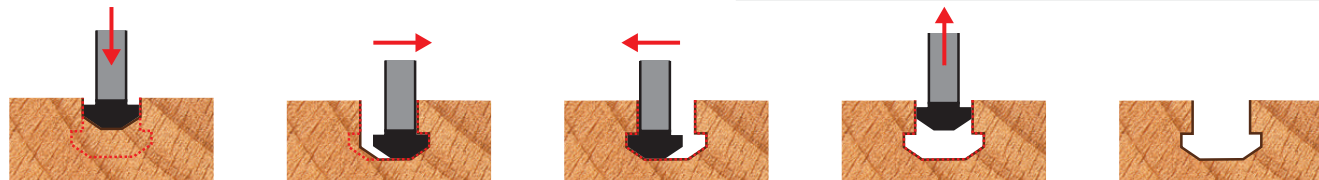
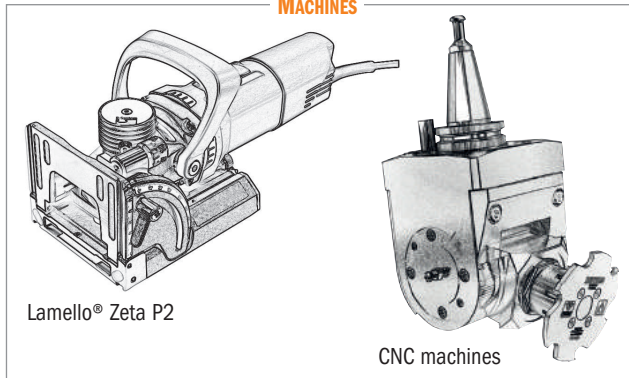

D mm	B mm	TEETH MATERIAL	MACHINE	PIN HOLE	Z	K mm	P mm	α	β		ORDER NO.
100,4	22	DP	Zeta P2	4/4,5 - 9,5/36	3	7	4	20°	TCG	1	240.601.04
100,4	30	DP	CNC	4/6,6 - 12/48	3	7	4	20°	TCG	1	240.601.04M
100,4	30	HW	CNC	4/6,6 - 12/48	6	7	4	20°	TCG	1	240.001.04*

\* PTFE Coated

new

## Circular Saw Blade for Patch Work & Repair



**240.004.04**

The CMT circular saw blade for patch work and repair is ideal for any type of repair work required on solid wood. Resin, knots and other unsightly wood defects are no longer a problem. Cut points using original patches remain practically invisible because wood and patch grains will match up perfectly. For use with Lamello® and other machines designed for patch work and repair.

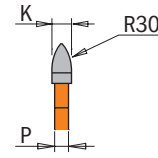
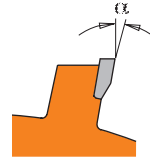

D mm	B mm	MACHINE	Z	K mm	P mm	α	β		ORDER NO.
100	22	Fit Lamello®	4	8,0	6,0	18°	R30	10	<b>240.004.04</b>

## Calibration & Sanding Disks



**299.11**

If you're looking for fast and easy saw alignment and balancing, the cut calibration and sanding disk is for you. First, mount your calibration and sanding disk in your table saw and line it up with a square for accuracy. Then, remove the calibration and sanding disk and mount your saw blade for true precise cuts. You can also use the calibration and sanding disk as a sander by simply attaching self-stick sandpaper and installing the disk in your table saw.



D mm	B mm	P mm		ORDER NO.
200	15,87	2,8	10	<b>299.111.00</b>
200	30	2,8	10	<b>299.111.00M</b>
250	15,87	2,8	10	<b>299.112.00</b>
250	30	2,8	10	<b>299.112.00M</b>

## Saw Blades Stabilizers



**299.10**

The CMT blade stabilizer virtually eliminates rim vibration to make cleaner, straighter cuts and extend the life of your CMT saw blade. It also helps lessen noise caused by vibration during cutting. **NOTE: for use on stationary saws only. Each order includes 2 stabilizers.**



DESCRIPTION	D mm	B mm	P mm		ORDER NO.
Stabilizer (2 pcs.) for Ø200mm	75	15,87	3,0	5	<b>299.101.00</b>
Stabilizer (2 pcs.) for Ø200mm	75	30	3,0	5	<b>299.101.00M</b>
Stabilizer (2 pcs.) for Ø250mm	125	15,87	3,0	5	<b>299.102.00</b>
Stabilizer (2 pcs.) for Ø250mm	125	30	3,0	5	<b>299.102.00M</b>
Stabilizer (2 pcs.) for Ø300mm	152	25,4	3,0	5	<b>299.103.00</b>
Stabilizer (2 pcs.) for Ø300mm	152	30	3,0	5	<b>299.103.00M</b>

## Reduction Rings for Saw Blades

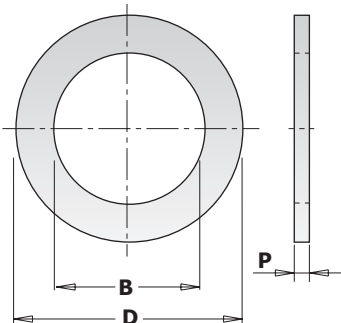

**299**

D mm	B mm	P mm		ORDER NO.	D mm	B mm	P mm		ORDER NO.
15,87	10	1,2	10	<b>299.218.00</b>	30	15	1,4	10	<b>299.240.00</b>
15,87	12,7	1,2	10	<b>299.217.00</b>	30	15,87	1,4	10	<b>299.211.00</b>
20	12,7	1,2	10	<b>299.221.00</b>	30	16	1,4	10	<b>299.223.00</b>
20	15,87	1,4	10	<b>299.243.00</b>	30	16	2,0	10	<b>299.226.00</b>
20	16	1,2	10	<b>299.222.00</b>	30	18	1,4	10	<b>299.232.00</b>
20	18	1,4	10	<b>299.236.00</b>	30	19,05	1,4	10	<b>299.241.00</b>
22,2	15	1,4	10	<b>299.237.00</b>	30	20	1,4	10	<b>299.224.00</b>
22,2	16	1,4	10	<b>299.242.00</b>	30	22	1,4	10	<b>299.231.00</b>
22,2	20	1,4	10	<b>299.238.00</b>	30	20	2,0	10	<b>299.227.00</b>
25,4	15,87	1,4	10	<b>299.216.00</b>	30	25	1,4	10	<b>299.225.00</b>
25,4	19,05	1,4	10	<b>299.213.00</b>	30	25	2,0	10	<b>299.228.00</b>
25,4	20	1,4	10	<b>299.214.00</b>	30	25,4	2,0	10	<b>299.212.00</b>
25,4	20	2,3	10	<b>299.220.00</b>	32	30	2,0	10	<b>299.229.00</b>
25,4	22	1,4	10	<b>299.215.00</b>	35	30	2,0	10	<b>299.230.00</b>
25,4	22,2	1,4	10	<b>299.239.00</b>	35	32	2,0	10	<b>299.233.00</b>
25,4	22,2	2,3	10	<b>299.219.00</b>					



D mm	B mm	MATERIALS/APPLICATION	Z	K mm	P mm	α	β	ORDER NO.	PAGE
70	20	Two-Sided Melamine	8+8	2,8-3,6		12°	FLAT	289.070.16H	23
80	20	Two-Sided Melamine	12	3,1-4,0	2,2	10°	CO+FTG	S288.080.12H	24
80	20	Two-Sided Melamine	10+10	2,8-3,6		12°	FLAT	289.080.20H	23
85	15	Wood	24	1,1	0,7	12°	15° ATB	K02403	36
85	15	Abrasive Materials	6	1,8	1,4	12°	TCG	236.085.06G	33
100	20	Two-Sided Melamine	20	3,1-4,0	2,5	5°	CO+5° ATB	288.100.20H	24
100	20	Two-Sided Melamine	10+10	2,8-3,6		12°	FLAT	289.100.20H	23
100	20	Two-Sided Melamine	10+10	2,8-3,6		11°	ATB	289.700.20H	23
100	22	Grooving	4	8	6	18°	R30	240.004.04	39
100	22	Grooving	6	3,96	3	18°	10° ATB	240.006.04	38
100	22	Grooving	8	3,96	3	15°	10° ATB	240.008.04	38
100	22	Grooving	8	3,96	3,1-3,8	15°	FLAT	241.008.04	38
100	22	Two-Sided Melamine	20	3,1-4,0	2,5	5°	CO+5° ATB	288.100.20K	24
100	22	Two-Sided Melamine	10+10	2,8-3,6		12°	FLAT	289.100.20K	23
100,4	22	Grooving	3	7	4	20°	TCG	240.601.04	39
100,4	30	Grooving	3	7	4	20°	TCG	240.601.04M	39
100,4	30	Grooving	6	7	4	20°	TCG	240.001.04	39
120	20	Wood & Plywood	18	1,8	1,2	15°	15° ATB	291.120.18H	34
120	20	Two-Sided Melamine	20	3,1-3,7		5°	CONICAL	238.120.20H	22
120	20	Two-Sided Melamine	24	3,1-4,0	2,5	5°	CO+5° ATB	288.120.24H	24
120	20	Two-Sided Melamine	24	3,4-4,2	2,5	5°	CO+5° ATB	288.120.24H1	24
120	20	Two-Sided Melamine	24	3,1-4,3	2,2	0°	CO+6° ATB	288.720.24H	24
120	20	Wood & Derivatives	36	1,8	1,2	10°	15° ATB	292.120.36H	35
120	20	Aluminium	36	1,8	1,2	-6° Neg.	TCG	296.120.36H	27
120	20	Wood & Derivatives	40	1,8	1,2	10°	15° ATB	292.120.40H	35
120	20	Two-Sided Melamine	12+12	2,8-3,6		12°	FLAT	289.120.24H	23
120	20	Two-Sided Melamine	12+12	2,8-3,6		11°	5° ATB	289.720.24H	23
120	22	Two-Sided Melamine	24	3,1-4,0	2,5	5°	CO+5° ATB	288.120.24K	24
120	22	Two-Sided Melamine	24	3,1-4,3	2,2	0°	CO+6° ATB	288.720.24K	24
120	22	Two-Sided Melamine	12+12	2,8-3,6		12°	FLAT	289.120.24K	23
120	22	Two-Sided Melamine	12+12	2,8-3,6		11°	5° ATB	289.720.24K	23
120	50	Two-Sided Melamine	12+12	2,8-3,6		12°	FLAT	289.120.24T	23
125	20	Two-Sided Melamine	20	3,1-3,7		5°	CONICAL	238.125.20H	22
125	20	Wood & Plywood	20	2,4	1,4	15°	15° ATB	291.125.20H	34
125	20	Two-Sided Melamine	24	3,1-4,0	2,5	5°	CO+5° ATB	288.125.24H	24
125	20	Two-Sided Melamine	24	3,4-4,2	2,5	5°	CO+5° ATB	288.125.24H1	24
125	20	Two-Sided Melamine	24	4,3-5,5	3,2	10°	CO+FTG	288.125.24H2	24
125	20	Two-Sided Melamine	24	3,1-4,3	2,2	0°	CO+6° ATB	288.725.24H	24
125	20	Wood & Derivatives	36	2,4	1,4	15°	15° ATB	292.125.36H	35
125	20	Two-Sided Melamine	12+12	2,8-3,6		12°	FLAT	289.125.24H	23
125	20	Two-Sided Melamine	12+12	2,8-3,6		11°	5° ATB	289.725.24H	23
125	22	Two-Sided Melamine	24	3,1-4,0	2,5	5°	CO+5° ATB	288.125.24K	24
125	22	Two-Sided Melamine	12+12	2,8-3,6		12°	FLAT	289.125.24K	23
125	22,23	Abrasive Materials	7	2,0	1,4	5°	TCG	236.125.07	33
125	45	Two-Sided Melamine	24	4,3-5,5	3,2	10°	CO+FTG	288.125.24Q	24
130	20	Wood & Plywood	20	2,4	1,4	15°	15° ATB	291.130.20H	34
130	20	Wood & Derivatives	36	2,4	1,4	15°	15° ATB	292.130.36H	35
136	20	Wood	18	1,5	1	15°	15° ATB	K13618H-X10	36
136	20 (+10)	Wood	18	1,5	1	20°	10° ATB + 8° Shear	271.136.18H	30, 32
136	20 (+10)	Wood & Plywood	36	1,5	1	18°	10° ATB + 8° Shear	272.136.36H	31
136,5	10	Metal & Steel	30	1,5	1,2	0°	8° FWF	226.030.05	28, 32
136,5	20	Metal & Steel	30	1,5	1,2	0°	8° FWF	226.030.05H	28, 32
140	16	Two-Sided Melamine	24	3,1-4,0	2,2	10°	CO+FTG	Y288.140.24E	24
140	20	Wood & Plywood	20	2,4	1,4	15°	15° ATB	291.140.20H	34
140	20	Wood & Derivatives	36	2,4	1,4	15°	15° ATB	292.140.36H	35
150	15,87	Grooving & Dado	20	6,35-22,23	3,2-2,4-1,6	-5° Neg.	FTG+ATB	230.520.06	37
150	16	Wood & Plywood	24	2,4	1,4	15°	15° ATB	291.150.24E	34
150	20	Wood	12	2,4	1,4	20°	10° ATB	290.150.12H	33
150	20	Wood & Plywood	24	2,4	1,4	15°	15° ATB	291.150.24H	34
150	20	Metal & Steel	32	1,6	1,2	0°	8° FWF	226.032.06H	28
150	20	Wood & Derivatives	40	2,4	1,4	15°	15° ATB	292.150.40H	35
150	30	Grooving	12	2	1,4	15°	FLAT	240.020.06M	38
150	30	Grooving	12	3	2	15°	FLAT	240.030.06M	38
150	30	Grooving	12	4	3	15°	FLAT	240.040.06M	38
150	30	Grooving	12	5	3	15°	FLAT	240.050.06M	38
150	30	Grooving	12	6	3	15°	FLAT	240.060.06M	38
150	30	Wood & Derivatives	48	3,2	2,2	5°	15° ATB	285.048.06M	13
150	30	Grooving	36	3	2,2	5°	5° ATB	240.150.030M	38
150	30	Grooving	36	4	3	5°	5° ATB	240.150.040M	38

# Saw Blade Index

D mm	B mm	MATERIALS/APPLICATION	Z	K mm	P mm	α	β	ORDER NO.	PAGE
150	30	Grooving	36	6	3	5°	5° ATB	240.150.060M	38
150	35	Grooving	12	2	1,4	15°	FLAT	240.020.06R	38
150	35	Grooving	12	3	2	15°	FLAT	240.030.06R	38
150	35	Grooving	12	4	3	15°	FLAT	240.040.06R	38
150	35	Grooving	12	5	3	15°	FLAT	240.050.06R	38
150	35	Grooving	12	6	3	15°	FLAT	240.060.06R	38
150	45	Two-Sided Melamine	36	4,3-5,5	3,2	10°	CO+FTG	288.150.36Q	24
150	20 (+16)	Wood	24	1,5	1	18°	10° ATB + 8° Shear	271.150.24H	30
150	20 (+16)	Wood & Plywood	40	1,5	1	16°	10° ATB + 8° Shear	272.150.40H	31
160	16	Wood	12	2,2	1,6	20°	10° ATB	290.160.12E	33
160	16	Wood & Plywood	24	2,2	1,6	15°	15° ATB	291.160.24E	34
160	16	Wood & Derivatives	40	2,2	1,6	10°	15° ATB	292.160.40E	35
160	20	Abrasive Materials	4	2,4	1,8	12°	TCG	236.160.04H	33
160	20	Abrasive Materials	10	2,4	1,8	5°	TCG	236.160.10H	33
160	20	Wood	12	2,2	1,6	20°	10° ATB	290.160.12H	33
160	20	Multi-Materials	20	2,2	1,6	10°	HR	235.160.20H	21
160	20	Aluminium	24	2,2	1,6	5°	TCG	284.160.24H	26
160	20	Wood & Plywood	24	2,2	1,6	15°	15° ATB	291.160.24H	34
160	20	Wood	24	2,2	1,4	15°	15° ATB	K16024H	36
160	20	Wood	24	2,2	1,4	15°	15° ATB	K16024H-X10	36
160	20	Wood & Derivatives	28	2,2	1,6	15°	10° ATB	285.160.28H	12
160	20	Metal & Steel	30	2	1,6	0°	8° FWF	226.030.06H	28
160	20	Two-Sided Melamine	34	2,6	1,8	10°	HDF	287.034.06H	18
160	20	Stainless Steel	40	1,8	1,4	10°	8° FWF	226.540.06H	28
160	20	Wood & Derivatives	40	2,2	1,6	10°	15° ATB	292.160.40H	35
160	20	Aluminium	40	2,2	1,6	-6° Neg.	TCG	296.160.40H	27
160	20	Wood	40	2,2	1,4	10°	15° ATB	K16040H	36
160	20	Wood	40	2,2	1,4	10°	15° ATB	K16040H-X10	36
160	20	Wood & Derivatives	48	2,2	1,6	5°	15° ATB	285.160.48H	13
160	20	Solid Surface	48	2,2	1,6	0°	MTCG	223.048.06H	29
160	20	Two-Sided Melamine	48	2,2	1,6	10°	TCG	281.160.48H	19
160	20	Two-Sided Melamine	56	2,2	1,6	-3° Neg.	TCG	281.161.56H	19
160	20	Wood & Derivatives	56	2,2	1,6	15°	15° ATB	292.160.56H	35
160	20	Aluminium	56	2,2	1,6	-6° Neg.	TCG	296.160.56H	27
160	30	Wood & Plywood	24	2,2	1,6	15°	15° ATB	291.160.24M	34
160	30	Wood & Derivatives	40	2,2	1,6	10°	15° ATB	292.160.40M	35
160	45	Two-Sided Melamine	36	4,3-5,5	3,2	10°	CO+FTG	288.160.36Q	24
160	55	Two-Sided Melamine	36	4,3-5,5	3,2	10°	CO+FTG	288.160.36Q	24
160	55	Two-Sided Melamine	36	4,7-6,0	3,5	10°	CO+FTG	Y288.160.36Q2	24
160	20 (+16)	Wood	24	1,8	1,2	18°	10° ATB + 8° Shear	271.160.24H	30
160	20 (+16)	Wood & Plywood	40	1,8	1,2	16°	10° ATB + 8° Shear	272.160.40H	31
160	20 (+16)	Aluminium & Melamine	48	1,8	1,2	-6° Neg.	TCG	276.160.48H	32
160	20 (+16)	Wood & Derivatives	56	1,8	1,2	12°	10° ATB + 8° Shear	273.160.56H	31
160	20 (Virutex)	Two-Sided Melamine	40	2,2	1,6	10°	TCG	281.160.40H	20
165	20	Wood & Plywood	24	2,2	1,6	15°	15° ATB	291.165.24H	34
165	20	Wood	24	1,7	1,1	15°	15° ATB	K16524H-X10	36
165	20	Metal & Steel	36	1,6	1,2	0°	8° FWF	226.036.06H	28
165	20	Wood & Derivatives	40	2,2	1,6	10°	15° ATB	292.165.40H	35
165	20	Aluminium	40	2,2	1,6	-6° Neg.	TCG	296.165.40H	27
165	20	Wood & Derivatives	56	2,2	1,6	15°	15° ATB	292.165.56H	35
165	20	Two-Sided Melamine	56	2,2	1,6	-3° Neg.	TCG	281.166.56H	19
165	20	Aluminium	56	2,2	1,6	-6° Neg.	TCG	296.165.56H	27
165	30	Wood	24	1,7	1,1	18°	10° ATB + 8° Shear	271.165.24M	30, 32
165	30	Wood & Plywood	24	2,6	1,6	15°	15° ATB	291.165.24M	34
165	30	Metal & Steel	36	1,6	1,2	0°	8° FWF	226.036.06M	28
165	30	Wood & Derivatives	40	2,6	1,6	10°	15° ATB	292.165.40M	35
165	15,87<>	Metal & Steel	36	1,6	1,2	0°	8° FWF	226.036.06	28, 32
165	20 (+15,87)	Abrasive Materials	4	1,8	1,4	12°	TCG	236.165.04H	33
165	20 (+15,87)	Abrasive Materials	10	1,8	1,4	5°	TCG	236.165.10H	33
165	20 (+15,87)	Wood	24	1,7	1,1	18°	10° ATB + 8° Shear	271.165.24H	30, 32
165	20 (+15,87)	Wood & Plywood	36	1,7	1,1	20°	10° ATB + 8° Shear	272.165.36H	30, 32
170	30	Wood & Plywood	24	2,6	1,6	20°	10° ATB	291.170.24M	34
170	30	Wood & Derivatives	40	2,6	1,6	15°	15° ATB	292.170.40M	35
180	20	Abrasive Materials	4	2,4	1,8	12°	TCG	236.180.04H	33
180	20	Wood & Plywood	24	2,6	1,6	20°	10° ATB	291.180.24H	34
180	20	Two-Sided Melamine	36	4,3-5,5	3,2	10°	CO+FTG	Y288.180.36H	24
180	20	Wood & Derivatives	40	2,6	1,6	15°	15° ATB	292.180.40H	35
180	20	Aluminium	40	2,8	2,2	-6° Neg.	TCG	296.180.40H	27
180	30	Wood	12	2,6	1,6	20°	10° ATB	290.180.12M	33

D mm	B mm	MATERIALS/APPLICATION	Z	K mm	P mm	α	β	ORDER NO.	PAGE
180	30	Grooving	18	3	2	15°	FLAT	240.030.07M	38
180	30	Grooving	18	4	3	15°	FLAT	240.040.07M	38
180	30	Grooving	18	5	3	15°	FLAT	240.050.07M	38
180	30	Grooving	18	6	3	15°	FLAT	240.060.07M	38
180	30	Wood & Plywood	24	2,6	1,6	20°	10° ATB	291.180.24M	34
180	30	Two-Sided Melamine	36	4,4-5,3	3,2	10°	CO+FTG	288.180.36M	24
180	30	Wood & Derivatives	40	2,6	1,6	15°	15° ATB	292.180.40M	35
180	30	Wood & Derivatives	56	3,2	2,2	5°	15° ATB	285.056.07M	13
180	35	Grooving	18	3	2	15°	FLAT	240.030.07R	38
180	35	Grooving	18	4	3	15°	FLAT	240.040.07R	38
180	35	Grooving	18	5	3	15°	FLAT	240.050.07R	38
180	35	Grooving	18	6	3	15°	FLAT	240.060.07R	38
180	40	Multi-Rip	21+3	2,5	1,8	18°	FLAT	280.021.07S	10
180	45	Two-Sided Melamine	36	4,8-5,6	3,5	10°	CO+FTG	288.180.36Q	24
180	45	Two-Sided Melamine	36	4,3-5,5	3,2	8°	CO+5° ATB	288.180.36Q2	24
180	50	Two-Sided Melamine	44	4,3-5,5	3,2	10°	CO+FTG	288.180.44T	24
180	55	Two-Sided Melamine	36	5,0-6,2	3,5	10°	CO+FTG	288.180.36O	24
184	16	Wood & Plywood	24	2,6	1,6	20°	10° ATB	291.184.24E	34
184	16	Wood & Derivatives	40	2,6	1,6	15°	15° ATB	292.184.40E	35
184	30	Wood	24	1,7	1,1	20°	10° ATB + 8° Shear	271.184.24M	30
184	30	Wood & Plywood	24	2,6	1,6	20°	10° ATB	291.184.24M	34
184	30	Wood & Plywood	40	1,7	1,1	18°	10° ATB + 8° Shear	272.184.40M	31
184	30	Wood & Derivatives	40	2,6	1,6	15°	15° ATB	292.184.40M	35
184	15,87<>	Metal & Steel	48	2	1,6	0°	8° FWF	226.048.07	28
184	15,87<>	Stainless Steel	48	2	1,6	10°	8° FWF	226.548.07	28
184	20 (+16+15,87)	Wood	24	1,7	1,1	20°	10° ATB + 8° Shear	271.184.24H	30, 32
184	20 (+16+15,87)	Wood & Plywood	40	1,7	1,1	18°	10° ATB + 8° Shear	272.184.40H	30, 32
184	20 (+16+15,87)	Aluminium & Melamine	48	1,8	1,2	-6° Neg.	TCG	276.184.48H	32
190	16	Wood	12	2,6	1,6	20°	10° ATB	290.190.12E	33
190	16	Wood & Plywood	24	2,6	1,6	20°	10° ATB	291.190.24E	34
190	16	Wood & Derivatives	40	2,6	1,6	15°	15° ATB	292.190.40E	35
190	20	Wood	12	2,6	1,6	20°	10° ATB	290.190.12H	33
190	20	Wood & Plywood	24	2,6	1,6	20°	10° ATB	291.190.24H	34
190	20	Wood & Derivatives	40	2,6	1,6	15°	15° ATB	292.190.40H	35
190	30	Abrasive Materials	4	2,4	1,8	12°	TCG	236.190.04M	33
190	30	Abrasive Materials	12	2,4	1,8	12°	TCG	236.190.12M	33
190	30	Wood	12	2,6	1,6	20°	10° ATB	290.190.12M	33
190	30	Multi-Materials	24	2,5	2	10°	HR	235.190.24M	21
190	30	Wood & Plywood	24	2,6	1,6	20°	10° ATB	291.190.24M	34
190	30	Wood	24	2,2	1,4	20°	10° ATB	K19024M	36
190	30	Wood	24	2,2	1,4	20°	10° ATB	K19024M-X10	36
190	30	Aluminium	30	2,6	2,2	5°	TCG	284.190.30M	26
190	30	Metal & Steel	40	2	1,6	0°	8° FWF	226.040.07M	28
190	30	Wood & Derivatives	40	2,6	1,6	15°	15° ATB	292.190.40M	35
190	30	Aluminium	40	2,8	2,2	-6° Neg.	TCG	296.190.40M	27
190	30	Wood	40	2,2	1,4	15°	10° ATB	K19040M	36
190	30	Stainless Steel	48	1,8	1,4	10°	8° FWF	226.548.07M	28
190	30	Wood & Derivatives	64	2,6	1,6	15°	15° ATB	292.190.64M	35
190	30	Aluminium	64	2,8	2,2	-6° Neg.	TCG	296.190.64M	27
190	20 (Festool® FF)	Wood & Plywood	32	2,6	1,8	10°	10° ATB	291.190.32FF	34
190	20 (Festool® FF)	Wood & Derivatives	48	2,4	1,8	10°	15° ATB	292.190.48FF	35
190	20 (Festool® FF)	Two-Sided Melamine	54	2,6	1,8	4°	TCG	281.190.54FF	19
190	20 (Festool® FF)	Aluminium	64	2,8	2,2	-6° Neg.	TCG	296.190.64FF	27
190	20 (+20+16)	Aluminium & Melamine	64	1,8	1,2	-6° Neg.	TCG	276.190.64M	32
190	30 (+20+16)	Wood	24	1,7	1,1	20°	10° ATB + 8° Shear	271.190.24M	30
190	30 (+20+16)	Wood & Plywood	42	1,7	1,1	18°	10° ATB + 8° Shear	272.190.42M	31
190	30 (+20+16)	Wood & Derivatives	64	1,7	1,1	15°	10° ATB + 8° Shear	273.190.64M	31
200	15,87	Grooving & Dado	12	3,2-1,6	6,35-20,64	-12° Neg.	FTG+ATB	230.012.08	37
200	15,87	Grooving & Dado	24	6,35-22,23	3,2-2,4-1,6	-5° Neg.	FTG+ATB	230.524.08	37
200	20	Two-Sided Melamine	36	4,4-5,3	3,2	10°	CO+FTG	288.200.36H	24
200	30	Grooving & Dado	24	6,35-22,23	3,2-2,4-1,6	-5° Neg.	FTG+ATB	230.524.08M	37
200	30	Wood	24	2,8	1,8	20°	10° ATB	290.200.24M	33
200	30	Wood	36	1,8	1,2	15°	10° ATB + 8° Shear	271.200.36M	30
200	30	Wood & Derivatives	36	3,2	2,2	15°	10° ATB	285.036.08M	12
200	30	Wood & Plywood	36	2,8	1,8	15°	15° ATB	291.200.36M	34
200	30	Wood & Plywood	48	1,8	1,2	15°	10° ATB + 8° Shear	272.200.48M	31
200	30	Wood & Derivatives	48	3,2	2,2	15°	15° ATB	285.048.08M	12
200	30	Wood & Derivatives	48	2,8	1,8	15°	15° ATB	292.200.48M	35
200	30	Aluminium	48	2,8	2,2	-6° Neg.	TCG	296.200.48M	27



D mm	B mm	MATERIALS/APPLICATION	Z	K mm	P mm	α	β	ORDER NO.	PAGE
200	30	Two-Sided Melamine	64	3,2	2,2	10°	TCG	281.064.08M	19
200	30	Wood & Derivatives	64	3,2	2,2	5°	15° ATB	285.064.08M	13
200	40	Multi-Rip	21+3	2,5	1,8	18°	FLAT	280.021.08S	10
200	45	Two-Sided Melamine	36	4,7-6,0	3,5	10°	CO+FTG	288.200.36Q	24
200	45	Two-Sided Melamine	36	4,3-5,5	3,2	10°	CO+FTG	Y288.200.36Q2	24
200	65	Two-Sided Melamine	36	4,4-5,3	3,2	10°	CO+FTG	288.200.36J	24
210	25	Wood	24	2,8	1,8	20°	10° ATB	290.210.24L	33
210	25	Wood & Plywood	36	2,8	1,8	15°	15° ATB	291.210.36L	34
210	25	Wood & Derivatives	48	2,8	1,8	15°	15° ATB	292.210.48L	35
210	30	Abrasive Materials	12	2,4	1,8	12°	TCG	236.210.12M	33
210	30	Wood	24	2,8	1,8	20°	10° ATB	290.210.24M	33
210	30	Wood & Plywood	36	2,8	1,8	15°	15° ATB	291.210.36M	34
210	30	Metal & Steel	48	2,2	1,8	0°	8° FWF	226.048.08M	28
210	30	Wood & Derivatives	48	2,8	1,8	15°	15° ATB	292.210.48M	35
210	30	Aluminium	48	2,8	2,2	-6° Neg.	TCG	296.210.48M	27
210	30	Wood & Derivatives	64	2,8	1,8	15°	15° ATB	292.210.64M	35
210	30	Aluminium	64	2,8	2,2	-6° Neg.	TCG	296.210.64M	27
210	15,87<	Metal & Steel	48	2,2	1,8	0°	8° FWF	226.048.08	28
210	30 (+25)	Wood	24	1,8	1,2	20°	10° ATB + 8° Shear	271.210.24M	30
210	30 (+25)	Wood	36	1,8	1,2	15°	10° ATB + 8° Shear	271.210.36M	30
210	30 (+25)	Wood & Plywood	48	1,8	1,2	15°	10° ATB + 8° Shear	272.210.48M	31
210	30 (+25)	Aluminium & Melamine	64	1,8	1,2	-6° Neg.	TCG	276.210.64M	32
215	50	Two-Sided Melamine	42	4,3-5,5	3,2	10°	CO+FTG	288.215.42T	24
216	30	Abrasive Materials	14	2,4	1,8	12°	TCG	236.216.14M	33
216	30	Wood	24	2,8	1,8	-5° Neg.	15° ATB	290.216.24M	33
216	30	Wood	24	2,4	1,6	-5° Neg.	15° ATB	K21624M	36
216	30	Wood	24	2,4	1,6	-5° Neg.	15° ATB	K21624M-X10	36
216	30	Multi-Materials	30	2,5	2	10°	HR	235.216.30M	21
216	30	Wood	36	1,8	1,2	-5° Neg.	10° ATB + 8° Shear	271.216.36M	30
216	30	Aluminium	40	2,6	2,2	5°	TCG	284.216.40M	26
216	30	Metal & Steel	48	2,2	1,8	0°	8° FWF	226.047.09M	28
216	30	Wood & Plywood	48	1,8	1,2	-5° Neg.	10° ATB + 8° Shear	272.216.48M	31
216	30	Wood & Plywood	48	2,8	1,8	-5° Neg.	15° ATB	291.216.48M	34
216	30	Wood	48	2,4	1,6	-5° Neg.	15° ATB	K21648M	36
216	30	Wood	48	2,4	1,6	-5° Neg.	15° ATB	K21648M-X10	36
216	30	Stainless Steel	56	1,8	1,4	10°	8° FWF	226.556.09M	28
216	30	Wood & Derivatives	64	1,8	1,2	-5° Neg.	10° ATB + 8° Shear	273.216.64M	31
216	30	Aluminium & Melamine	64	2,2	1,6	-6° Neg.	TCG	276.216.64M	32
216	30	Wood & Derivatives	64	2,8	1,8	-5° Neg.	15° ATB	292.216.64M	35
216	30	Aluminium	64	2,8	2,2	-6° Neg.	TCG	297.064.09M	27
216	30	Wood & Derivatives	80	2,8	1,8	-5° Neg.	15° ATB	292.216.80M	35
216	30	Aluminium	80	2,8	2,2	-6° Neg.	TCG	297.080.09M	27
220	30	Wood	24	2,8	1,8	20°	10° ATB	290.220.24M	33
220	30	Wood & Plywood	36	2,8	1,8	15°	15° ATB	291.220.36M	34
220	30	Two-Sided Melamine	42	3,2	2,2	10°	HDF	287.042.09M	18
220	30	Two-Sided Melamine	42	3,2	2,2	-6° Neg.	HDF	287.043.09M	17
220	30	Wood & Derivatives	48	2,8	1,8	15°	15° ATB	292.220.48M	35
220	30	Two-Sided Melamine	63	3,2	2,2	-3° Neg.	FFT	281.063.09M	19
220	30	Two-Sided Melamine	64	3,2	2,2	10°	TCG	281.064.09M	19
220	30	Two-Sided Melamine	64	3,2	2,2	-5° Neg.	40° ATB	283.064.09M	15
225	30	Wood & Plywood	36	2,8	1,8	20°	15° ATB	291.225.36M	34
225	30	Wood & Derivatives	48	2,8	1,8	10°	15° ATB	292.225.48M	35
225	30	Two-Sided Melamine	64	2,6	1,8	4°	TCG	281.225.64M	19
225	30	Aluminium	64	2,8	2,2	-6° Neg.	TCG	296.225.64M	27
230	30	Abrasive Materials	4	2,4	1,8	12°	TCG	236.230.04M	33
230	30	Wood	24	2,8	1,8	20°	10° ATB	290.230.24M	33
230	30	Wood & Plywood	36	2,8	1,8	15°	15° ATB	291.230.36M	34
230	30	Wood & Derivatives	48	2,8	1,8	15°	15° ATB	292.230.48M	35
230	30	Aluminium	48	2,8	2,2	-6° Neg.	TCG	296.230.48M	27
230	30	Wood & Derivatives	64	2,8	1,8	15°	15° ATB	292.230.64M	35
235	25	Wood	24	2,8	1,8	20°	10° ATB	290.235.24L	33
235	25	Wood & Plywood	36	2,8	1,8	15°	15° ATB	291.235.36L	34
235	25	Wood & Derivatives	48	2,8	1,8	15°	15° ATB	292.235.48L	35
235	30	Wood	24	2,8	1,8	20°	10° ATB	290.235.24M	33
235	30	Wood & Plywood	36	2,8	1,8	15°	15° ATB	291.235.36M	34
235	30	Metal & Steel	48	2,2	1,8	0°	8° FWF	226.048.09M	28
235	30	Wood & Derivatives	48	2,8	1,8	15°	15° ATB	292.235.48M	35
235	30	Aluminium	48	2,8	2,2	-6° Neg.	TCG	296.235.48M	27
235	30 (+25)	Wood	36	2,4	1,6	18°	10° ATB + 8° Shear	271.235.36M	30

D mm	B mm	MATERIALS/APPLICATION	Z	K mm	P mm	α	β	ORDER NO.	PAGE
235	30 (+25)	Wood & Plywood	48	2,4	1,6	18°	10° ATB + 8° Shear	272.235.48M	31
240	30	Wood	24	2,8	1,8	20°	10° ATB	290.240.24M	33
240	30	Wood & Plywood	36	2,8	1,8	15°	15° ATB	291.240.36M	34
240	30	Wood & Derivatives	48	2,8	1,8	15°	15° ATB	292.240.48M	35
250	20	Garden	20	2,2	1,4	15°	10° ATB	298.250.20H	32
250	20	Wood & Derivatives	40	3,2	2,2	15°	10° ATB	285.040.10H	12
250	25,4	Garden	20	2,2	1,4	15°	10° ATB	298.250.20	32
250	30	Abrasive Materials	16	2,4	1,8	12°	TCG	236.250.16M	33
250	30	Construction Materials	16	2,8	1,8	15°	5° ATB	286.016.10M	11
250	30	Wood	24	2,4	1,6	20°	10° ATB + 8° Shear	271.250.24M	30
250	30	Wood	24	2,8	1,8	20°	10° ATB	290.250.24M	11, 33
250	30	Wood	24	2,6	1,8	20°	10° ATB	K25024M	36
250	30	Multi-Materials	36	2,5	2	10°	HR	235.250.36M	21
250	30	Wood & Derivatives	40	3,2	2,2	15°	10° ATB	285.040.10M	15
250	30	Wood & Derivatives	40	3,2	2,2	15°	10° ATB	285.640.10M	14
250	30	Wood	40	2,6	1,8	15°	10° ATB	K25040M	36
250	30	Wood	40	2,6	1,8	15°	10° ATB	K25040M-X05	36
250	30	Wood	42	2,4	1,6	18°	10° ATB + 8° Shear	271.250.42M	30
250	30	Two-Sided Melamine	48	3,2	2,2	10°	45° TCG	237.048.10M	22
250	30	Wood & Derivatives	48	3,2	2,2	15°	10° ATB	285.048.10M	12
250	30	Two-Sided Melamine	48	3,2	2,2	10°	HDF	287.048.10M	17
250	30	Two-Sided Melamine	48	3,2	2,2	-6° Neg.	HDF	287.049.10M	16
250	30	Two-Sided Melamine	48	3,2	2,2	10°	HDF	287.648.10M	17
250	30	Wood & Plywood	60	2,4	1,6	15°	10° ATB + 8° Shear	272.250.60M	31
250	30	Two-Sided Melamine	60	3,2	2,2	10°	TCG	281.060.10M	20, 25
250	30	Two-Sided Melamine	60	3,2	2,2	-3° Neg.	FFT	281.061.10M	19
250	30	Wood & Derivatives	60	3,2	2,2	10°	15° ATB	285.060.10M	12
250	30	Wood & Derivatives	60	3,2	2,2	10°	15° ATB	285.660.10M	14
250	30	Solid Surface	72	3,2	2,5	0°	MTCG	223.072.10M	29
250	30	Stainless Steel	72	2,2	1,8	10°	8° FWF	226.572.10M	28
250	30	Two-Sided Melamine	78	3,2	2,2	10°	FFT	295.078.10M	18
250	30	Aluminium & Melamine	80	2,6	1,8	-6° Neg.	TCG	276.250.80M	32
250	30	PVC, Plexiglass	80	2,8	2,2	-3° Neg.	MATB	222.080.10M	29
250	30	Wood & Derivatives	80	2,4	1,6	12°	10° ATB + 8° Shear	273.250.80M	31
250	30	Multi-Materials	80	3,2	2,2	15°	1FTG+4ATB	274.080.10M	16
250	30	Two-Sided Melamine	80	3,2	2,2	10°	TCG	281.080.10M	20, 25
250	30	Two-Sided Melamine	80	3,2	2,2	5°	TCG	281.680.10M	18
250	30	Two-Sided Melamine	80	3,2	2,2	-2° Neg.	40° ATB	283.080.10M	15
250	30	Two-Sided Melamine	80	3,2	2,2	-2° Neg.	38° ATB	283.680.10M	15
250	30	Wood & Derivatives	80	3,2	2,2	5°	15° ATB	285.080.10M	13
250	30	Wood & Derivatives	80	3	2,5	10°	20° ATB	285.580.10M	13
250	30	Wood & Derivatives	80	3,2	2,2	5°	15° ATB	285.680.10M	14
250	30	Aluminium	80	3,2	2,5	-6° Neg.	TCG	297.080.10M	27
250	30	Two-Sided Melamine	80	3,2	2,2	-3° Neg.	TCG	281.681.10M	19
250	30	Multi-Rip	20+4	3,2	2,2	18°	10° ATB	279.020.10M	9
250	32	Aluminium	80	3,2	2,5	5°	TCG	284.080.10P	26
250	32	Aluminium	80	3,2	2,5	-6° Neg.	TCG	297.080.10P	27
250	35	Wood & Derivatives	40	3,2	2,2	15°	10° ATB	285.040.10R	12
250	35	Wood & Derivatives	60	3,2	2,2	10°	15° ATB	285.060.10R	12
250	35	Wood & Derivatives	80	3,2	2,2	5°	15° ATB	285.080.10R	13
250	70	Multi-Rip	20+4	3,2	2,2	18°	10° ATB	279.020.10V	9
250	70	Multi-Rip	20+4	2,7	1,8	18°	10° ATB	280.020.10V	10
250	80	Multi-Rip	20+4	3,2	2,2	18°	10° ATB	279.020.10W	9
250	80	Multi-Rip	20+4	2,7	1,8	18°	10° ATB	280.020.10W	10
254	15,87	Metal & Steel	48	2,2	1,8	0°	8° FWF	226.048.10	28
254	15,87	Metal & Steel	60	2,2	1,8	0°	8° FWF	226.060.10	28
254	15,87	Stainless Steel	72	2,2	1,8	10°	8° FWF	226.572.10	28
254	30	Wood & Plywood	48	2,4	1,8	-5° Neg.	15° ATB	294.048.10M	12
254	30	Metal & Steel	60	2,2	1,8	0°	8° FWF	226.060.10M	28
254	30	Wood & Plywood	60	2,4	1,8	-5° Neg.	15° ATB	294.060.10M	12
254	30	Aluminium	80	3,2	2,5	-5° Neg.	TCG	297.081.10M	27
260	30	Wood	28	2,8	1,8	20°	10° ATB	290.260.28M	11, 33
260	30	Wood & Derivatives	48	2,8	1,8	15°	10° ATB	285.048.11M	12
260	30	Wood & Derivatives	60	2,8	1,8	10°	15° ATB	285.060.11M	12
260	30	Wood & Plywood	60	2,5	1,8	-5° Neg.	15° ATB	294.060.11M	12
260	30	Two-Sided Melamine	64	2,5	1,8	-3° Neg.	TCG	281.065.11M	19
260	30	Wood & Derivatives	80	2,5	1,8	-5° Neg.	15° ATB	294.080.11M	13
260	30	Aluminium	80	2,8	2,2	-6° Neg.	TCG	297.080.11M	27
270	30	Wood	28	2,8	1,8	20°	10° ATB	290.270.28M	11, 33

D mm	B mm	MATERIALS/APPLICATION	Z	K mm	P mm	α	β	ORDER NO.	PAGE
270	30	Wood & Plywood	42	2,8	1,8	15°	15° ATB	291.270.42M	12, 34
275	20	Wood & Derivatives	42	3,2	2,2	15°	10° ATB	285.042.11H	12
280	30	Wood & Plywood	64	2,8	1,8	10°	15° ATB	295.064.11M	12
280	30	Aluminium	64	3,2	2,5	-6° Neg.	TCG	297.064.11M	27
300	20	Wood & Derivatives	48	3,2	2,2	15°	10° ATB	285.048.12H	12
300	30	Abrasive Materials	20	2,4	1,8	12°	TCG	236.300.20M	33
300	30	Construction Materials	20	2,8	1,8	15°	5° ATB	286.020.12M	11
300	30	Wood	24	2,6	1,8	22°	10° ATB + 8° Shear	271.300.24M	30
300	30	Wood	24	3,2	2,2	20°	10° ATB	293.024.12M	11
300	30	Multi-Rip	28	3,2	2,2	18°	10° ATB	278.028.12M	9
300	30	Wood & Derivatives	36	3,2	2,2	15°	10° ATB	285.036.12M	12
300	30	Multi-Materials	44	2,5	2	10°	HR	235.300.44M	21
300	30	Wood	48	2,6	1,8	18°	10° ATB + 8° Shear	271.300.48M	30
300	30	Wood & Derivatives	48	3,2	2,2	15°	10° ATB	285.048.12M	12
300	30	Wood & Derivatives	48	3,2	2,2	15°	10° ATB	285.648.12M	14
300	30	Construction Materials	48	3,2	2,2	15°	10° ATB	286.048.12M	11
300	30	Two-Sided Melamine	60	3,2	2,2	10°	45° TCG	237.060.12M	22
300	30	Two-Sided Melamine	60	4,4	3,2	16°	TCG	282.060.12M	25
300	30	Wood & Derivatives	60	3,2	2,2	15°	10° ATB	285.060.12M	12
300	30	Wood & Plywood	72	2,6	1,8	15°	10° ATB + 8° Shear	272.300.72M	31
300	30	Two-Sided Melamine	72	3,2	2,2	10°	TCG	281.072.12M	19, 25
300	30	Two-Sided Melamine	72	3,2	2,2	-3° Neg.	FFT	281.073.12M	19
300	30	Two-Sided Melamine	72	3,2	2,2	10°	TCG	281.672.12M	18
300	30	Wood & Derivatives	72	3,2	2,2	10°	15° ATB	285.072.12M	12
300	30	Wood & Derivatives	72	3,2	2,2	10°	15° ATB	285.672.12M	14
300	30	Stainless Steel	80	2,2	1,8	10°	8° FWF	226.580.12M	28
300	30	Solid Surface	84	3,2	2,5	0°	MTCG	223.084.12M	29
300	30	Aluminium & Melamine	96	2,8	2,0	-6° Neg.	TCG	276.300.96M	32
300	30	PVC, Plexiglass	96	2,8	2,2	-3° Neg.	MATB	222.096.12M	29
300	30	Two-Sided Melamine	96	3,2	2,2	15°	45° TCG	237.096.12M	22
300	30	Wood & Derivatives	96	2,6	1,8	12°	10° ATB + 8° Shear	273.300.96M	31
300	30	Two-Sided Melamine	96	3,2	2,2	10°	TCG	281.096.12M	19, 25
300	30	Two-Sided Melamine	96	3,2	2,2	-3° Neg.	TCG	281.697.12M	19
300	30	Two-Sided Melamine	96	3,2	2,2	5°	TCG	281.696.12M	18
300	30	Two-Sided Melamine	96	3,2	2,2	2°	40° ATB	283.096.12M	15
300	30	Two-Sided Melamine	96	3,2	2,2	2°	38° ATB	283.696.12M	15
300	30	Wood & Derivatives	96	3,2	2,2	5°	15° ATB	285.096.12M	13
300	30	Wood & Derivatives	96	3	2,5	10°	20° ATB	285.596.12M	13
300	30	Wood & Derivatives	96	3,2	2,2	5°	15° ATB	285.696.12M	14
300	30	Two-Sided Melamine	96	3,2	2,2	10°	FFT	295.096.12M	18
300	30	Aluminium	96	3,2	2,5	-6° Neg.	TCG	297.096.12M	27
300	30	Multi-Materials	100	3,2	2,2	15°	1FTG+4ATB	274.100.12M	16
300	30	Multi-Rip	24+4	3,2	2,2	18°	10° ATB	279.024.12M	9
300	30	Multi-Rip	24+4	4	2,8	18°	10° ATB	277.024.12M	10
300	32	Aluminium	96	3,2	2,5	5°	TCG	284.096.12P	26
300	32	Aluminium	96	3,2	2,5	-6° Neg.	TCG	297.096.12P	27
300	35	Wood	24	3,2	2,2	20°	10° ATB	293.024.12R	11
300	35	Wood & Derivatives	48	3,2	2,2	15°	10° ATB	285.048.12R	12
300	35	Wood & Derivatives	72	3,2	2,2	10°	15° ATB	285.072.12R	12
300	35	Wood & Derivatives	96	3,2	2,2	5°	15° ATB	285.096.12R	13
300	50	Two-Sided Melamine	48	4,3-5,5	3,2	10°	CO+FTG	288.300.48T	24
300	60	Multi-Rip	24+4	3,2	2,2	18°	10° ATB	279.024.12U	9
300	65	Two-Sided Melamine	72	4,3-5,5	3,2	10°	CO+FTG	288.300.72J	24
300	70	Multi-Rip	28	3,2	2,2	18°	10° ATB	278.028.12V	9
300	70	Multi-Rip	24+4	3,2	2,2	18°	10° ATB	279.024.12V	9
300	70	Multi-Rip	24+4	2,7	1,8	18°	10° ATB	280.024.12V	10
300	70	Multi-Rip	24+4	4	2,8	18°	10° ATB	277.024.12V	10
300	75	Two-Sided Melamine	60	4,4	3,2	16°	TCG	282.060.12X	25
300	80	Two-Sided Melamine	60	4,4	3,2	16°	TCG	282.060.12W	25
300	80	Multi-Rip	24+4	3,2	2,2	18°	10° ATB	279.024.12W	9
300	80	Multi-Rip	24+4	2,7	1,8	18°	10° ATB	280.024.12W	10
300	80	Multi-Rip	24+4	4	2,8	18°	10° ATB	277.024.12W	10
303	30	Two-Sided Melamine	60	3,2	2,2	10°	HDF	287.060.12M	17
303	30	Two-Sided Melamine	60	3,2	2,2	-6° Neg.	HDF	287.061.12M	16
303	30	Two-Sided Melamine	60	3,2	2,2	10°	HDF	287.660.12M	17
305	25,4	Metal & Steel	60	2,2	1,8	0°	8° FWF	226.060.12	28
305	25,4	Metal & Steel	80	2,2	1,8	0°	8° FWF	226.080.12	28
305	25,4	Stainless Steel	80	2,2	1,8	10°	8° FWF	226.580.12	28
305	30	Wood	28	2,8	1,8	20°	10° ATB	293.028.22M	11



D mm	B mm	MATERIALS/APPLICATION	Z	K mm	P mm	α	β	ORDER NO.	PAGE
305	30	Wood	40	2,8	2	-5° Neg.	10° ATB	K30540M	36
305	30	Wood & Plywood	54	2,8	1,8	-5° Neg.	15° ATB	294.054.22M	12
305	30	Wood	60	2,8	2	-5° Neg.	10° ATB	K30560M	36
305	30	Wood & Derivatives	72	3,2	2,2	10°	15° ATB	285.072.22M	13
305	30	Wood & Plywood	72	3,2	2,2	-5° Neg.	15° ATB	294.072.22M	13
305	30	Metal & Steel	80	2,2	1,8	0°	8° FWF	226.080.12M	28
305	30	Aluminium & Melamine	96	2,8	2,0	-6° Neg.	TCG	276.305.96M	32
305	30	Aluminium	96	3,2	2,5	-6° Neg.	TCG	297.096.13M	27
315	30	Construction Materials	24	3,2	2,2	15°	5° ATB	286.024.13M	11
315	30	Wood	28	3,2	2,2	20°	10° ATB	293.028.12M	11
315	30	Wood	36	3,2	2,2	15°	5° ATB	285.036.13M	11
315	30	Wood & Plywood	54	3,2	2,2	15°	10° ATB	294.054.12M	12
315	30	Wood & Derivatives	72	3,2	2,2	15°	10° ATB	285.072.13M	13
315	30	Aluminium	96	3,2	2,5	-6° Neg.	TCG	297.096.23M	27
320	65	Two-Sided Melamine	60	4,4	3,2	16°	TCG	Y282.060.13J	25
320	65	Two-Sided Melamine	72	4,4	3,2	16°	TCG	282.072.13J	25
330	30	Aluminium	96	3,2	2,5	-6° Neg.	TCG	297.096.33M	27
330	32	Aluminium	96	3,2	2,5	-6° Neg.	TCG	297.096.33P	27
350	30	Construction Materials	24	3,2	2,2	15°	5° ATB	286.024.14M	11
350	30	Wood	28	3,5	2,5	20°	10° ATB	293.028.14M	11
350	30	Multi-Rip	36	3,5	2,5	18°	10° ATB	278.036.14M	9
350	30	Two-Sided Melamine	54	4,4	3,2	16°	TCG	282.054.14M	25
350	30	Wood & Derivatives	54	3,5	2,5	15°	10° ATB	285.054.14M	12
350	30	Wood & Derivatives	54	3,5	2,5	15°	10° ATB	285.654.14M	14
350	30	Two-Sided Melamine	72	3,5	2,4	15°	45° TCG	237.072.14M	22
350	30	Two-Sided Melamine	72	4,4	3,2	16°	TCG	282.072.14M	25
350	30	Wood & Derivatives	72	3,5	2,5	15°	10° ATB	285.072.14M	12
350	30	Two-Sided Melamine	84	3,5	2,5	10°	TCG	281.084.14M	19
350	30	Two-Sided Melamine	84	3,5	2,5	10°	TCG	281.684.14M	18
350	30	Wood & Derivatives	84	3,5	2,5	10°	15° ATB	285.084.14M	12
350	30	Wood & Derivatives	84	3,5	2,5	10°	15° ATB	285.684.14M	14
350	30	Two-Sided Melamine	108	3,5	2,5	10°	TCG	281.108.14M	19, 25
350	30	Two-Sided Melamine	108	3,5	2,5	5°	TCG	281.708.14M	18
350	30	Two-Sided Melamine	108	3,5	2,5	5°	40° ATB	283.108.14M	15
350	30	Wood & Derivatives	108	3,5	2,5	5°	15° ATB	285.108.14M	13
350	30	Wood & Derivatives	108	3,5	2,5	5°	15° ATB	285.708.14M	14
350	30	Two-Sided Melamine	108	3,5	2,5	10°	FFT	295.108.14M	18
350	30	Aluminium	108	3,2	2,5	-6° Neg.	TCG	297.108.14M	27
350	30	Multi-Rip	24+6	4,2	2,8	18°	10° ATB	277.024.14M	10
350	30	Multi-Rip	28+4	3,5	2,5	18°	10° ATB	279.028.14M	9
350	32	Aluminium	92	3,2	2,5	5°	TCG	284.092.14P	26
350	32	Aluminium	108	3,2	2,5	5°	TCG	284.108.14P	26
350	32	Aluminium	108	3,2	2,5	-6° Neg.	TCG	297.108.14P	27
350	35	Wood	28	3,5	2,5	20°	10° ATB	293.028.14R	11
350	35	Wood & Derivatives	54	3,5	2,5	15°	10° ATB	285.054.14R	12
350	35	Wood & Derivatives	84	3,5	2,5	10°	15° ATB	285.084.14R	12
350	35	Wood & Derivatives	108	3,5	2,5	5°	15° ATB	285.108.14R	13
350	50	Two-Sided Melamine	72	4,4	3,2	16°	TCG	282.072.14T	25
350	60	Two-Sided Melamine	72	4,4	3,2	16°	TCG	Y282.072.14U	25
350	60	Multi-Rip	28+4	3,5	2,5	18°	10° ATB	279.028.14U	9
350	70	Multi-Rip	36	3,5	2,5	18°	10° ATB	278.036.14V	9
350	70	Multi-Rip	24+6	4,2	2,8	18°	10° ATB	277.024.14V	10
350	70	Multi-Rip	28+4	3,5	2,5	18°	10° ATB	279.028.14V	9
350	75	Two-Sided Melamine	54	4,4	3,2	16°	TCG	282.054.14X	25
350	75	Two-Sided Melamine	72	4,4	3,2	16°	TCG	282.072.14X	25
350	80	Two-Sided Melamine	54	4,4	3,2	16°	TCG	282.054.14W	25
350	80	Two-Sided Melamine	72	4,4	3,2	16°	TCG	282.072.14W	25
350	80	Multi-Rip	28+4	3,5	2,5	18°	10° ATB	279.028.14W	9
355	25,4	Metal & Steel	72	2,2	1,8	0°	8° FWF	226.072.14	28
355	25,4	Metal & Steel	90	2,2	1,8	0°	8° FWF	226.090.14	28
355	25,4	Stainless Steel	90	2,2	1,8	10°	8° FWF	226.590.14	28
355	30	Two-Sided Melamine	72	4,4	3,2	16°	TCG	S282.03556	25
355	30	Metal & Steel	90	2,2	1,8	0°	8° FWF	226.090.14M	28
355	30	Stainless Steel	90	2,2	1,8	10°	8° FWF	226.590.14M	28
355	65	Two-Sided Melamine	72	4,4	3,2	16°	TCG	282.072.14J2	25
380	60	Two-Sided Melamine	72	4,4	3,2	15°	TCG	282.072.15U2	25
380	60	Two-Sided Melamine	72	4,8	3,5	16°	TCG	282.072.15U	25
355	80	Two-Sided Melamine	72	4,4	3,2	16°	TCG	282.072.14W2	25
380	80	Two-Sided Melamine	72	4,4	3,2	16°	TCG	282.072.15W	25

D mm	B mm	MATERIALS/APPLICATION	Z	K mm	P mm	α	β	ORDER NO.	PAGE
400	30	Construction Materials	28	3,2	2,2	15°	5° ATB	286.028.16M	11
400	30	Wood & Derivatives	36	3,5	2,5	20°	10° ATB	285.036.16M	11
400	30	Wood & Derivatives	48	3,5	2,5	20°	10° ATB	285.048.16M	12
400	30	Two-Sided Melamine	60	4,4	3,2	16°	TCG	282.060.16M	25
400	30	Wood & Derivatives	60	3,5	2,5	10°	15° ATB	285.060.16M	12
400	30	Wood & Derivatives	60	3,5	2,5	10°	15° ATB	285.660.16M	14
400	30	Two-Sided Melamine	72	4,4	3,2	16°	TCG	282.072.16M	25
400	30	Wood & Derivatives	96	3,5	2,5	10°	15° ATB	285.096.16M	13
400	30	Wood & Derivatives	96	3,5	2,5	10°	15° ATB	285.696.16M	14
400	30	Wood & Derivatives	120	3,5	2,5	10°	15° ATB	285.120.16M	13
400	30	Aluminium	120	3,8	3,2	-6° Neg.	TCG	297.120.16M	27
400	30	Multi-Rip	28+6	4	2,8	18°	10° ATB	279.028.16M	9
400	32	Aluminium	96	3,8	3,2	5°	TCG	284.096.16P	26
400	32	Aluminium	108	3,8	3,2	-6° Neg.	TCG	297.108.16P	27
400	60	Two-Sided Melamine	72	4,4	3,2	16°	TCG	282.072.16U	25
400	70	Multi-Rip	28+6	4	2,8	18°	10° ATB	279.028.16V	9
400	75	Two-Sided Melamine	60	4,4	3,2	16°	TCG	282.060.16X	25
400	75	Two-Sided Melamine	72	4,4	3,2	16°	TCG	282.072.16X	25
400	80	Two-Sided Melamine	60	4,4	3,2	16°	TCG	282.060.16W	25
400	80	Two-Sided Melamine	72	4,4	3,2	16°	TCG	282.072.16W	25
420	32	Aluminium	96	3,8	3,2	5°	TCG	284.096.17P	26
420	80	Two-Sided Melamine	72	4,4	3,2	16°	TCG	282.072.17W	25
430	65	Two-Sided Melamine	72	4,4	3,2	16°	TCG	Y282.072.17J	25
430	75	Two-Sided Melamine	72	4,4	3,2	16°	TCG	282.072.17X	25
430	80	Two-Sided Melamine	72	4,4	3,2	16°	TCG	282.072.17W2	25
450	30	Construction Materials	32	3,8	2,8	15°	5° ATB	286.032.18M	11
450	30	Wood & Derivatives	36	3,8	2,8	20°	10° ATB	285.036.18M	11
450	30	Wood & Derivatives	54	3,8	2,8	15°	15° ATB	285.054.18M	12
450	30	Wood & Derivatives	66	3,8	2,8	10°	15° ATB	285.066.18M	12
450	30	Two-Sided Melamine	72	4,4	3,2	16°	TCG	Y282.072.18M2	25
450	30	Aluminium	140	3,8	3,2	-6° Neg.	TCG	Y297.140.18M	27
450	30	Aluminium	108	3,8	3,2	5°	TCG	284.108.18M	26
450	30	Aluminium	108	3,8	3,2	-6° Neg.	TCG	297.108.18M	28
450	32	Aluminium	108	3,8	3,2	-6° Neg.	TCG	297.108.18P	28
450	60	Two-Sided Melamine	72	4,8	3,5	16°	TCG	282.072.18U	25
450	80	Two-Sided Melamine	72	4,8	3,5	16°	TCG	282.072.18W2	25
500	30	Construction Materials	36	3,8	2,8	15°	5° ATB	286.036.20M	11
500	30	Wood & Derivatives	44	4	2,8	20°	10° ATB	285.044.20M	11
500	30	Wood & Derivatives	60	3,8	2,8	15°	15° ATB	285.060.20M	12
500	30	Wood & Derivatives	72	3,8	2,8	10°	15° ATB	285.072.20M	12
500	30	Aluminium	120	4	3,2	-6° Neg.	TCG	297.120.20M	28
500	30	Aluminium	120	4	3,2	5°	TCG	284.120.20M	26
500	32	Aluminium	120	4	3,2	5°	TCG	284.120.20P	26
500	32	Aluminium	120	4	3,2	-6° Neg.	TCG	297.120.20P	27
500	60	Two-Sided Melamine	72	4,8	3,5	16°	TCG	282.072.20U	25
500	80	Two-Sided Melamine	72	4,8	3,5	16°	TCG	Y282.072.20W	25
550	30	Construction Materials	40	4,2	3,2	15°	5° ATB	286.040.22M	11
550	30	Wood & Derivatives	60	4,2	3,2	10°	15° ATB	285.060.22M	12
550	30	Wood & Derivatives	96	4,2	3,2	10°	15° ATB	285.096.22M	12
550	100	Two-Sided Melamine	72	5,2	3,5	16°	TCG	282.072.22A	25
600	30	Construction Materials	40	4,2	3,2	15°	5° ATB	286.040.24M	11
600	30	Wood & Derivatives	66	4,2	3,2	10°	15° ATB	285.066.24M	12
700	30	Construction Materials	46	4,4	3,2	15°	5° ATB	286.046.28M	11
700	30	Wood & Derivatives	72	4,4	3,2	10°	15° ATB	285.072.28M	12

# Saw Blades for Portable Machines

MACHINE	DxB mm
<b>AEG</b>	
HK 125	120x20
HK 125 A, HK 125 B, HK 125 H	125x20
TKS 42, PC 300	132x20
HK 40, TK 40, TKS 42	140x20
HK 86, HK 707	143x19
HK 45, HK 717, HK 727	150x19
AHK 52, HK 45 A, HK 46, HK 46 S, HK 46 N, HKS 46, HKS 46 S, HKS 46 N, HK 50, HK 52, HKS 52, HK 737	150x20
HK 55, HK 55 A, HK 55 B, HKS 55,	160x20
HK 160 A, HK 160B, KS 55 S, KS 55 SE	190x30
HKS 64 A, HK 65, HK 65 A, HKS 65,	
HKS 65 A, HK 66, HKE 66, HKS 66,	
HKSE 66, HK 190, K 66, K 66 E, K 66 S,	
K 66 SE, KS 65, KS 66 S	
HK 200	200x25
HK 201	200x30
HK 75, HK 75 A, HKS 75	210x30
HKS 35, HKS 85	230x30
HK 240	240x30
MK 65	280x30
<b>ALKO</b>	
Basic 205 GK	205x18
Pro 250 GK	250x20
Basic, HS 3, HS 4, Hobby, Holzmeister H,	315x30
Holzmeister S, Holzmeister NHS, Pro-X	
W 450, W 500 450x30	
W 50 Profi, W 450, W 500	500x30
RM 60, W 60	600x30
RM 70, RZ 70, TWM 70, TWZ 700, W 70	700x30
<b>ALPHA-TOOLS</b>	
KS 250	205x18
<b>ATIKA</b>	
Toptronic	250x30
ATK 315 H, BTA 90, HAT 315	315x30
ABH 400, ABK 400, BTH 400, BTK 400	400x30
ABH 450, ABK 450, ATU 450,	450x30
BTH 450, BTK 450, BTU 450, BWK 450	
ABH 500, ABK 500, BTH 500,	500x30
BTK 500, BTU 500, BWK 500	
<b>AVOLA</b>	
LH 315, TZV 315, TVZ 315 W	315x30
TZH 350, TZH 350 W 350 30, ZB 400,	450x30
ZBV 400 400 30IC 450, ZB 450, ZBV 450	
ZB 500, ZBV 500	500x30
BWS 550	550x30
KWK 600, RK 600	600x30
BWS 700, BWT5 700, KWK 700	700x30
<b>BLACK &amp; DECKER</b>	
D 984, D 985, DN 55, DN 56,	125x12,75
DN 254, DN 984, DN 985	
KC 1440 SK	136x10
BD 227, BD 228, BD 846, CD 600, DN 227,	140x12,75
DN 227 H, KS 40, KS 227, KS 840, KS 846,	
P 3501	
P 88-09 (Akku, 12 V)	150x20
BD 228, BD 228 CK, BD 228 L,	156x12,75
DN 57, DN 228, SR 352, SR 352 E, P 3601	
BD 855, GKS 54 CE, KS 55, KS 855, KS 855 N,	160x16
M 336, M 975, M 976 U 336, U 975, U 976	
BD 229, BD 865, BD 865 E, DN 59, DN 229,	180x16
DN 820, GD 60, HD 100, HD 1000,	
HD 1200 P, HD 2062, KS 65 K, KS 865, KS	
865 E, KS 865 KN, SEC 718, SR	
300, SR 362 E, P 37-03, P 37-05	
HD 1200	180x20
BD 365	190x30
M 338, U 338	200x16
BD 88, BD 800, DN 800,	210x30
DN 810, HD 2075 S HD 20755,	
KS 800, KS 805, KS 810, KS 810 A,	
P 38-02, PS 174, SEC 818, SR 700	
<b>BOSCH</b>	
GUF 4-22 A, PSF 22 (Schatten-fugensäge)	105x20
PKS 38, PKS 40, PKS 40 S, S 43	130x16
1551, 1559	140x20
GKS 12 V, GKS 46, PKS 46,	150x16
PKS 416, PKS 48, S 1, S 33	
GKS 24 V, GKS 54, GKS 54 C,	160x16
GKS 54 CE, GKS 54 E, GKS 59,	
KS 550, PKS 54, PKS 54 CE	
1552, 1556, 1563, GKS 55	170x30
0550, 1550, 1553, 1557, 1560	180x30
P 300, PKS 65	190x16
0051, 1553, 1564, GKS 65, GKS 66,	190x30
GKS 66 CE, GKS 68 B, GKS 68 BC,	
GKS 68 CE, P 30, PKS 66, PKS 66 CE	
0551, 1561	200x30
1554, 1558, 1565, 1588, GKS 72 S	210x30
GCM 8 S	216x30
0052, 0552, 1562, 1566, 1662, GKS 85 S	230x30
1555	240x30
GCM 10, GCM 10 S, GCM 10	250x30
SD, GTS 10	250x30
GCM 12, GCM 12 S	305x30

MACHINE	DxB mm
<b>CASAIS</b>	
SC 650	150x20
VSC 65	200x30
HKS 2000	210x30
SC 320	230x30
<b>DEWALT</b>	
DW 935 K, DW 936 K	136x10
DW 351	150x20
DW 007 K, DW 007 KH	165x10
DC 390 KA, DC 390 KA/3, DC 390 KB	165x20
DW 62	184x16
DW 365	190x30
DW 700, DW 701, DW 707	216x30
DW 383	235x30
DW 86	240x30
DW 100, DW 110, DW 111	250x16
DW 120, DW 125, DW 150, DW 170, DW 250,	250x30
DW 252, DW 320, DW 702, DW 703, DW 710,	
DW 742, DW 743, DW 744, DW 720 K,	
DW 746 K, DW 1251, DW 1370, DW 1501,	
DW 1503	
DW 709, DW 711	260x30
DW 721, DW 722 K, DW 725 K, DW 726 K,	300x30
DW 810, DW1370, DW 1935/31L, 142 DS,	
160 DS, 1635, 1875, 2155	
MC 20	300x32
DW 704, DW 705, DW 706,	305x30
DW 708, D 27105	350x30
DW 728 K, DW 729 K, 1600 S, C 14	
C 14, 1600 S, 1635 GL, 2155 G	400x30
6 K, 6 L, DA 1635	500x30
<b>EINHELL</b>	
BT-CS 1200, HES 55, HES 160	160x20
RT-CS 165	165x16
BHS 1300	184x16
BT-CS 1400	190x20
RT-CS 190 L	190x30
BT-TS 800	200x16
HES 200	200x30
RT-TS 920	205x16
RT-FF 1220 U	205x30
BT-MS 210, BT-SM 2050, KGST	210x30
210, RT-SM 305 L, RT-TS 1221	
KGT 500	250x20
BT-MS 250 L, BT-SM 3100,	250x30
BT-TS 1500 U, KGS 250, KGS, 300 UG,	
KGS 301, KGS 330, KGTN 245, KGTN 250,	
RT-SM 430 U, RT-TS, 1725 U, RT-TS 1825 U,	
RT-UD, 1825, RT-UD 1825, RT-XM 305 U	
RT-SM 330 U	305x30
RT-CC 315 U, RT-TS 2031 U, RT-TS 2231 DU	215x30
BT-LC 400/1	400x30
BT-LC 500	450x30
BT-LC 700 D	700x30
<b>ELEKTRA BECKUM</b>	
Multi 180	200x30
KS 205	205x18
KS 210, GKS 255, P200, PK 200,	210x30
PK 220, UK 220 W, UK 220 E	
Secanta	220x30
PK 250, PK 255, KGT 500, KGS	250x20
300, KGT 550, UK 330, KS 250	
KGS 250, KGS 250 K, KGS 300, KGS 301,	250x30
KGS 303, KGS 330, KGS 331, KGT 250,	
KGT 500, KGT 501, KGT 550, KS 250, KS	
304, Multi 260, Multi 310, PK 250,	
PK 255, PK 2800, PK 3100, PK	
4200, PK 6000, PKF 255, UK250, UK 330	
PK 300, PK 300 K, PKV 300 G	300x30
KS 304	304x30
1800, 2200, 2800, 3100, 4100,	315x30
Combi und Standard HS 315,	
Combi HSG, TKHS 315, TK, HS 315 E	
TK 350	350x30
BKH 400, BKS 400, BKS 450,	400x30
BS 3100 W, BS 4200, BS 5500 W	
BKH 450, BKS 450, BS 6000 D,	450x30
BS 8000 D	
BKH 450, BS 6000 D, BS 8000 D	500x30
BW 400, BW 600, BW 700	600x30
BW 700, BW 750, BW 4000	700x30
<b>ELU/DEWALT</b>	
MKK 26	86x12
MH 25, MH 25 K	100x12
DS 140 Double Schatten-fugensäge	105x22
MHA 14 KA, MHA 18 KA	136x10
MH 151, MH 151/10, MHA 151	150x20
MH 18, MH 30, MH 82, MH 182, PS 174	150x30
MH 55, MH 155	170x30
MH 65	180x30
MH 165, MH 265	190x30
MH 30, MH 82, MH 182	215x30
ETS 41, PS 174, PS 274, PS 244 E	216x30
MH 85, MH 286	240x30

MACHINE	DxB mm
<b>ELU/DEWALT (vervolg)</b>	
ETS 21, ETS 23, ETS 31, ETS 33, KSU 101,	250x30
RAS 1251, RAS 1253, RKS 1251, RKS 1253,	
TGS 71, TGS 170, TGS 171, TGS 172,	
TGS 173, TGS 271, TGS 273	
EMTS 711	260x30
ETS 3001, ETS 3003, PS 374	300x30
EMS 705, PS 374	305x30
RKS 1603	350x30
MTS 24	355x25,4
RSA 133/25	500x30
<b>ELUMATEC</b>	
KS 101, MGS 460	254x32
DG 163, RS 160, TS 161	280x32
KS 101, MGS 460	300x32
MGS 72/04, MGS 73/23	330x32
DG 79/03-05, DG 79/50, SA 73/25	330x32
DG 79/30-32, DG 79/51, MGS	380x32
72/30, MGS 73/33, SA 73/35	
DG 102, DG 104, DG 140, MGS	420x30
105, MGS 461, SA 103/25	
DG 142, MGS 142, SA 142	500x30
DG 204, DG 240, MGS 205	550x30
<b>EMCO</b>	
Universal	200x15
Rex 2000, Super 1011	250x20
KS 80, MK 81	250x30
<b>EUMENIA</b>	
ML 50 L	220x30
<b>FEIN</b>	
SSK 646, SSL 646	150x20
SSK 660	160x20
SSK 661	210x30
<b>FELDER</b>	
KF 700	250x30
BF 6-26, BF 6-31, BF 6-41,	315x30
BF 31, K 37, KFS 37	
<b>FELISATTI</b>	
TP 751	150x20
TP 756	160x20
TP 765	190x20
TP 781	230x30
T 84, T 85, T 87, T 770, T 771,	250x20
T 777, T 777 B, T 777 CE, T 778, T 867 GS	
M 74, M 75, M 76, M 77, T 84,	250x30
T 85, T 87, T 88	
T 82, T 83, T 91, T 91 CE, T 97 CE	300x30
<b>FERM</b>	
FZT 250, FZT 250 EN	250x30
<b>FESTOOL</b>	
AUF 35-S3, AUF 35-S4	105x20
AUF 35-S2	120x20
AF 45 E, AXF 45	150x30
AP 55, AP 55 E, AP 55 E-FS, AP 55 FS,	160x20
ATF 55, ATF 55 E, ATF 55 EB, ATF 55 E-FS,	
ATF 55 FS, AP 55 EB, TS 55, TS 55	
EQ, TS 55 EBO, TS 55 Q	
AAU, AU 50, AUF 50	160x30
AM 42 A, AM 42 S, AM 42 T, AMT 42 S,	170x33
AT 55 B, AT 55 C, AT 55 E, ATU 42-S,	
AU 42 S, AUT 42 S, AXT 50 LA, AXT 55	
AU 55 S, AU 60 P, AU 60 S, A	180x30
UP 60 S, AUF 60 S	
AP 65, AP 65 E, AP 65 E-FS, AP 65 EB,	190x30
AP 65 EB-FS, AT 65, AT 65 E, AT 65 E-FS,	
AT 65 EB, AT 65 EB-FS	
AD 65, AP 68 E, AP 65 S, AU 65 S,	200x30
AUP 65 S, AUT 65 S, AXP 65, AXP 200	
TS 75, TS 75 EBO, TS 75	210x30
EBQ-FS, TS 75 EQ	
Symmetric SYM 70	216x30
AU 77 S	220x30
CS 70, CS 70 EB	225x30
AU 80 S	230x30
AP 85, AP 85 E, AP 85 E-FS, AP 85 E-TS,	240x30
AP 85 EB, AP 88, AP 88 E, AXP 85	
AD 85, AD 100, AE 85, AE 88	250x30
Kapex KS 88, Kapex KS 120	260x30
AXP 130, AXP 132 E, BD 125	350x30
BD 145, BD 145/1	400x30
BD 170	450x30
<b>FEZER</b>	
KG 20	200x18
KG 205	205x18
KG 25	250x32
KG 30	300x32
KG 40 S	400x32
AB 600	600x32
<b>FLOTT/FLOTTJET/KRAKU</b>	
1000, 2000, Profi 3000	250x20
KS 1011, TKS 2011 D, TKS 2011 W,	250x30
KS 2011 D, KS 2011 W, KS 2012, 3011,	
Profi 2000, Profi 2001,	
Profi 3011, Uni-Profi 2011	
FKS 3000, KKS 305 M	315x30



# Saw Blades for Portable Machines

MACHINE	DxB mm
<b>GRAULE</b>	
AKF F, AKF 4/200	200x40
AKF 2, AKF 4/250, AKF 6/250, KS, TS	250x40
85 N, AGL, AGT, AKF 6/300, Typ 85, ZS 85	300x40
Typ 135, ZS 135, ZS 135 N	350x40
Typ 170, ZS 170, ZS 170 N	420x40
ZS 200	520x50
<b>GÜDE</b>	
GTK 721	205x18
GTK 800	205x20
GKS 1100 P, GRK 210/300,	210x30
GUKS 2100, KT 210	
GFO 1401	216x30
GKS 250 L, GKS 250 T, GRK	250x20
250/300, GRK 250/500	
TK 2500 UG, GFO 1801	254x20
TK 2400 ECO	254x30
GTKS 315	315x30
GWS 400 Eco	400x30
GWS 450 Eco	450x30
FP 600 Plus, GWS 600 EC,	600x30
GWS 600 HM, GWS 600	
DTW 700, DWS 700, DWS 700 Z, GWS 700,	700x30
FP 700 Plus, GWS 700 HM, GWS 700 EC,	
PRS 700/7 HMF, PTW 700/7	
HMF, PWS 700/7 HMF	
<b>HAAGER</b>	
HTK 200	200x30
HKGS 250, HMS 10 RA	250x20
GKS 250 HR, HBTS 10 A	250x30
HTK 300	300x30
<b>HAFFNER</b>	
RF 60	100x20
KSU 40	120x20
KSU 105, KSU 125	125x20
KSU 50	160x20
KSU 110	170x30
KSU 60, KSU 113	180x20
KSU 60 alt	200x30
GL 136	200x20
AKS	210x30
AS 75, KS 75, RS 75	220x30
140, KL 177, KL 178, KSU 118	220x30
HSU 85, KL 176, KS 85, KSU 85,	250x30
SP 187, US 85	
AKS, GS 1, GS 2W, GS 2 D, GS 150, GS 163,	250x30
GS 165, GS 166, KL 140, SP 189, SP 195,	
SP 196, SP 197, SP 198, TGS 161,	
TGS 162, TGS 163, TGS 198	
MK 251 B	300x32
950, GS 146, GS 147, GS 148, GS 155,	330x30
GS 156, GS 157, GS 158, GS 165, GS 166,	
GS 183, GS 183 M, KS 120, KS 155,	
SP 221, SP 223, SP 224, TGS 168, TGS 169,	
TGS 200, TK 42, US 151	
DGS 180, DGS 182, GSM 180, GSA 180	350x30
GS 159, GS 160	340x30
MK 350 Varío	400x32
DGS 123, DGS 124, DGS 180, DGS 181,	500x30
DGS 182, DGS 184, DGS 184 E, DGS 188,	
DGS 185, GS 183, GS 184, GS 188 M,	
GS 188 P, GSA 184 E, KS 155, ZS 640,	
ZS 800	
DGS 187, DGS 202, GS 161,	600x30
GS 162, US 161, US 162 30	
<b>HANNING</b>	
TK 20 N, TK 20 S, TK 200,	200x16
TK 300, ZK 205, HKS 250	250x16
3 VS, HTK 315/1.6, HTK 315/2.1,	315x30
HTK 315/3.0, HTK 315/3 SV, HTK 315/4.0	
<b>HANSEATIC</b>	
PSC 160 D	160x20
<b>HILTI</b>	
WSC 55	160x20
WSC 85	230x30
<b>HERCULES</b>	
KG 205	205x16
TKS 250 UV	250x16
BK 315/1	315x30
<b>HITACHI</b>	
C 5 Y	125x20
C 5, FC 5, FC 5 SA	150x20
C 6, C 6 DA, C 60 A, FC 65 A, FC 6 SA	160x20
C 6 BU, C 6 U, C 6 DD-Akku, FC 6 SB	165x30
C 6 SA, PSU 6	170x30
C 7 U, C 7 BU, FC 7 SA, PSM 7, PSM 7 A,	190x30
PSU 7 C 8 U, C 8 FA, PSM 8, PSU 8	210x30
C 8 FC, C 8 FS	216x30
C 9 U	235x30
PSM 9, PSM 9 A, PSU 9	240x30
U 210	250x30
C 10 FB, C 10 FCA, C 10 FCS, C 10 RA	255x30
C 13 U, PSU 13	335x30
C 15 FC	380x30
<b>HOLZ-HER (REICH)</b>	
Derby 2110, Mosquito 2111, Mosquito 2171	132x30

MACHINE	DxB mm
2260, 2270	140x30
2103, 2104, 2105, 2106, 2107,	160x30
2108, HKU 50	
1563, 2115, 2266, 2271, 2281	170x30
2112, 2272, 2291, HKU 55	180x30
2114, 2116, 2117, 2119, 2126,	190x30
2127, 2269, 2282	
2113, 2292, 2555, HK 201	200x30
2267, 2284, PKS 267	210x30
Leistensäge 2141	216x30
2267, 2274, 2279, 2284, HKU 75, PKS	220x30
2118, 2120, 2171, 2279, 2293, 2294	230x30
2128, 2268, HKD 65	240x30
HKD 85, HKD 275, HKD 1212, PKS 1210,	300x30
PKS 1211, PKS 1213, PKS 1225,	
PKS 1230 303	
HKS 130, HKS 150, HKS 276	350x30
HKS 2136	380x30
HKS 155, HKS 277, HKS B 7 K, BTK 155	400x30
<b>JEPSON</b>	
8219	192x20
9211 D	255x25,4
9312 E, 9430	305x25,4
9314, 9435	355x25,4
<b>KITY</b>	
626	150x20
510, 616, 617, 2617	180x15
0419, 7419, 0618, Kombi 2000,	200x30
Kombi 5023, Junior 6	
618	250x30
1609, 1619, 5619, 6619, 9619 2	70x30
819	315x30
<b>KRESS</b>	
CHKS 6050, CHKS 6055	160x20
CHKS 6060, 1400 HKS, 1500 KS, 1800 KSE	190x20
<b>MAFFEL</b>	
A 35, FS 35, KSS 300, KSP 40	120x20
SF 32, X 40, XE 40	125x20
A 55, B 55, FU 50, KSP 55, KSP 55 F,	160x20
KSS 330, KSS 400, KST 55, MKS 55, MS 55,	
MT 55, PS 52, PSS 3000, PS 3100, X 55,	
XS 55	
KS 320	160x30
Erika 55	180x30
Erika 60, KSP 65, KSP 65 F, MS 65, MKS 65	190x30
B 65, X 72	200x30
AS 65, FUS 65	210x20
MS 75, MKS 75	210x20
Erika 70 E, MKS 85	225x20
KSP 85, KSP 85 FC	230x30
B 82	240x30
Erika 85, MS 85, MKS 85, MKS 85 S	250x30
A 85, Erika 65, FS 65, FU 585, FUS 85	280x30
Erika 70 L, Erika 70 K	290x20
Biberex, MKS 105, Monika,	315x30
TKF 85 L, TKF 85 K	
Biber, FS 85	325x30
MKS 130 EC	330x30
MKS 125, MKS 125 E	355x30
MKS 145, MKS 145 EC	370x30
BK 3, BKS 4, FS 130, FS 130 S, TD 3, VKS 1	400x30
MKS 165, MKS 165 EC, FS 130K	410x30
TDH 4, TDH 425	425x30
BK 4, BKV 4, BKS 5, FSG 165,	450x30
MKS 185 EC, TDH 5, TDH 450	
BKV 5, BKS 6, TDH 5-170	500x30
FSG 200	550x30
FSG 240 K	640x30
<b>MAKITA</b>	
4341 S, BTK 0, KS 0852 S, 61+2, 52 S	150x20
5600 NB, 5600 RDW	160x20
167, 0846 S, 0946 S, 5600 BR, 5603 R,	165x20
5604 R, TK 1256, KS 1155, KST 1157 S,	
KSTE 1357, S-Signal, SBTK 1, SR 1600	
5500 S, 5800 B, 5801 B, 6317 S	180x20
5800 BR, SR 1800	185x20
4346 S, KS 65, KS 1266 S, KS	190x20
1468, KS 4345 S, KSE 1668, TK 5348	
5703 R, 5705 R, 5017 RKB	190x30
Radial-Eudora 5700	200x25
LS 0810, SR 2100	210x25
KGS E 1670 S, KSE 1678 S	210x30
6322 S	220x30
SR 2300, SR 5900 B, SR 5900 BR	235x25
5903 R	235x30
KS 1785, KS 6323 S	240x30
LS 1013, LS 1014	260x25
SR 2600	266x25
5103 R, SR 2600	270x30
5100 BR	335x25
5143 R	355x30
<b>METABO</b>	
F 0520	100x22
4340 S, BHK 2, BHK 3, 4345 S 140 20	140x13
4341 S, BTK 0, 61 + 2, KS 52,	150x20
KS 0846 S, KS 0852 S	

MACHINE	DxB mm
BTK 1, KS 1155 S, Magnum, TK 1256	165x20
6317 S	180x20
KS 655, KS 1266, KS 1468 S,	190x20
KS 4345 S, KS 4346 S, KS5348,	
KSE 1668, Robert	
KGSE 1670, KSE 1678 S-Signal,	210x30
Magnum TK 1066, TKU 225	
6322 S	220x30
KS 1785 S, KS 6323 S	240x30
TK 1633, TKU 1633, TKU 1693	250x30
TK 1688, TK 1688 D	315x30
<b>PANASONIC</b>	
EY 3501	110x20
EY 3530	135x20
<b>PERLES</b>	
25 S	100x12
SC 47 C	140x20
KS 50, Peugeot, SC 53 C	150x20
FIP 50 S	180x20
KS 85	230x30
<b>PROTOOL</b>	
CSP 55-2, CSP 56 EQ,	160x20
CSP 56 Q, CSP 68	
CSP 68 E	190x30
CSP 85	240x30
<b>ROBLAND</b>	
K 210 - 260	240x30
X 260	250x30
K 310, X 310	300x30
<b>ROCKWELL</b>	
346, 63416	170x16
315, 4500, 63417	184x16
368, 63418	220x20
<b>SCHEER</b>	
HM 5, HM 6	100x22
MS 50	150x16
MS 45, MS 45 E	150x20
FM	160x16
MS 55	160x20
FM	180x16
MS 65, MKS 65	190x30
MS 70	200x30
MS 80	220x30
MS 85	230x30
FM 10, A 3100, A 4200	240x30
<b>SCHEPPACH</b>	
KG 205	205x18
TS 2000	200x30
Capas 1, Capas 2	216x30
KG 250, TKG 250, TS 2500	250x20
KSE 250, TS 2500, KG 260, TKG	250x30
260, KG 280, TKG 280	
Capas 3, TKG 305 E	305x30
TS 315 GT, TS 400, TS 4010, TKU	315x30
BSH 400	400x30
BSH 500	500x30
<b>SKIL</b>	
22501 B	125
5140 A, 5140 B, 5240	130
532	140
533, 553, 5246, 1800 H, 1850 H	150
416 H, 534, 536, 552 B, 1408 H,	160
1409 H, 1410 H, 1440 H, 5750 A	
77 U, 537 U, 553 B, 553 H,	184
559 U, 574 U, 599 U, 857	
1865, 1866, 5266, 5565, 5566,	190
5666, 5866 A, 1899, 1965 U, 1986	
554 B, 554 H, 825, 858, 1524 H, 1873 H	210
555 H, 1525 H, 1886 H, 1985 U	230
1523 H, 1526 H, 1899 H	260
<b>STAYER</b>	
CP 50	150x20
KS 700, SC 205, TKS 2000	205x18
SC 250, SC 251, SCU 75	250x20
SC 260, SCE 1610, SLL 250	250x30
TD 305	305x25,4
<b>TIP</b>	
HKS 160	160x20
HKS 200	200x16
TKS 250	250x15,8
TGS 250	250x25,4
<b>ULMIA</b>	
1409 B	160x20
1706, 1708	200x16
1710 S, 1710 R	250x15,8
Gecombinierde Macchine	300x25,4
<b>WEGOMA</b>	
TB 204	105x22
HS 50	150x20
TS 250	250x30
S 4 D, S 4 W	350x30
TS 400	400x30

# QUALITY MATERIALS FOR OUTSTANDING PERFORMANCE

Produced by following state-of-the-art processes and by using high-tech machines, these jig saw blades have been specifically designed for precise cuts on soft & hardwood, plywood, OSB, laminates, plastics, HPL, multiplex panels, metals, ferrous & non-ferrous materials, aluminium, fiberglass and also stainless steel. These are made of four different materials.

## Geometry is important!

### MILLED & SIDE SET TEETH

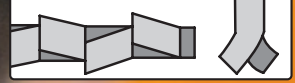

### MILLED & SIDE SET TEETH

Jig saw blades featuring this kind of geometry produce a quick rough cut into soft/hardwood, aluminium, plastic and non-ferrous metals.

### MILLED & WAVY SET TEETH



### MILLED & WAVY SET TEETH

Suitable for fine straight cuts into plywood, soft steel, aluminium, non-ferrous metals and plastic.

### GROUND & SIDE SET TEETH

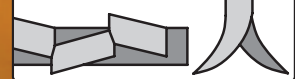

### GROUND & SIDE SET TEETH

Best for quick cuts in wood.

### GROUND & TAPER GROUND TEETH



### GROUND & TAPER GROUND TEETH

This geometric attribute creates fine, clean and precise cuts in wood and plastic.



**High Carbon Steel**  
Great for cutting wood, fiberboard and plastic.



**Bi-Metal with 8% Cobalt**  
Premium bi-metal with 8% Cobalt provides superb results and guarantees long life when cutting metal, non-ferrous, plastic and wood with nails.



**High Speed Steel**  
For cutting harder materials, such as metals, aluminium and non-ferrous metals.



**Tungsten Carbide Tipped**  
For cutting fibercement board, brick, porous concrete, plasterboard, MDF, fiberglass and Eternit®.

## THE RIGHT BLADE FOR THE BEST RESULTS!

Quick reference charts and pictograms help you choose the right blade for your application.

// Wood



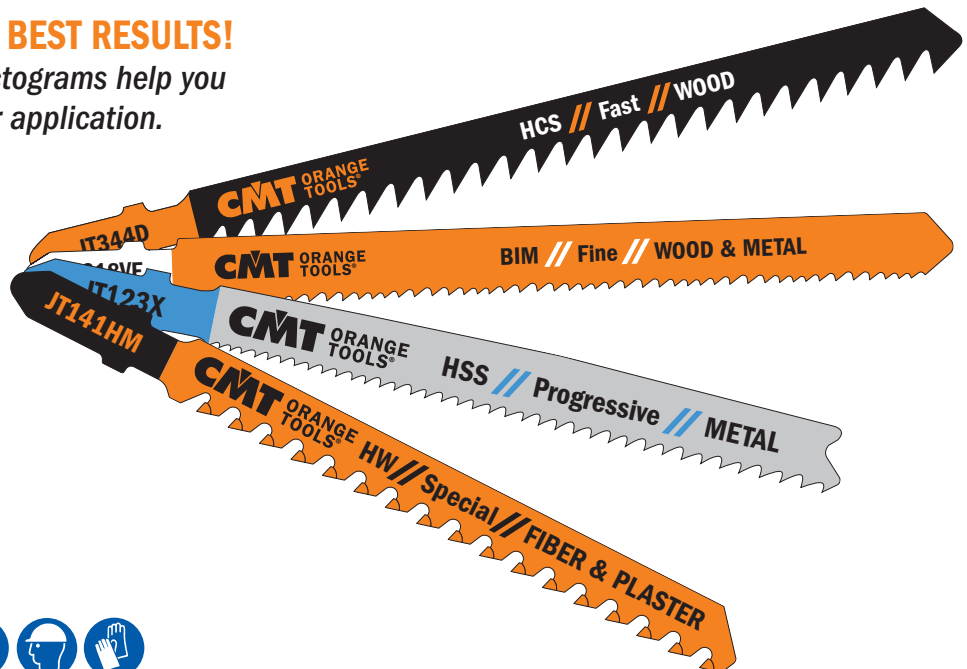

// Wood & Metal

// Metal

// Special



# Guide to Choosing the Most Suitable Jig Saw Blade

Series	Material	Thickness  mm	Line	Fine Straight 	Coarse Straight 	Fine Curve 	Coarse Curve 	Page	
<b>WOOD</b>	<b>Softwood</b>	1,5~15	Fine			<b>JT101A0</b>		54	
		2~15	Basic			<b>JT119B0</b>		53	
		3~65	Fine, Splinter-Free	<b>JT234X</b>					55
		3~30	Fine	<b>JT101B</b>					54
		3~30	Fine, Splinter-Free	<b>JT101BR</b>					54
		4~60	Basic			<b>JT111C</b>			53
		5~60	Fast			<b>JT144D</b>		<b>JT244D - JT244DDC</b>	53
		5~100	Fast			<b>JT344D</b>			54
		7~55	Fine		<b>JT101D</b>				55
	7~65	Fine		<b>JT301CD - JT318VF</b>				55	
	<b>Hardwood</b>	1,5~15	Fine				<b>JT101A0</b>		54
		3~30	Fine	<b>JT101B</b>					54
		3~30	Fine, Splinter-Free	<b>JT101BR</b>					54
		3~65	Fine, Splinter-Free	<b>JT234X</b>					55
		5~60	Fast			<b>JT144D</b>		<b>JT244D - JT244DDC</b>	53
		5~100	Fast			<b>JT344D</b>			54
		7~55	Fine		<b>JT101D</b>				55
		7~65	Fine		<b>JT301CD - JT318VF</b>				55
	<b>OSB</b>	2~15	Basic				<b>JT119B0</b>		53
		3~30	Fine	<b>JT101B</b>					54
		4~60	Basic			<b>JT111C</b>			53
		5~60	Fast			<b>JT144D</b>		<b>JT244D - JT244DDC</b>	53
		7~55	Fine		<b>JT101D - JT318VF</b>				55
	<b>Plywood</b>	1,5~15	Fine				<b>JT101A0</b>		54
		2~15	Basic				<b>JT119B0</b>		53
		3~30	Fine	<b>JT101B</b>					54
		3~30	Fine, Splinter-Free	<b>JT101BR</b>					54
		3~65	Fine, Splinter-Free	<b>JT234X - JT318VF</b>					55
		4~60	Basic			<b>JT111C</b>			53
		5~60	Fast			<b>JT144D</b>		<b>JT244D - JT244DDC</b>	53
		5~100	Fast			<b>JT344D</b>			54
		7~55	Fine		<b>JT101D - JT318VF</b>				55
	<b>Construction Wood</b>	<30	Fine	<b>JT101B</b>					54
		3~65	Fine, Splinter-Free	<b>JT234X</b>					55
		<100	Fast			<b>JT344D</b>			54
		<135	Fast			<b>JT144D</b>			53
	<b>Chipboard</b>	2~15	Basic				<b>JT119B0</b>		53
		3~30	Fine	<b>JT101B</b>			<b>JT101A0</b>		54
		3~65	Fine, Splinter-Free	<b>JT234X - JT318VF</b>					55
		4~60	Basic			<b>JT111C</b>			53
		5~60	Fast			<b>JT144D</b>		<b>JT244D - JT244DDC</b>	53
	<b>Laminated panels Kitchen Tops Worktops</b>	1,5~15	Fine				<b>JT101A0</b>		54
1,5~15		Fine, Long Life	<b>JT101BIF</b>					55	
3~30		Fine	<b>JT101B</b>					54	
3~30		Fine, Splinter-Free	<b>JT101BR</b>					54	
3~65		Fine, Splinter-Free	<b>JT234X</b>					55	
<b>METAL</b>	<b>Sheet metals</b>	1~3	Basic	<b>JT118A</b>		<b>JT218A</b>		56	
		1,5~10	Fast, Long Life	<b>JT123X - JT318VF</b>				55-56	
		2,5~6	Basic	<b>JT118B</b>				56	
	<b>Aluminium, non-ferrous</b>	<30	Fast	<b>JT127D</b>					56
		1,5~10	Fast	<b>JT123X - JT318VF</b>					55-56
	<b>Pipes</b>	<30	Fast	<b>JT123X - JT318VF</b>					55-56
	<b>Inox Sheets</b>	1,5~3	Fast	<b>JT123X - JT318VF</b>					55-56
<b>Sandwich Material</b>	<120	Fast, Flexible	<b>JT718BF</b>					56	
<b>PLASTIC</b>	<b>GRP (Fiberglass) Plastic (PP, PE, PVC, PA, PS)</b>	<30	Fast	<b>JT127D</b>				56	
		<30	Fine	<b>JT101D</b>				55	
		<30	Fast	<b>JT123X</b>				56	
		7~65	Fine	<b>JT301CD - JT318VF</b>				55	
<b>SPECIAL</b>	<b>Plasterboard</b>	5~50	Special		<b>JT141HM</b>			57	
		5~80	Special		<b>JT341HM</b>			57	
	<b>GRP (Fiberglass)</b>	<80	Special		<b>JT341HM</b>			57	
	<b>Fiber cement boards</b>	5~50	Special		<b>JT141HM</b>				57
		5~80	Special		<b>JT341HM</b>				57



# Jig Saw Blades



## JT119B0



PACK Quantity	L mm	I mm	TS mm	TPI		ORDER NO. T Shank
5	76	50	2	12	100	<b>JT119B0-5</b>

Curve cuts on softwood (2 ~ 15mm), plywood, OSB.

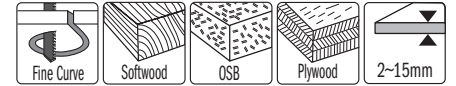
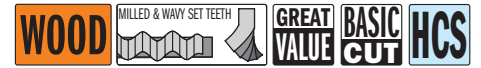

## JT111C



PACK Quantity	L mm	I mm	TS mm	TPI		ORDER NO. T Shank
5	100	75	3	8	100	<b>JT111C-5</b>

Fast coarse cuts on softwood (4 ~ 60mm), plywood, OSB.



## JT144D



PACK Quantity	L mm	I mm	TS mm	TPI		ORDER NO. T Shank
5	100	75	4	6	100	<b>JT144D-5</b>
25	100	75	4	6	10	<b>JT144D-25</b>
100	100	75	4	6	4	<b>JT144D-100</b>

Very fast cuts, straight and coarse, on hard/softwood (5 ~ 60mm), plywood, OSB. Plunge cutting.

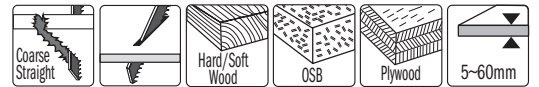

## JT244D



PACK Quantity	L mm	I mm	TS mm	TPI		ORDER NO. T Shank
5	100	75	4	6	100	<b>JT244D-5</b>

Fast, curve, coarse cut on soft and hardwood from 5mm to 60mm, plywood, OSB. Plunge cutting.

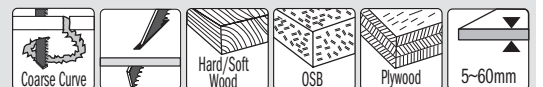

## JT244DDC



PACK Quantity	L mm	I mm	TS mm	TPI		ORDER NO. T Shank
5	100	75	4	6	100	<b>JT244DDC-5</b>

Fast, curve, coarse cut on soft and hardwood from 5mm to 60mm (7/32"~2-3/8"), plywood, OSB. Plunge cutting. Special "DUO" (double) cuts for fast curve.

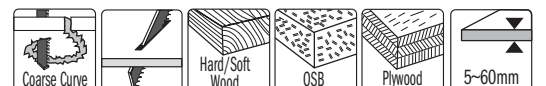

# Jig Saw Blades

## JT344D



Pack Quantity	L mm	I mm	TS mm	TPI		ORDER NO. T Shank
5	132	110	4	6	100	<b>JT344D-5</b>



Very fast cuts, straight and coarse on thick construction timber, hard/softwood (5 ~ 100mm), plywood, OSB.

## JT744D



Pack Quantity	L mm	I mm	TS mm	TPI		ORDER NO. T Shank
3	180	155	4	6	20	<b>JT744D-3</b>



Very fast cuts, straight and coarse on thick construction timber, hard/softwood (5 ~ 135mm) and sandwich material.

## JT101A0

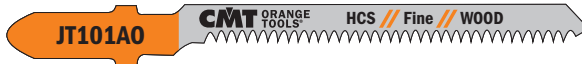
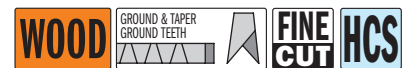

Pack Quantity	L mm	I mm	TS mm	TPI		ORDER NO. T Shank
5	76	50	1,4	20	100	<b>JT101A0-5</b>

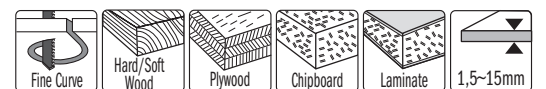

Curved cuts, fine finishing on both sides of surface on hard/softwood, plywood, chipboard, MDF, double sided laminates (1,5 ~ 15mm).

## JT101B



Pack Quantity	L mm	I mm	TS mm	TPI		ORDER NO. T Shank
5	100	75	2,5	10	100	<b>JT101B-5</b>
25	100	75	2,5	10	10	<b>JT101B-25</b>



Fine straight cuts on hard/softwood, plywood, OSB and plastics (3 ~ 30mm). Plunge cutting.

## JT101BR

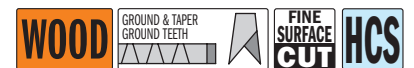

Pack Quantity	L mm	I mm	TS mm	TPI		ORDER NO. T Shank
5	100	75	2,5	10	100	<b>JT101BR-5</b>
25	100	75	2,5	10	10	<b>JT101BR-25</b>



Straight cuts, fine finishing on surfaces, hard/softwood, plywood, OSB, laminated panels, plastics (3 ~ 30mm). Reverse tooth.

# Jig Saw Blades



## JT101D

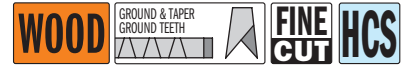

PACK Quantity	L mm	I mm	TS mm	TPI		ORDER NO. T Shank
5	100	75	4	6	100	JT101D-5

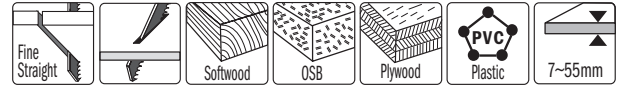

Good straight cuts on hard/softwood, plywood, OSB, plastics (7 ~ 55mm). Plunge cutting.

## JT301CD

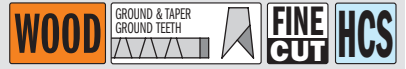
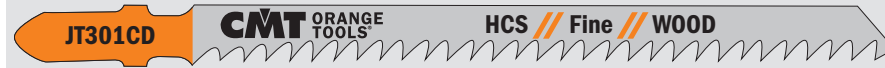

PACK Quantity	L mm	I mm	TS mm	TPI		ORDER NO. T Shank
5	116	90	3	8	100	JT301CD-5

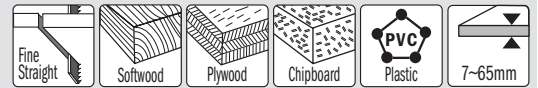

Straight cuts, fine finishing, on hard/softwood, plywood, laminates, plastics (7 ~ 65mm).

## JT234X

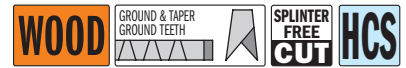

PACK Quantity	L mm	I mm	TS mm	TPI		ORDER NO. T Shank
5	116	90	2-3	8-12	100	JT234X-5

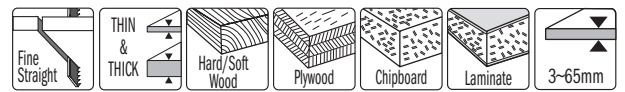

Extra-clean splinter-free straight cuts on hard/softwood, plywood, OSB, laminates (3 ~ 65mm).

## JT101BIF



PACK Quantity	L mm	I mm	TS mm	TPI		ORDER NO. T Shank
5	83	58	1,7	15	100	JT101BIF-5

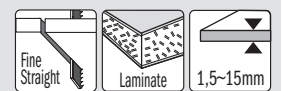

Splinter-free cuts. For all laminates, HPL and multiplex panels (1,5 ~ 15mm).

## JT318VF



PACK Quantity	L mm	I mm	TS mm	TPI		ORDER NO. T Shank
5	132	100	1,7-2,6	10-15	100	JT318VF-5

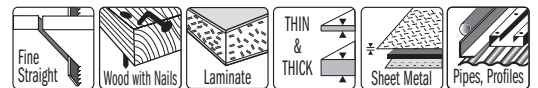

Straight cuts on wood with nails/metal, chipboard and laminate (<60mm), sheet metal, aluminium profiles (3-18mm), glass fiber reinforced plastic/epoxy (<60mm).



# Jig Saw Blades

## JT118A



PACK Quantity	L mm	I mm	TS mm	TPI		ORDER NO. T Shank
5	76	50	1,2	21	100	<b>JT118A-5</b>

Straight cuts on thin sheet metals, ferrous and non-ferrous (1 ~ 3mm).

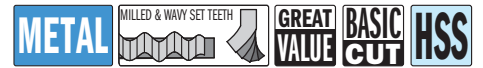

## JT218A



PACK Quantity	L mm	I mm	TS mm	TPI		ORDER NO. T Shank
5	76	50	1,2	21	100	<b>JT218A-5</b>

Curve cuts on thin sheet metals, ferrous and non-ferrous (1 ~ 3mm).

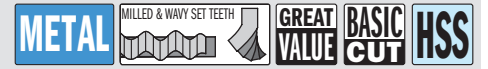

## JT118B



PACK Quantity	L mm	I mm	TS mm	TPI		ORDER NO. T Shank
5	76	50	2	12	100	<b>JT118B-5</b>

Straight cuts on medium-thick metals, ferrous and non-ferrous (2,5 ~ 6mm).



## JT123X



PACK Quantity	L mm	I mm	TS mm	TPI		ORDER NO. T Shank
5	100	75	1,2-2,6	10-21	100	<b>JT123X-5</b>

Straight cuts on thin to thick sheet metals (1,5 ~ 10mm), pipes, profiles in plastic and aluminium (diameter <30mm), stainless steel (1,5 ~ 3mm).

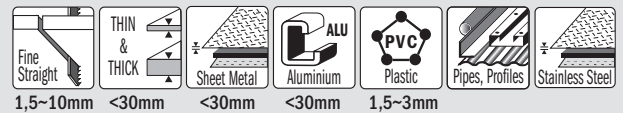

## JT127D



PACK Quantity	L mm	I mm	TS mm	TPI		ORDER NO. T Shank
5	100	75	3	8	100	<b>JT127D-5</b>

Special for aluminium, thin to thick (3 ~ 15mm), pipes and profiles, (diameter <30mm) as well as plastic and fiberglass.

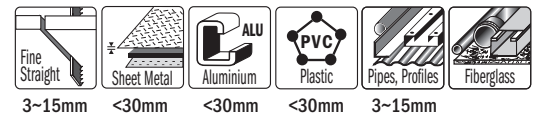

## JT718BF



PACK Quantity	L mm	I mm	TS mm	TPI		ORDER NO. T Shank
3	185	160	1,8	14	20	<b>JT718BF-3</b>

Special for Sandwich Materials & Solid Surfaces (<120mm).

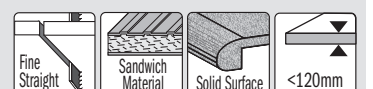

# Jig Saw Blades



## JT141HM

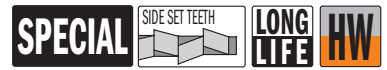

Pack Quantity	L mm	I mm	TS mm	TPI		ORDER NO. T Shank
3	100	75	4,3	6	50	JT141HM-3

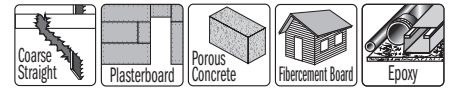

Plasterboard, fiber cement boards (<50mm). Glass fiber reinforced plastic/epoxy (5 ~ 20mm), Eternit®, MDF, HDF.

## JT341HM



Pack Quantity	L mm	I mm	TS mm	TPI		ORDER NO. T Shank
3	132	110	4,3	6	50	JT341HM-3

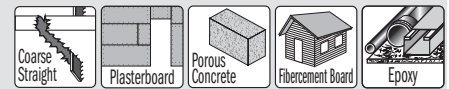

Plasterboard, fiber cement boards (<80mm). Glass fiber reinforced plastic/epoxy (5 ~ 50mm), Eternit®, MDF, HDF.

## JT016 16 piece Jig Saw Blades Set

<b>2 PCS</b>	<b>JT144D HCS</b>	<b>WOOD FAST CUT</b>		5-60mm 1/2" - 3/4"	4mm	TPI 6		
Very fast cuts, straight and coarse, on hard/softwood (5-60mm), plywood, OSB. Plunge cutting.								
<b>2 PCS</b>	<b>JT101B HCS</b>	<b>WOOD FINE CUT</b>		3-30mm 1/8" - 1 1/4"	2.5mm	TPI 10		
Fine straight cuts on hard/softwood, plywood, OSB and plastics (3-30mm). Plunge cutting.								
<b>2 PCS</b>	<b>JT101BR HCS</b>	<b>WOOD FINE SURFACE CUT</b>		3-30mm 1/8" - 1 1/4"	2.5mm	TPI 10 REVERSE		
Straight cuts, fine finishing on the surface, on hard/softwood, plywood, OSB, laminated panels, plastics (3-30mm). Reverse tooth.								
<b>1 PC</b>	<b>JT101BIF BIM</b>	<b>WOOD FINE CUT LONG LIFE</b>		1.5-15mm 1/16" - 5/8"	1.7mm	TPI 15		
Splinter-free cut. Special for all laminates, HPL and multiplex panels (1,5-15mm).								
<b>1 PC</b>	<b>JT101A0 HCS</b>	<b>WOOD FINE CUT</b>		1.5-15mm 1/16" - 3/4"	1.4mm	TPI 20		
Curved cuts, fine finishing on both sides of surface on hard/softwood, plywood, MDF, double sided laminates (1,5-15mm).								
<b>1 PC</b>	<b>JT141HM HW</b>	<b>SPECIAL LONG LIFE</b>		<50mm 1-1/2"	4,3mm	TPI 6		
Plasterboard, fibre cement boards (<50mm), Glass fibre reinforced plastic/epoxy (5-20mm), Eternit®, MDF, HDF.								
<b>1 PC</b>	<b>JT123X HSS</b>	<b>METAL FAST CUT</b>		1.5-10mm 1/16" - 3/8"	1.2-6mm 1/16" - 1/4"	TPI 10-21		
Straight cuts on thin to thick sheet metals (1,5-10mm), pipes, profiles in plastic and aluminium (diameter <30mm), stainless steel (1,5-3mm).								
<b>2 PCS</b>	<b>JT118A HSS</b>	<b>METAL BASIC CUT</b>		1-3mm 3/64" - 1/8"	1,2mm	TPI 21		<b>GREAT VALUE</b>
Straight cuts on thin sheet metals, ferrous and non-ferrous materials (1-3mm).								
<b>2 PCS</b>	<b>JT118B HSS</b>	<b>METAL BASIC CUT</b>		2-6mm 1/8" - 1/4"	2mm	TPI 12		<b>GREAT VALUE</b>
Straight cuts on medium-thick metals, ferrous and non-ferrous materials (2,5-6mm).								
<b>2 PCS</b>	<b>JT218A HSS</b>	<b>METAL BASIC CUT</b>		1-3mm 1/16" - 1/8"	1,2mm	TPI 21		<b>GREAT VALUE</b>
Curve cuts on thin sheet metals, ferrous and non-ferrous (1-3mm).								

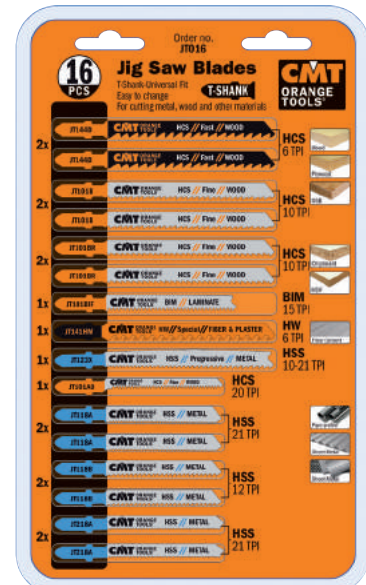

An assortment of 16 Jig Saw Blades featuring the 10 most popular blades for a variety of cutting needs:

- wood and timber (straight, curve cuts, course cutting and finishing);
- plasterboard, fiber cement, fiberglass, epoxy resins, and panels such as Eternit®;
- metal and sheet metal both thick and thin;
- stainless steel;
- aluminium and plastics.



15 Sets in End-cap display (minimum order 15 sets)



# QUALITY MATERIALS FOR MAXIMUM PRODUCTIVITY

Produced by following state-of-the-art processes, using high-tech machines and premium quality raw materials, these sabre saw blades have been specifically designed to ensure maximum lifetime and performance in all materials.



## Geometry is important!

GROUND & TAPER  
GROUND TEETH



Easily cut construction wood, plywood, framing lumber and plastic.

MILLED & SIDE SET TEETH

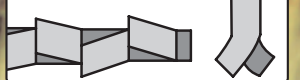

For quick cutting on hard/softwood, aluminium, plastic, ferrous and non-ferrous metal.

MILLED & WAVY SET TEETH



For fine, precise cuts in thin/thick metal, pipe, open and closed profiles.

**HCS** **High Carbon Steel**  
Great for cutting wood and plastic.

**BIM** **8% Co** **Bi-Metal with 8% Cobalt**  
Premium bi-metal with 8% Cobalt provides superb results and guarantees long life when cutting metal, plastic and wood with nails.

**HW** **Tungsten Carbide Tipped**  
Best for fiber cement board, brick and porous concrete.

### THE RIGHT BLADE FOR THE JOB!

Use our quick reference chart and pictograms to help you choose the best blade for your application.



**Non-Stick Orange Shield Coating**  
Keeps the blade running cool, reduces pitch build up and protects against corrosion. Ideal for all types of wood including wet lumber.

- Wood
- Wood & Metal
- Metal
- Special

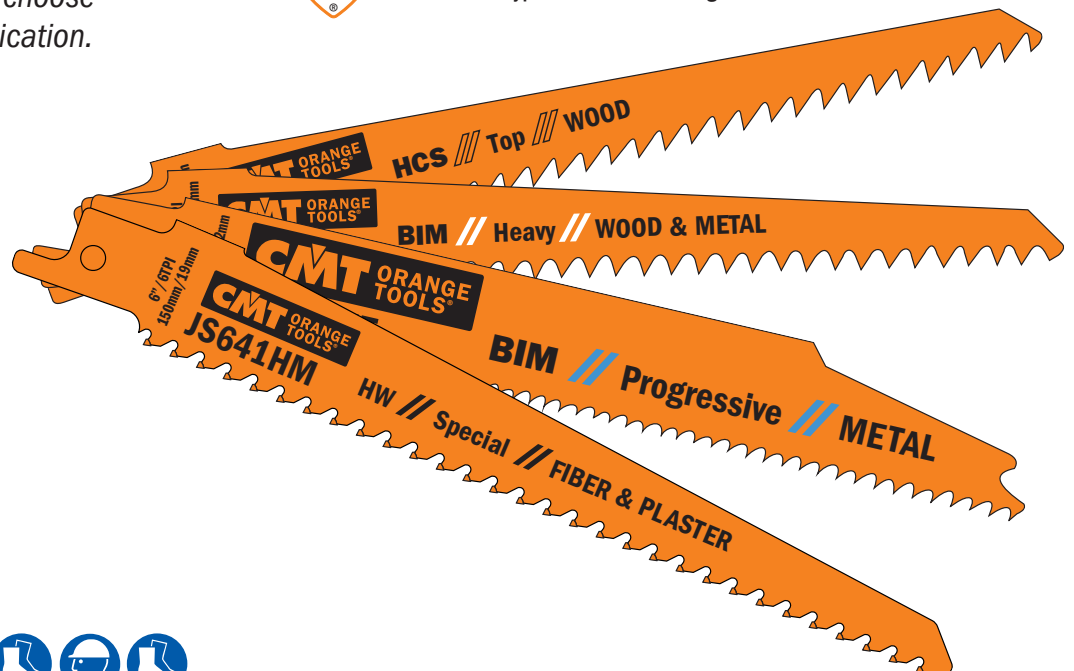



## JS032 32 piece Recip Saw Blades Set



7 PCS	KS644D HCS	WOOD	TPI 6 4.3mm	Curve	Nail-Free Coarse Wood	Wooden Wall Cutout	Boards	<100mm 4"	FINE CUT	
5 PCS	KS944D HCS	WOOD	TPI 6 4.3mm	Curve	Nail-Free Coarse Wood	Wooden Wall Cutout	Boards	<175mm 6-7/8"	FINE CUT	
5 PCS	KS611DF BIM	WOOD & NAILS	TPI 6 4.3mm	Wood with Nails	Boards	Plasterboard	Epoxy	<100mm 4"	LONG LIFE	
5 PCS	KS925VF BIM	METAL	TPI 10 2.5mm	Fine Straight	Sheet Metal	Pipes, Profiles	<100mm	<2.10mm 5/64"-25/64"	LONG LIFE	
5 PCS	KS922BF BIM	METAL	TPI 14 1.8mm	Fine Straight	Sheet Metal	Pipes, Profiles	<100mm	<3.9mm 1/8"-5/16"	LONG LIFE FAST CUT	
5 PCS	KS922EF BIM	METAL	TPI 18 1.4mm	Fine Straight	Sheet Metal	Pipes	Pipes, Profiles	<100mm	<1.5-4mm 1/16"-5/32"	LONG LIFE

CMT has chosen the 6 most popular Recip Saw Blades for our 32-piece set

This set includes recip saw blades for:

- Construction wood, wooden wall, boards like chipboard and MDF, plywood and timber products
- Wood with nails/metal, plastic profile, glass fiber reinforced plastic/epoxy, window frames
- Plasterboard, fiber cement, fiberglass, epoxy resins and Eternit®
- Metal and sheet-metal, both thick and thin
- Aluminium and plastics

Purchase this set to satisfy a variety of needs











10 Sets in End-cap display  
(minimum order 10 sets)

# Sabre Saw Blades Application Chart

Series	Material	Material Thickness  mm	Line	L	Fine Straight 	Coarse Straight 	Curve 	Fine Angle Cut 	Flush Cut 	Thin & Thick 	Demolition 	TPI	Page	
<b>WOOD</b>	<b>Coarse wood (free of nails)</b>	<100	Basic			<b>JS617K</b>	<b>JS617K</b>					3	62	
	<b>Pruning green wood</b>	<175	Basic			<b>JS1111K</b>						3	62	
	Coolant: dry	<190	Top			<b>JS1531L</b>						5	62	
	MAX RPM 2500	<250	Basic			<b>JS1617K</b>						3	62	
	<b>Construction wood</b>	<100	Top	150	<b>JS644D</b>		<b>JS644D</b>						6	62
	Coolant: dry	<150	Progressive	200	<b>JS2345X</b>					<b>JS2345X</b>			6-10	63
	MAX RPM 2500	<150	Pallet	200	<b>JS725VFR</b>			<b>JS725VFR</b>		<b>JS725VFR</b>	<b>JS725VFR</b>		8-12	63
	<b>Boards</b>	<60	Top	150	<b>JS644D</b>		<b>JS644D</b>						6	62
	Coolant: dry	<60	Progressive	200	<b>JS2345X</b>					<b>JS2345X</b>			6-10	63
	MAX RPM 2500	<60	Pallet	200	<b>JS725VFR</b>			<b>JS725VFR</b>		<b>JS725VFR</b>			8-12	63
	<b>Wooden wall cutout</b>	<100	Top	150	<b>JS644D</b>		<b>JS644D</b>						6	62
	Coolant: dry	<150	Progressive	200	<b>JS2345X</b>					<b>JS2345X</b>			6-10	63
	MAX RPM 2500	<150	Pallet	200	<b>JS725VFR</b>			<b>JS725VFR</b>		<b>JS725VFR</b>	<b>JS725VFR</b>		8-12	63
		<190	Top	240		<b>JS1531L</b>							5	62
	<b>Plastic</b>	<100	Top	150	<b>JS644D</b>		<b>JS644D</b>						6	62
	Coolant: water MAX RPM 500	<150	Progressive	200	<b>JS2345X</b>					<b>JS2345X</b>			6-10	63
<b>WOOD &amp; METAL</b>	<b>Wood with nails/metal</b>	<100	Flexible	150	<b>JS922HF</b>							10	63	
	Coolant: dry	<100	Flexible	150	<b>JS922VF</b>							10-14	64	
	MAX RPM 2500	<100	Heavy	150	<b>JS641HM</b>	<b>JS611DF</b>	<b>JS711DF</b>					6	64, 66	
		<100	Heavy	150		<b>JS610VF</b>		<b>JS610VF</b>			<b>JS610VF</b>		5-8	65
		<150	Progressive	200		<b>JS3456XF</b>				<b>JS3456XF</b>			6-12	63
		<150	Pallet	200	<b>JS725VFR</b>			<b>JS725VFR</b>		<b>JS725VFR</b>	<b>JS725VFR</b>		8-12	63
		<175	Flexible	225	<b>JS1122HF</b>				<b>JS1122HF</b>				10	63
		<175	Flexible	225	<b>JS1122VF</b>				<b>JS1122HF</b>				10-14	63-64
		<175	Heavy	225		<b>JS1111DF</b>							6	65
		<175	Heavy	225		<b>JS1110VF</b>		<b>JS1110VF</b>			<b>JS1110VF</b>		5-8	65
		<250	Flexible	300	<b>JS1222VF</b>				<b>JS1222VF</b>				10-14	64
		<250	Heavy	300		<b>JS1210VF</b>		<b>JS1210VF</b>			<b>JS1210VF</b>		5-8	65
		<250	Heavy	300		<b>JS1411DF</b>							6	65
	<b>Pallet</b>	<100	Flexible	150	<b>JS922HF</b>	<b>JS641HM</b>							10	63, 66
	Coolant: dry	<150	Pallet	200	<b>JS725VFR</b>			<b>JS725VFR</b>		<b>JS725VFR</b>	<b>JS725VFR</b>		8-12	63
	MAX RPM 2500	<175	Flexible	225	<b>JS1122HF</b>				<b>JS1122HF</b>				10	63
	<b>Wood, chipboard</b>	<100	Heavy	150		<b>JS611DF</b>	<b>JS711DF</b>						6	64
	Coolant: dry	<100	Heavy	150		<b>JS610VF</b>		<b>JS610VF</b>			<b>JS610VF</b>		5-8	65
	MAX RPM 2500	<150	Progressive	200		<b>JS3456XF</b>				<b>JS3456XF</b>			6-12	63
		<150	Pallet	200	<b>JS725VFR</b>			<b>JS725VFR</b>		<b>JS725VFR</b>	<b>JS725VFR</b>		8-12	63
		<175	Heavy	225		<b>JS1111DF</b>							6	65
		<175	Heavy	225		<b>JS1110VF</b>		<b>JS1110VF</b>			<b>JS1110VF</b>		5-8	65
		<250	Heavy	300		<b>JS1210VF</b>		<b>JS1210VF</b>			<b>JS1210VF</b>		5-8	65
		<250	Heavy	300		<b>JS1411DF</b>							6	65
	<b>Sheet metals</b>	3~10	Flexible	150	<b>JS922VF</b>								10-14	64
	Coolant: cutting oil	3~10	Flexible	225	<b>JS1122VF</b>				<b>JS1122HF</b>				10-14	63-64
	MAX RPM 500~2000	3~10	Flexible	300	<b>JS1222VF</b>				<b>JS1222HF</b>				10-14	63-64
		3~18	Progressive	200		<b>JS3456XF</b>				<b>JS3456XF</b>			6-12	63
	<b>Pipes, profiles</b>	<100	Flexible	150	<b>JS922VF</b>								10-14	64
	Coolant: cutting oil	<150	Progressive	200		<b>JS3456XF</b>				<b>JS3456XF</b>			6-12	63
	MAX RPM 1500	<175	Flexible	225	<b>JS1122VF</b>				<b>JS1122HF</b>				10-14	63-64
		<250	Flexible	300	<b>JS1222VF</b>				<b>JS1222VF</b>				10-14	64
<b>Plastic, pipes, profiles</b>	<100	Heavy	150		<b>JS611DF</b>	<b>JS711DF</b>						6	64	
Coolant: water	<150	Progressive	200		<b>JS3456XF</b>				<b>JS3456XF</b>			6-12	63	
MAX RPM 500	<175	Heavy	225		<b>JS1111DF</b>							6	65	
	<250	Heavy	300		<b>JS1411DF</b>							6	65	
<b>Glass fiber reinforced plastic/epoxy</b>	<50	Heavy	150		<b>JS611DF</b>	<b>JS711DF</b>						6	64	
Coolant: water	<60	Heavy	300		<b>JS1411DF</b>							6	65	
MAX RPM 500	<60	Heavy	150		<b>JS610VF</b>		<b>JS610VF</b>			<b>JS610VF</b>		5-8	65	
	<60	Heavy	225		<b>JS1111DF</b>							6	65	
	<60	Heavy	225		<b>JS1110VF</b>		<b>JS1110VF</b>			<b>JS1110VF</b>		5-8	65	
	<100	Flexible	150	<b>JS922VF</b>	<b>JS641HM</b>							10-14	64, 66	
	<150	Progressive	200		<b>JS3456XF</b>				<b>JS3456XF</b>			6-12	63	
	<175	Flexible	225	<b>JS1122VF</b>				<b>JS1122HF</b>				10-14	63-64	
	<250	Flexible	300	<b>JS1222VF</b>				<b>JS1222VF</b>				10-14	64	
	<250	Heavy	300		<b>JS1210VF</b>		<b>JS1210VF</b>			<b>JS1210VF</b>		5-8	65	

**TIP:** Using a lubricant can extend blade lifetime up to 500%.

Series	Material	Material Thickness  mm	Line	L	Fine Straight 	Coarse Straight 	Curve 	Fine Angle Cut 	Flush Cut 	Thin & Thick 	Demolition 	TPI	Page	
<b>METAL</b>	Sheet, perforated metals, (thin & thick) Coolant: cutting oil MAX RPM 500~2000	0,7~3	Flexible	150	JS922AF							24	66	
		0,7~3	Flexible	225	JS1122AF				JS1122AF			24	66	
		1~8	Progressive	150	JS123XF						JS123XF		8~14	66
		1,5~4	Flexible	150	JS922EF								18	66
		1,5~4	Flexible	225	JS1122EF					JS1122EF			18	66
		2~10	Heavy	150	JS925VF							JS925VF	10~14	67
		2~10	Heavy	200	JS1025VF							JS1025VF	10~14	67
		2~10	Heavy	225	JS1125VF							JS1125VF	10~14	67
		2~10	Heavy	300	JS1125VF							JS1125VF	10~14	67
		3~8	Flexible	150	JS922BF								14	67
	3~8	Flexible	225	JS1122BF					JS1122BF			14	67	
	4~12	Heavy	150			JS920CF		JS920CF				9	68	
	4~12	Heavy	225			JS1120CF		JS1120CF				9	68	
	Pipes, profiles, thin-walled (open & closed) Coolant: cutting oil MAX RPM 500~2000	<100	Flexible	150	JS922AF								24	66
		<100	Flexible	150	JS922EF								18	66
		<100	Progressive	150	JS123XF						JS123XF		8~14	66
		<100	Heavy	150	JS925VF							JS925VF	10~14	67
		<150	Heavy	200	JS1025VF							JS1025VF	10~14	67
		<175	Flexible	225	JS1122AF					JS1122AF			24	66
		<175	Flexible	225	JS1122EF					JS1122EF			18	66
		<175	Heavy	225	JS1125VF							JS1125VF	10~14	67
		<250	Heavy	300	JS1225VF							JS1225VF	10~14	67
		Pipes, profiles, thick-walled (open & closed) Coolant: cutting oil MAX RPM 500~2000	<100	Flexible	150	JS922BF								14
	<100		Progressive	150	JS123XF						JS123XF		8~14	66
	<100		Heavy	150	JS925VF							JS925VF	10~14	67
	<100		Heavy	150			JS920CF		JS920CF			JS920CF	9	68
	<150		Heavy	200	JS1025VF							JS1025VF	10~14	67
	<175		Flexible	225	JS1122BF					JS1122BF			14	67
<175	Heavy		225	JS1125VF							JS1125VF	10~14	67	
<175	Heavy		225			JS1120CF		JS1120CF			JS1120CF	9	68	
Pipes, profiles (solid) Coolant: cutting oil MAX RPM 500~2000	<100	Progressive	150	JS123XF						JS123XF		8~14	66	
	<100	Flexible	150	JS922BF								14	67	
	<100	Heavy	150			JS920CF		JS920CF			JS920CF	9	68	
	<175	Flexible	225	JS1122BF						JS1122BF		14	67	
	<175	Heavy	225			JS1120CF		JS1120CF			JS1120CF	9	68	
<b>SPECIAL</b>	Plasterboard	<100	Heavy	150	JS641HM	JS611DF	JS711DF					6	64-66	
	Fiber Cement panels	<215	Special	305		JS1243HM		JS1243HM				2	68	
		<365	Special	455		JS2243HM		JS2243HM				2	68	
	Porous concrete, red brick	<215	Special	305		JS1243HM		JS1243HM				2	68	
<365		Special	455		JS2243HM		JS2243HM				2	68		

**Tip:** Using a lubricant can extend blade lifetime up to 500%.

## BLADE LINE DESCRIPTIONS

Different lines help you choose the right blade for the task at hand.

- BASIC:** Cost effective
- FLEXIBLE:** Breakproof, long lifetime
- PROGRESSIVE:** Fast cutting through thin and thick material
- TOP:** Fast and efficient
- HEAVY:** Sturdy and precise

## 12,7MM (1/2") UNIVERSAL SHANK

Fits: AEG, B&D, Bosch, DeWalt, Fein, Flex, Hilti, Makita, Metabo, Milwaukee, Porter Cable, Ridgid, Rothenberger, Ryobi, Skil.

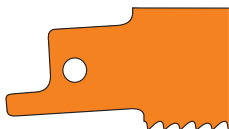

## BLADES SHAPES & THICKNESS

Sabre Saw Blades vary in shape and thickness. These two characteristics are adjusted according to the demands of the application as well as the required flexibility. Rigorous applications such as cutting tube and pipe require thick robust blades, while less demanding applications require narrower blades.

Blade shapes are divided into three categories below:

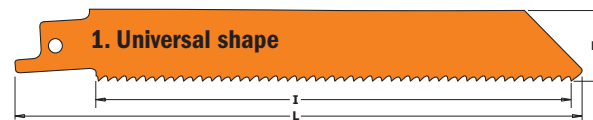

Universal blades are for general use. Their even width guarantees good cutting stability and excellent control. This enables straight edge cutting through many different materials.

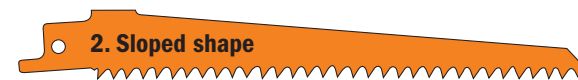

Sloped blades are commonly used for cutting wood and for demolition applications. Their narrow tip allows for plunge and curve cutting. This shape is rarely used for metal, since the tip does not have the strength required for this application.



Scroll blades are especially used for curve cutting. The narrower the blade, the smaller the radius it can cut.



# Sabre Saw Blades

## JS617K

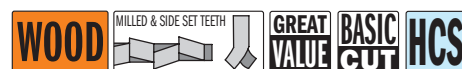

PACK Quantity	L mm	I mm	H mm	K mm	TS mm	TPI		ORDER NO. Universal Shank
5	150	130	19	1,25	8,5	3	10	<b>JS617K-5</b>



Cuts coarse wood, free of nails (<100mm), pruning green wood (diameter <100mm), excellent for curved and plunge cutting.

## JS1111K



PACK Quantity	L mm	I mm	H mm	K mm	TS mm	TPI		ORDER NO. Universal Shank
5	225	205	19	1,25	8,5	3	10	<b>JS1111K-5</b>



Coarse wood, free of nails (<175mm), firewood (diameter <175mm).

## JS1617K

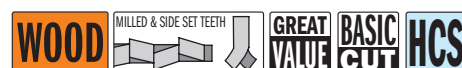

PACK Quantity	L mm	I mm	H mm	K mm	TS mm	TPI		ORDER NO. Universal Shank
5	300	280	19	1,25	8,5	3	10	<b>JS1617K-5</b>



Coarse wood, free of nails (<250mm), pruning green wood (diameter <250mm).

## JS644D

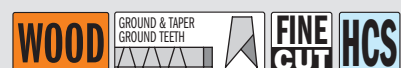

PACK Quantity	L mm	I mm	H mm	K mm	TS mm	TPI		ORDER NO. Universal Shank
5	150	130	19	1,25	4,3	6	10	<b>JS644D-5</b>

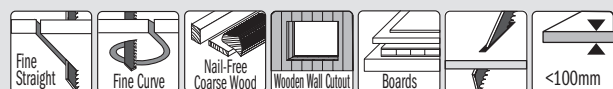

Cuts construction wood (<100mm), wooden wall panels, particle board, chipboard, MDF (6-60mm), plywood, plastic (<100mm). Excellent for plunge cutting

## JS1531L

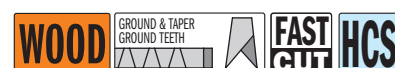

PACK Quantity	L mm	I mm	H mm	K mm	TS mm	TPI		ORDER NO. Universal Shank
5	240	220	19	1,50	5	5	10	<b>JS1531L-5</b>



Coarse wood, free of nails (<190mm), pruning green wood (diameter <190mm), firewood (diameter <190mm).

# Sabre Saw Blades



## JS2345X



PACK Quantity	L mm	I mm	H mm	K mm	TS mm	TPI		ORDER NO. Universal Shank
5	200	180	19	1,25	2,4-4	6-10	10	<b>JS2345X-5</b>



Cuts construction wood (<150mm), particle board: chipboard, MDF (6-60mm), plywood, plastic (<150mm), wooden wall (<150mm). Effortless fine cutting.

## JS922HF

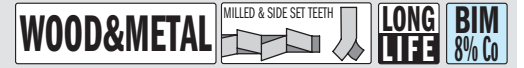

PACK Quantity	L mm	I mm	H mm	K mm	TS mm	TPI		ORDER NO. Universal Shank
5	150	130	19	0,90	2,5	10	10	<b>JS922HF-5</b>



For pallet repair, wood with nails/metal (<100mm), sheet metal, pipe, aluminium profiles (3-12mm).

## JS1122HF

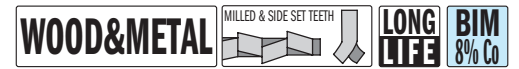

PACK Quantity	L mm	I mm	H mm	K mm	TS mm	TPI		ORDER NO. Universal Shank
5	225	205	19	0,90	2,5	10	10	<b>JS1122HF-5</b>
20	225	205	19	0,90	2,5	10	5	<b>JS1122HF-20</b>

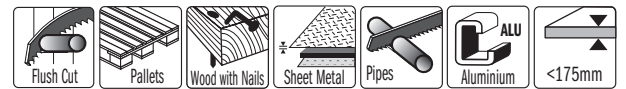

For pallet repair, wood with nails/metal (<175mm), sheet metal, pipe, aluminium profiles (3-12mm). Flexible flush cutting.

## JS3456XF



PACK Quantity	L mm	I mm	H mm	K mm	TS mm	TPI		ORDER NO. Universal Shank
5	200	180	19	1,25	2,1-4,3	6-12	10	<b>JS3456XF-5</b>
20	200	180	19	1,25	2,1-4,3	6-12	5	<b>JS3456XF-20</b>

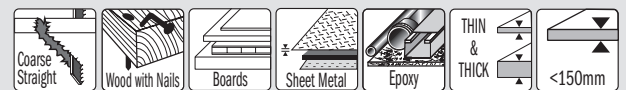

For cutting wood with nails or metal, chipboard less than 150mm (6") in thickness, sheet metal, aluminium profiles from 3mm to 18mm (1/8" - 3/4") in thickness, glass fiber reinforced plastic/epoxy less than 150mm (6") in thickness.

## JS725VFR

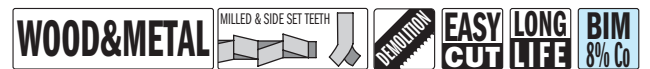

PACK Quantity	L mm	I mm	H mm	K mm	TS mm	TPI		ORDER NO. Universal Shank
5	200	180	19	1,27	2,1-3,2	8-12	10	<b>JS725VFR-5</b>
20	200	180	19	1,27	2,1-3,2	8-12	5	<b>JS725VFR-20</b>



Special saw blade for pallet repairs. Cutting depth 150mm. Optimized saw blade dimensions for low vibration.

## JS922VF



**WOOD&METAL** MILLED & SIDE SET TEETH **EASY CUT** **LONG LIFE** **BIM 8% Co**

Pack Quantity	L mm	I mm	H mm	K mm	TS mm	TPI		ORDER NO. Universal Shank
5	150	130	19	0,90	1,8-2,6	10-14	10	<b>JS922VF-5</b>

Fine Straight Wood with Nails Sheet Metal Pipes Aluminium Epoxy <100mm

Cuts wood with nails/metal (<100mm), sheet metal, pipe, aluminium profiles (3-10mm), glass fiber reinforced plastic/epoxy (<100mm).

## JS1122VF



**WOOD&METAL** MILLED & SIDE SET TEETH **EASY CUT** **LONG LIFE** **BIM 8% Co**

Pack Quantity	L mm	I mm	H mm	K mm	TS mm	TPI		ORDER NO. Universal Shank
5	225	205	19	0,90	1,8-2,6	10-14	10	<b>JS1122VF-5</b>

Flush Cut Wood with Nails Sheet Metal Pipes Aluminium Epoxy <175mm

Cuts wood with nails/metal (<175mm), sheet metal, aluminium profiles (3-10mm), glass fiber reinforced plastic/epoxy (<175mm). Flexible flush cutting.

## JS1222VF



**WOOD&METAL** MILLED & SIDE SET TEETH **EASY CUT** **LONG LIFE** **BIM 8% Co**

Pack Quantity	L mm	I mm	H mm	K mm	TS mm	TPI		ORDER NO. Universal Shank
5	300	280	19	0,90	1,8-2,6	10-14	10	<b>JS1222VF-5</b>

Flush Cut Wood with Nails Sheet Metal Pipes Aluminium Epoxy <250mm

Cuts wood with nails/metal (<250mm), sheet metal, aluminium profiles (3-10mm), glass fiber reinforced plastic/epoxy (<250mm). Flexible flush cutting.

## JS611DF



**WOOD&METAL** MILLED & SIDE SET TEETH **EASY CUT** **LONG LIFE** **BIM 8% Co**

Pack Quantity	L mm	I mm	H mm	K mm	TS mm	TPI		ORDER NO. Universal Shank
5	150	130	19	1,25	4,3	6	10	<b>JS611DF-5</b>

Coarse Straight Wood with Nails Boards Plasterboard Epoxy <100mm

Cuts wood with nails/metal, chipboard (<100mm), plastic profiles (<100mm), glass fiber reinforced plastic/epoxy (<50mm), wood and metal window frames plasterboard. Excellent for plunge cutting.

## JS711DF

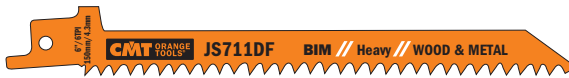

**WOOD&METAL** MILLED & SIDE SET TEETH **EASY CUT** **LONG LIFE** **BIM 8% Co**

Pack Quantity	L mm	I mm	H mm	K mm	TS mm	TPI		ORDER NO. Universal Shank
5	150	130	12	1,25	4,3	6	10	<b>JS711DF-5</b>

Fine Curve Wood with Nails Boards Plasterboard Epoxy <100mm

Cuts wood with nails/metal, chipboard (<100mm), glass fiber reinforced plastic/epoxy (<50mm), plasterboard. Excellent for curved cuts.



## JS1111DF

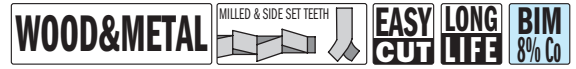

PACK Quantity	L mm	I mm	H mm	K mm	TS mm	TPI		ORDER NO. Universal Shank
5	225	205	19	1,25	4,3	6	10	<b>JS1111DF-5</b>
20	225	205	19	1,25	4,3	6	5	<b>JS1111DF-20</b>



For cutting wood with nails or metal, chipboard less than 175mm (7") in thickness, plastic profiles less than 175mm in diameter (7") in diameter, glass fiber reinforced plastic/epoxy less than 50mm (2") in thickness.

## JS1411DF

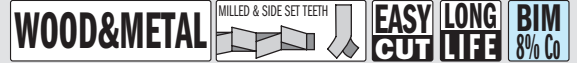

PACK Quantity	L mm	I mm	H mm	K mm	TS mm	TPI		ORDER NO. Universal Shank
5	300	280	19	1,25	4,3	6	10	<b>JS1411DF-5</b>

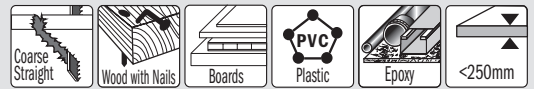

Cuts wood with nails/metal, chipboard (<250mm), glass fiber reinforced plastic/epoxy (<60mm).

## JS610VF

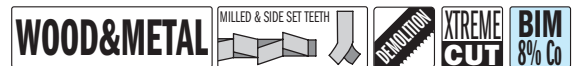

PACK Quantity	L mm	I mm	H mm	K mm	TS mm	TPI		ORDER NO. Universal Shank
5	150	130	22	1,60	3,2-5	5-8	10	<b>JS610VF-5</b>

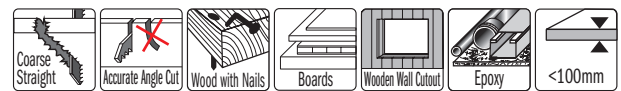

Cuts wood with nails/metal, wood, chipboard (<100mm), glass fiber reinforced plastic/epoxy and solid (<100mm), wood and metal wall cut-outs, (<100mm). Excellent for rescue/demolition work.

## JS1110VF

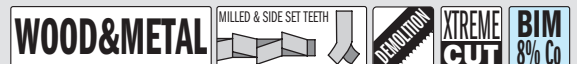

PACK Quantity	L mm	I mm	H mm	K mm	TS mm	TPI		ORDER NO. Universal Shank
5	225	205	22	1,60	3,2-5	5-8	10	<b>JS1110VF-5</b>
20	225	205	22	1,60	3,2-5	5-8	5	<b>JS1110VF-20</b>



For cutting wood with nails or metal, chipboard, glass fiber reinforced with solid plastic epoxy, wooden and metal wall cutouts with less than 175mm (7") in thickness. For rescue and demolition work.

## JS1210VF



PACK Quantity	L mm	I mm	H mm	K mm	TS mm	TPI		ORDER NO. Universal Shank
5	300	280	22	1,60	3,2-5	5-8	10	<b>JS1210VF-5</b>

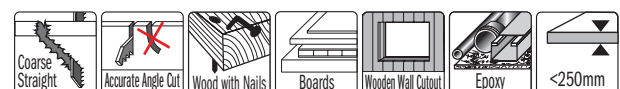

Cuts wood with nails/metal, wood, chipboard (<250mm), glass fiber reinforced plastic/epoxy (<250mm), wood and metal wall cut-outs less than (<250mm). Excellent for rescue/demolition work.

## JS641HM

**SPECIAL EASY CUT FINE CUT EXTRA LONG LIFE HW**



Pack Quantity	L mm	I mm	H mm	K mm	TS mm	TPI		ORDER NO. Universal Shank
2	150	130	19	1,25	4,3	6	25	<b>JS641HM-2</b>



Cuts porous concrete, red brick, fiber cement, plasterboard, glass fiber reinforced plastic/epoxy (<100mm), wood & nails, Eternit®, MDF.

## JS922AF



**METAL** MILLED & WAVY SET TEETH **EASY CUT FINE CUT LONG LIFE BIM 8% Co**

Pack Quantity	L mm	I mm	H mm	K mm	TS mm	TPI		ORDER NO. Universal Shank
5	150	130	19	0,90	1	24	10	<b>JS922AF-5</b>



Cuts thin sheet metal (0,7-3mm), fine pipe and profiles (diameter <100mm). Effortless fine cuts.

## JS1122AF



**METAL** MILLED & WAVY SET TEETH **EASY CUT FINE CUT LONG LIFE BIM 8% Co**

Pack Quantity	L mm	I mm	H mm	K mm	TS mm	TPI		ORDER NO. Universal Shank
5	225	205	19	0,90	1	24	10	<b>JS1122AF-5</b>



Cuts thin sheet metal (0,7-3mm), fine pipe and profiles (diameter <175mm). Effortless fine cuts.

## JS922EF



**METAL** MILLED & WAVY SET TEETH **LONG LIFE BIM 8% Co**

Pack Quantity	L mm	I mm	H mm	K mm	TS mm	TPI		ORDER NO. Universal Shank
5	150	130	19	0,90	1,4	18	10	<b>JS922EF-5</b>
20	150	130	19	0,90	1,4	18	5	<b>JS922EF-20</b>



Cuts thin sheet metal (1,5-4mm), pipe and profiles (diameter <100mm).

## JS1122EF



**METAL** MILLED & WAVY SET TEETH **LONG LIFE BIM 8% Co**

Pack Quantity	L mm	I mm	H mm	K mm	TS mm	TPI		ORDER NO. Universal Shank
5	225	205	19	0,90	1,4	18	10	<b>JS1122EF-5</b>
20	225	205	19	0,90	1,4	18	5	<b>JS1122EF-20</b>



Cuts thin sheet metal (1,5-4mm), pipe and profiles (diameter <175mm). Flexible flush cuts.

## JS123XF



**METAL** MILLED & SIDE SET TEETH **LONG LIFE FAST CUT BIM 8% Co**

Pack Quantity	L mm	I mm	H mm	K mm	TS mm	TPI		ORDER NO. Universal Shank
5	150	130	19	0,90	1,8-3,2	8-14	10	<b>JS123XF-5</b>

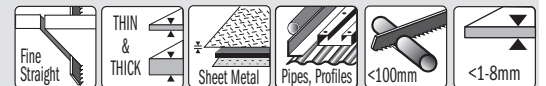

Cuts thin to thick sheet metal (1-8mm) and thin to thick profiles (diameter <100mm).

## JS922BF



PACK Quantity	L mm	I mm	H mm	K mm	TS mm	TPI		ORDER NO. Universal Shank
5	150	130	19	0,90	1,8	14	10	<b>JS922BF-5</b>
20	150	130	19	0,90	1,8	14	5	<b>JS922BF-20</b>

Cuts thick sheet metal (3-8mm), solid pipe and profiles (diameter <100mm). Quick cutting.



## JS1122BF



PACK Quantity	L mm	I mm	H mm	K mm	TS mm	TPI		ORDER NO. Universal Shank
5	225	205	19	0,90	1,8	14	10	<b>JS1122BF-5</b>
20	225	205	19	0,90	1,8	14	5	<b>JS1122BF-20</b>

Cuts thick sheet metal (3-8mm), solid pipe and profiles (diameter <175mm). Flexible flush cuts and quick cutting.



## JS925VF



PACK Quantity	L mm	I mm	H mm	K mm	TS mm	TPI		ORDER NO. Universal Shank
5	150	130	19	1,25	1,8-2,6	10-14	10	<b>JS925VF-5</b>

Cuts medium-thick to thick sheet metal (2-10mm), thin and thick-walled pipe and profiles (<100mm). Ideal for demolition work in metal. Effortless, fine cutting.



## JS1025VF

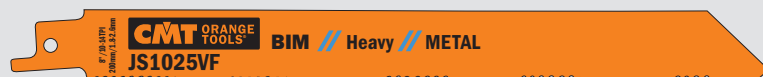

PACK Quantity	L mm	I mm	H mm	K mm	TS mm	TPI		ORDER NO. Universal Shank
5	200	180	19	1,25	1,8-2,6	10-14	10	<b>JS1025VF-5</b>

Cuts medium-thick to thick sheet metal (2-10mm), thin and thick-walled pipe and profiles (<150mm). Ideal for demolition work in metal. Effortless, fine cutting.



## JS1125VF



PACK Quantity	L mm	I mm	H mm	K mm	TS mm	TPI		ORDER NO. Universal Shank
5	225	205	19	1,25	1,8-2,6	10-14	10	<b>JS1125VF-5</b>

Cuts medium-thick to thick sheet metal (2-10mm), thin and thick-walled pipe and profiles (<175mm). Ideal for demolition work in metal. Effortless, fine cutting.



## JS1225VF



PACK Quantity	L mm	I mm	H mm	K mm	TS mm	TPI		ORDER NO. Universal Shank
5	300	280	19	1,25	1,8-2,6	10-14	10	<b>JS1225VF-5</b>

Cuts medium-thick to thick sheet metal (2-10mm), thin and thick-walled pipe and profiles (<250mm). Ideal for demolition work in metal. Effortless, fine cutting.





# Sabre Saw Blades



## JS920CF



PACK Quantity	L mm	I mm	H mm	K mm	TS mm	TPI		ORDER NO.
5	150	130	22	1,60	2,9	9	10	<b>JS920CF-5</b>



Cuts thick sheet metal (4-12mm), thick-walled pipe, solid pipe and profiles (<100mm). Ideal for pipe cutting, for rescue/demolition work. Powerful, coarse cutting.

## JS1120CF



PACK Quantity	L mm	I mm	H mm	K mm	TS mm	TPI		ORDER NO.
5	225	205	22	1,60	2,9	9	10	<b>JS1120CF-5</b>
20	225	205	22	1,60	2,9	9	5	<b>JS1120CF-20</b>

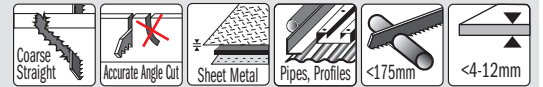

For cutting thick sheet metal from 4mm to 12mm (5/32" - 1/2") in thickness, thick-walled solid pipe and profiles less than 175mm (7") in thickness. Ideal for pipe cutters, for rescue and demolition work. Powerful coarse cut.

## JS1243HM



PACK Quantity	L mm	I mm	H mm	K mm	TS mm	TPI		ORDER NO.
1	305	250	50	1,50	12,7	2	25	<b>JS1243HM</b>

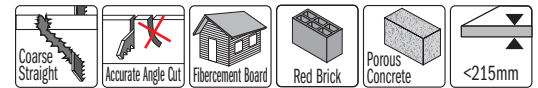

Cuts medium-sized brick up to a material thickness of 215mm.

## JS2243HM



PACK Quantity	L mm	I mm	H mm	K mm	TS mm	TPI		ORDER NO.
1	455	400	50	1,50	12,7	2	25	<b>JS2243HM</b>

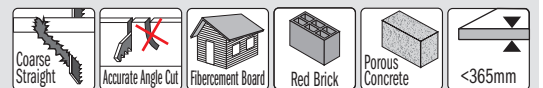

Cuts large brick up to 365mm in thickness.



# TOOLS FOR MULTI-CUTTERS

PRODUCTS	PAGE
<b>Starlock/StarlockPlus/StarlockMax Arbors</b>	
Radial Saw Blade	73
Plunge and Flush-Cut for Wood	74~76
Plunge and Flush-Cut for Wood & Nails	76-77
Blade for Wood & Metal	78
Blade for Metal	78
Radial Saw Blade for Masonry	79-80
Rasp for Masonry	80
Scraper for all Materials	81
Blade for Special Material	82
Multipurpose set for Oscillating Multi-Tools	82
Polishing Fleece	83
Sandpaper & Accessory for Wood	83

## Universal/SuperCut Arbors

Plunge and Flush-Cut for Wood	85-86
Radial Saw Blade for Wood	87
Plunge and Flush-Cut for Wood & Metal	87~89
Radial Saw Blade for Wood & Metal	89
Scraper for all Materials	90
Radial Saw Blade for Masonry	90~92
Rasp for Masonry	91-92
Grout and Mortar Remover for Masonry	92
Polishing Fleece	93
Sandpaper for Wood	93
Multipurpose set for Oscillating Multi-Tools	93-94

**CMT11**  
Oscillating Multi-Tools



355



## MAXIMIZING YOUR WORK PERFORMANCE

**HCS**

**HIGH CARBON STEEL**  
for cutting wood and plastic.

**BIM  
8% Co**

**BI-METAL WITH 8% COBALT**  
for cutting metal, nail embedded wood and plastic.

**BIM  
TiN**

**BI-METAL WITH 8% COBALT WITH TITANIUM COATING**  
for cutting metal, nail embedded wood and plastic, providing extreme performance and 30% longer lifetime.

**HW**

**TUNGSTEN CARBIDE TIPPED**  
for cutting wood, screws and nails, fiber cement board, plasterboard, plastic, sheet metal, copper, aluminium and stainless steel with double lifetime.

**CARBIDE  
GRIT**

**TUNGSTEN CARBIDE GRIT COATED**  
for routing joints and grooves, smaller cutouts, routing recesses in several materials, from tiles, plasterboard, porous concretes, construction materials, epoxy and glass fibre.

**DIAMOND  
GRIT**

**DIAMOND GRIT COATED**  
for routing joints and grooves, smaller cutouts, routing recesses in several materials, from tiles, plasterboard, porous concretes, construction materials, epoxy and glass fibre providing extreme performance and longer lifetime.



# SAWING & CUTTING





## SCRAPING & RASPING



## ROUTING & GRINDING



**MULTI MATERIALS**

## SANDING, CLEANING & POLISHING



**APPLICATIONS**

- GRINDING
- SAWING
- JOINT OPENING
- PLASTIC CUTTING
- CARPET REMOVAL
- PLUNGE CUTTING
- WOOD CUTTING
- CUTTING LAMINATE SHEETS
- TUBE LENGTH TRIMMING
- NAIL CUTTING

**THE RIGHT BLADE FOR THE BEST RESULTS!**

Quick reference charts and pictograms help you choose the right blade for your application.

**WOOD**

**WOOD&NAILS**  
**WOOD&METAL**

**METAL**

**MULTI-MAT**

**MASONRY**

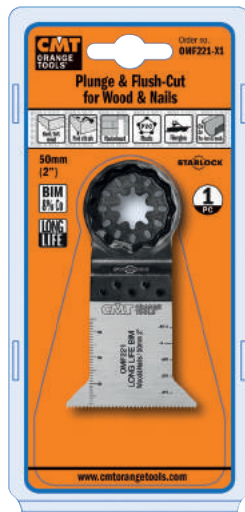

**STARLOCK: THE NEW SYSTEM FOR OSCILLATING POWER TOOLS**

Starlock enables extremely reliable and fast accessory changes in a record time of less than 3 seconds. It also guarantees a secure fit and therefore maximum power transfer. The result: up to around 35% faster performance depending on the accessory, noticeably improved precision and reduced noise. To protect the individual tools from overload and damage, the system is divided into 3 performance classes: **Starlock**, **StarlockPlus** and **StarlockMax**.

The performance potential of an oscillating tool can only be fully exploited with the right accessories.

The exceptional quality and service life of our accessories combined with the perfect results delivers excellent value for money.

WHICH POWER TOOLS ARE THE BLADES COMPATIBLES WITH?	STARLOCK	STARLOCK PLUS	STARLOCK MAX
	SL	SLP	SLM
AEG	●		
Bosch	●	●	●
CMT	●		
Craftsman	●	●	
Dewalt	●		
Dremel	●		
Einhell	●		
Fein Multi Talent/Multi Master	●	●	
Fein Supercut Automotive/Construction	●	●	●
Festool Vecturo	●	●	●
Hitachi	●		
Makita	●	●	
Metabo	●		
Milwaukee	●	●	
Ridgid	●		
Rockwell	●	●	
Ryoby	●	●	
Skil	●	●	
Worx	●		

Some brands may require an adapter



## OMF113 STARLOCK

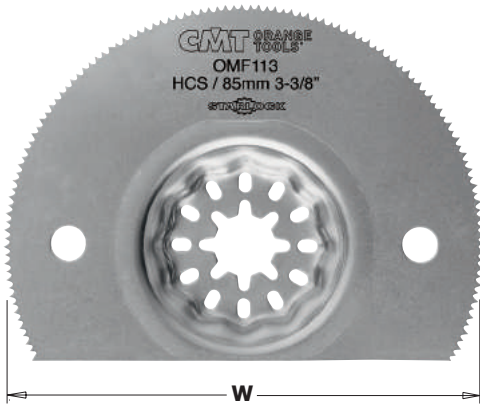

### 85mm Radial Saw Blade for Soft Materials

- FEATURES:** HCS with hardened teeth.  
**MATERIAL:** Soft materials only.  
**APPLICATION:** Segmented, ideal for corners, edges, flush to the surface. Prevents overcutting.

### MULTI-MAT HCS

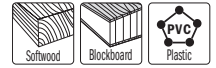

Pack Quantity	W mm	K mm	TS mm	TPI		ORDER NO. Starlock
1 in clamshell	85	0,8	1,5	17	1	<b>OMF113-X1</b>
5 in clamshell	85	0,8	1,5	17	1	<b>OMF113-X5</b>

## OMF106 STARLOCK

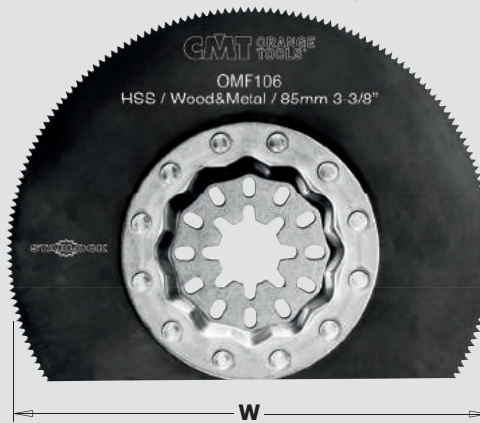

### 85mm Radial Saw Blade for Metal & Wood

- FEATURES:** HSS with metal tooting.  
**MATERIAL:** For sheet metal up to 2mm, plastic, GFRP, wood, parquet flooring, glazing compound, brass, bronze and fiberglass.  
**APPLICATION:** clean narrow cutting lines, excellent for corner work, flush to the surface.

### WOOD&METAL HSS



Pack Quantity	W mm	K mm	TS mm	TPI		ORDER NO. Starlock
1 in clamshell	85	0,5	1,34	19	1	<b>OMF106-X1</b>
5 in clamshell	85	0,5	1,34	19	1	<b>OMF106-X5</b>

## OMF174 STARLOCK



### 85mm Circular Saw Blade for Metal & Wood. Long Life

- FEATURES:** Reinforced teeth with Bi-metal 8% cobalt for long life.  
**MATERIAL:** For sheet metal up to 2mm, plastics, fiberglass, GFRP, wood, glazing compound, brass, bronze.  
**APPLICATION:** Work flush to the surface, circular shape for increased cost-effectiveness.

### WOOD&METAL BIM 8% Co



Pack Quantity	W mm	K mm	TS mm	TPI		ORDER NO. Starlock
1 in clamshell	85	0,7	1,27	20	1	<b>OMF174-X1</b>
5 in clamshell	85	0,7	1,27	20	1	<b>OMF174-X5</b>



**OMF133 STARLOCK**



**35mm Plunge and Flush-Cut for Wood**

- FEATURES:** HCS with hardened teeth.
- MATERIAL:** For all wood products up to 50mm, plasterboard and soft plastics.
- APPLICATION:** Fast, easy precision cutting at any point in the material. Narrow waist means outstanding cutting speed and quality.

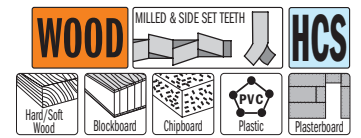

PACK Quantity	W mm	I mm	TS mm	TPI		ORDER NO. Starlock
1 in clamshell	35	50	1,4	18	1	<b>OMF133-X1</b>
5 in clamshell	35	50	1,4	18	1	<b>OMF133-X5</b>
50 in masterpack	35	50	1,4	18	1	<b>OMF133-X50</b>

**OMF126 STARLOCK**



**35mm Precision Cut, Japanese tothing for Wood**

- FEATURES:** HCS with hardened teeth featuring double-row pattern "Japanese tothing".
- MATERIAL:** For all wood products up to 50mm, blockboard, plasterboard and soft plastics.
- APPLICATION:** Excellent cutting quality and speed and outstanding precision.

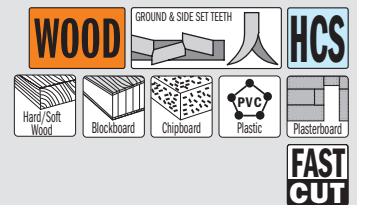

PACK Quantity	W mm	I mm	TS mm	TPI		ORDER NO. Starlock
1 in clamshell	35	50	1,75	14	1	<b>OMF126-X1</b>
5 in clamshell	35	50	1,75	14	1	<b>OMF126-X5</b>
50 in masterpack	35	50	1,75	14	1	<b>OMF126-X50</b>



Japanese Tothing

**OMF233 STARLOCK**



**new**

**45mm Precision Cut, Japanese tothing for Wood**

- FEATURES:** HCS with hardened teeth featuring double-row pattern "Japanese tothing".
- MATERIAL:** For all wood products up to 50mm, blockboard, plasterboard and soft plastics.
- APPLICATION:** Excellent cutting quality and speed, outstanding precision. Medium width waist for a wide range of applications.

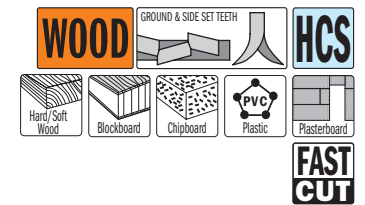

PACK Quantity	W mm	I mm	TS mm	TPI		ORDER NO. Starlock
1 in clamshell	45	50	1,75	14	1	<b>OMF233-X1</b>
5 in clamshell	45	50	1,75	14	1	<b>OMF233-X5</b>
50 in masterpack	45	50	1,75	14	1	<b>OMF233-X50</b>

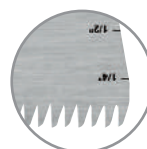

Japanese Tothing

## OMF230 STARLOCK

new



### 35mm Precision Cut, Japanese tothing for Wood

**FEATURES:** HCS with hardened teeth featuring hooked cutting geometry

**MATERIAL:** For all wood products, blockboard, plasterboard and plastics

**APPLICATION:** Wide shape for long, straight, clean cuts and maximum cutting performance with good cutting speed.

**WOOD** GROUND & SIDE SET TEETH **HCS**

Hard/Soft Wood Blockboard Chipboard PVC Plastic Plasterboard

**FAST CUT**

PACK Quantity	W mm	I mm	TS mm	TPI		ORDER NO. Starlock
1 in clamshell	65	50	1,75	14	1	<b>OMF230-X1</b>
5 in clamshell	65	50	1,75	14	1	<b>OMF230-X5</b>
50 in masterpack	65	50	1,75	14	1	<b>OMF230-X50</b>



Japanese Tothing

## OMF205 STARLOCK

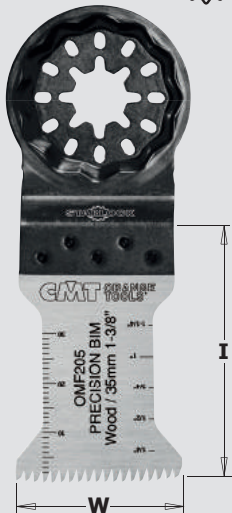

### 35mm Precision Cut, Japanese tothing for Wood. Long Life

**FEATURES:** Reinforced teeth with Bi-metal 8% Cobalt featuring double-row "Japanese tothing" for guaranteed long life.

**MATERIAL:** For all wood materials up to 50mm, blockboard, plasterboard and soft plastics.

**APPLICATION:** Accelerated work performance with optimal precision and speed. Plunge easily at any point in the material. Outstanding cutting quality.

**WOOD** GROUND & SIDE SET TEETH **BIM 8% Co**

Hard/Soft Wood Blockboard Chipboard PVC Plastic Plasterboard

**LONG LIFE FAST CUT**

PACK Quantity	W mm	I mm	TS mm	TPI		ORDER NO. Starlock
1 in clamshell	35	50	1,75	14	1	<b>OMF205-X1</b>
5 in clamshell	35	50	1,75	14	1	<b>OMF205-X5</b>
50 in masterpack	35	50	1,75	14	1	<b>OMF205-X50</b>

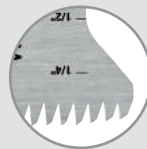

Japanese Tothing

With reduced teeth height for longer lifetime

## OMF232 STARLOCK

new



### 45mm Precision Cut, Japanese tothing for Wood. Long Life

**FEATURES:** Reinforced teeth with Bi-metal 8% Cobalt featuring double-row "Japanese tothing" for guaranteed long life.

**MATERIAL:** For all wood products up to 50mm, blockboard, plasterboard and soft plastics

**APPLICATION:** Medium width waist for outstanding cutting speed and maximum precision. Plunge easily at any point in the material. Exceptional cutting quality and a wide range of applications.

**WOOD** GROUND & SIDE SET TEETH **BIM 8% Co**

Hard/Soft Wood Blockboard Chipboard PVC Plastic Plasterboard

**LONG LIFE FAST CUT**

PACK Quantity	W mm	I mm	TS mm	TPI		ORDER NO. Starlock
1 in clamshell	45	50	1,75	14	1	<b>OMF232-X1</b>
5 in clamshell	45	50	1,75	14	1	<b>OMF232-X5</b>
50 in masterpack	45	50	1,75	14	1	<b>OMF232-X50</b>

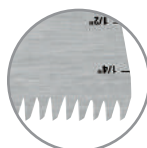

Japanese Tothing

With reduced teeth height for longer lifetime

## OMF229 STARLOCK



65mm Precision Cut, Japanese tothing for Wood. Long Life

**FEATURES:** Reinforced teeth with Bi-metal 8% Cobalt featuring double-row "Japanese tothing" for guaranteed long life.

**MATERIAL:** For all wood products, blockboard, plasterboard and soft plastics.

**APPLICATION:** Superb long straight cuts, extra wide shape for maximum cutting and fast progression. Extremely durable and sturdy.

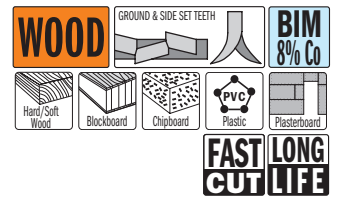

PACK Quantity	W mm	I mm	TS mm	TPI		ORDER NO. Starlock
1 in clamshell	65	50	1,75	14	1	<b>OMF229-X1</b>
5 in clamshell	65	50	1,75	14	1	<b>OMF229-X5</b>
50 in masterpack	65	50	1,75	14	1	<b>OMF229-X50</b>



**Japanese Tothing**  
Reduced tooth height to maximize lifetime

## OMF184 STARLOCK



10mm Plunge and Flush-Cut for Wood & Nails. Long Life

**FEATURES:** Reinforced teeth with Bi-metal 8% Cobalt for long life.

**MATERIAL:** For all wood products, blockboard, plasterboard and soft plastics. Cuts through embedded nails in wood up to 5mm in diameter and even masonry, like porous concrete

**APPLICATION:** Long, super-narrow shape perfect for the smallest cut-outs and tightest groove work.

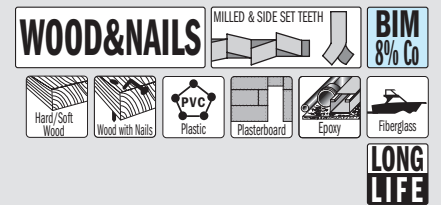

PACK Quantity	W mm	I mm	TS mm	TPI		ORDER NO. Starlock
1 in clamshell	10	30	1,4	18	1	<b>OMF184-X1</b>
5 in clamshell	10	30	1,4	18	1	<b>OMF184-X5</b>
50 in masterpack	10	30	1,4	18	1	<b>OMF184-X50</b>

## OMF183 STARLOCK



20mm Plunge and Flush-Cut for Wood & Nails. Long Life

**FEATURES:** Reinforced teeth with Bi-metal 8% Cobalt for long life.

**MATERIAL:** For all wood products, blockboard, plasterboard and soft plastics. Cuts through embedded nails in wood up to 5mm in diameter and even masonry, like porous concrete.

**APPLICATION:** Short, medium-width shape ideal for groove work and cut-outs. Clean cuts and superb performance for detail oriented jobs. Extreme durability and sturdy.

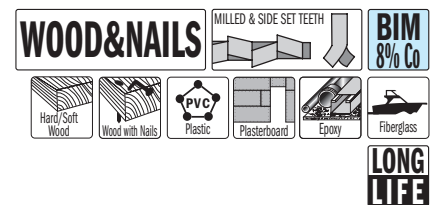

PACK Quantity	W mm	I mm	TS mm	TPI		ORDER NO. Starlock
1 in clamshell	20	34	1,4	18	1	<b>OMF183-X1</b>
5 in clamshell	20	34	1,4	18	1	<b>OMF183-X5</b>
50 in masterpack	20	34	1,4	18	1	<b>OMF183-X50</b>



## OMF160 STARLOCK



**35mm Plunge and Flush-Cut for Wood & Nails. Long Life**

**FEATURES:** Reinforced teeth with Bi-metal 8% Cobalt for long life.

**MATERIAL:** For all wood products, blockboard, plasterboard, fiberglass, epoxy and soft plastics. Cuts through embedded nails in wood up to 5mm in diameter and even masonry, like porous concrete.

**APPLICATION:** Medium width waist ensures superb cutting speed and quality. Plunge easily at any point in the material.

**WOOD&NAILS**

MILLED & SIDE SET TEETH

**BIM**  
8% Co

Hard/Soft Wood

Wood with Nails

PVC

Plasterboard

Epoxy

Fiberglass

**LONG LIFE**

PACK Quantity	W mm	I mm	TS mm	TPI		ORDER NO. Starlock
1 in clamshell	35	50	1,4	18	1	<b>OMF160-X1</b>
5 in clamshell	35	50	1,4	18	1	<b>OMF160-X5</b>
50 in masterpack	35	50	1,4	18	1	<b>OMF160-X50</b>



Join us on our

## OMF221 STARLOCK

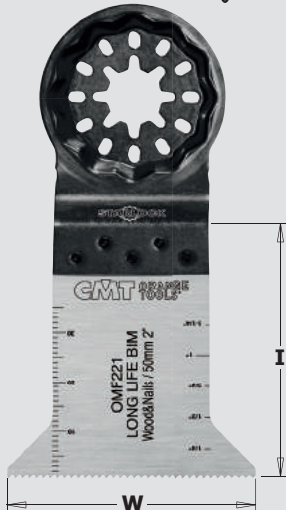

**50mm Plunge and Flush-Cut for Wood & Nails. Long Life**

**FEATURES:** Reinforced teeth with Bi-metal 8% Cobalt for long life.

**MATERIAL:** For all wood products, blockboard, plasterboard, metal, and non-ferrous pipe and profiles such as copper, aluminum and brass as well as soft plastics. Cuts through embedded nails in wood up to 5mm in diameter and even masonry, like porous concrete.

**APPLICATION:** Medium width waist ensures superb cutting speed and quality. Plunge easily at any point in the material.

**WOOD&NAILS**

MILLED & SIDE SET TEETH

**BIM**  
8% Co

Hard/Soft Wood

Wood with Nails

PVC

Plasterboard

Epoxy

Fiberglass

Cu  
Zn  
Non-Ferrous Metals

**LONG LIFE**

PACK Quantity	W mm	I mm	TS mm	TPI		ORDER NO. Starlock
1 in clamshell	50	50	1,4	18	1	<b>OMF221-X1</b>
5 in clamshell	50	50	1,4	18	1	<b>OMF221-X5</b>
50 in masterpack	50	50	1,4	18	1	<b>OMF221-X50</b>

## OMF228 STARLOCK

**new**



**65mm Plunge and Flush-Cut for Wood & Nails. Long Life**

**FEATURES:** Reinforced teeth with Bi-metal 8% Cobalt for long life.

**MATERIAL:** For all wood products, blockboard, plasterboard and soft plastics. Cuts through embedded nails in wood up to 5mm.

**APPLICATION:** Superb long straight, clean cuts: Extra wide shape for maximum cutting performance. Extremely durable and sturdy.

**WOOD&NAILS**

MILLED & SIDE SET TEETH

**BIM**  
8% Co

Hard/Soft Wood

Wood with Nails

PVC

Plasterboard

**LONG LIFE**

PACK Quantity	W mm	I mm	TS mm	TPI		ORDER NO. Starlock
1 in clamshell	65	50	1,4	18	1	<b>OMF228-X1</b>
5 in clamshell	65	50	1,4	18	1	<b>OMF228-X5</b>
50 in masterpack	65	50	1,4	18	1	<b>OMF228-X50</b>

Cutting Tools for Multi-Cutters

**OMF222 STARLOCK**



28mm Plunge and Flush-Cut for Wood & Metal. Long Life

**FEATURES:** Reinforced teeth with Bi-metal 8% Cobalt for long life featuring milled & wavy universal toothing.

**MATERIAL:** For sheet metal up to 2mm, wood products, plasterboard and soft plastics, non-ferrous pipe and profiles such as copper, aluminum and brass.

**APPLICATION:** Fast, easy precision cutting at any point in the material. Narrow waist means outstanding cutting speed and quality. Plunge easily at any point in the material.

**WOOD&METAL** MILLED & WAVY SET TEETH BIM 8% Co

Hard/Soft Wood Wood with Nails PVC Plastic ALU Aluminium Sheet Metal Non-Ferrous Metals

Plasterboard Cu Zn Non-Ferrous Metals 130% LONGER LIFE LONG LIFE

PACK Quantity	W mm	I mm	TS mm	TPI	Box Icon	ORDER NO. Starlock
1 in clamshell	28	55	1,4	18	1	<b>OMF222-X1</b>
5 in clamshell	28	55	1,4	18	1	<b>OMF222-X5</b>
50 in masterpack	28	55	1,4	18	1	<b>OMF222-X50</b>

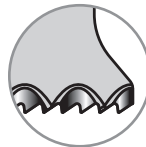

**WAVY UNIVERSAL TOOTHING**

**OMF223 STARLOCK**



44mm Plunge and Flush-Cut for Wood & Metal. Long Life

**FEATURES:** Reinforced teeth with Bi-metal 8% Cobalt for long life featuring milled & wavy universal toothing.

**MATERIAL:** For sheet metal up to 2mm, wood products, plasterboard and soft plastics, non-ferrous pipe and profiles such as copper, aluminum and brass.

**APPLICATION:** Fast, easy precision cutting at any point in the material. Wide waist means outstanding cutting speed and quality. Plunge easily at any point in the material.

**WOOD&METAL** MILLED & WAVY SET TEETH BIM 8% Co

Hard/Soft Wood Wood with Nails PVC Plastic ALU Aluminium Sheet Metal Non-Ferrous Metals

Plasterboard Cu Zn Non-Ferrous Metals 130% LONGER LIFE LONG LIFE

PACK Quantity	W mm	I mm	TS mm	TPI	Box Icon	ORDER NO. Starlock
1 in clamshell	44	55	1,4	18	1	<b>OMF223-X1</b>
5 in clamshell	44	55	1,4	18	1	<b>OMF223-X5</b>
50 in masterpack	44	55	1,4	18	1	<b>OMF223-X50</b>



**WAVY UNIVERSAL TOOTHING**

**OMF157 STARLOCK**



30mm Plunge and Flush-Cut for Metal. Fine Cut

**FEATURES:** Reinforced teeth with Bi-metal 8% Cobalt for long life featuring thin kerf.

**MATERIAL:** For sheet metal up to 2mm, hard plastics, non-ferrous pipe and profiles such as copper, aluminum and brass, and fiberglass (GFRP)

**APPLICATION:** For fine, thin and precise cuts. Easy control. Medium waist for faster cutting and good swarf evacuation.

**METAL** MILLED & WAVY SET TEETH BIM 8% Co

Sheet Metal Aluminium PVC Plastic Pipes, Profiles Epoxy

Fiberglass Cu Zn Non-Ferrous Metals FINE CUT

PACK Quantity	W mm	I mm	TS mm	TPI	Box Icon	ORDER NO. Starlock
1 in clamshell	30	50	1,2	21	1	<b>OMF157-X1</b>
5 in clamshell	30	50	1,2	21	1	<b>OMF157-X5</b>
50 in masterpack	30	50	1,2	21	1	<b>OMF157-X50</b>

## OMF118 STARLOCK

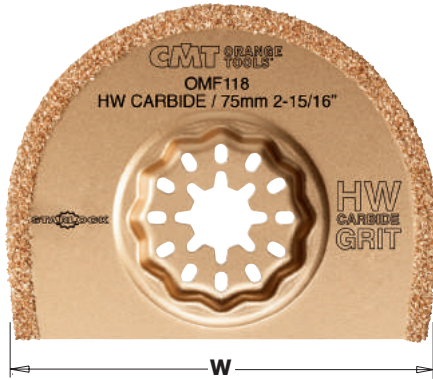

### 75mm Carbide Grit Radial Saw Blade

**FEATURES:** Carbide Grit Radial saw blade, segmented.

**MATERIAL:** For tile joints, plasterboard, porous concrete, construction materials and reworking or cleaning planked deck joints.

**APPLICATION:** An economic option to diamond tools. For milling wall joints or floors, carving grooves on porous concrete, laying concealed cables or pipes. Ideal for working close to corners and edges. Not suitable for joint work on very hard epoxy resin or cement joints.

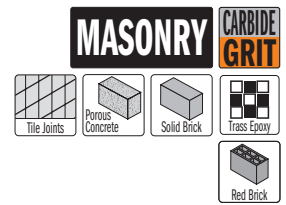

PACK Quantity	W mm	K mm		ORDER NO. Starlock
1 in clamshell	75	2,2	1	<b>OMF118-X1</b>
5 in clamshell	75	2,2	1	<b>OMF118-X5</b>

## OMF125 STARLOCK



### 75mm Carbide Grit Radial Saw Blade

**FEATURES:** Carbide Grit Radial Saw Blade, segmented.

**MATERIAL:** For tile joints, plasterboard, porous concrete, construction materials and reworking or cleaning planked deck joints.

**APPLICATION:** An economic option to diamond tools. For milling wall joints or floors, carving grooves on porous concrete for the purpose of laying concealed cables or pipes. Ideal for working close to corners and edges. Not suitable for joint work on very hard epoxy resin or cement joints.

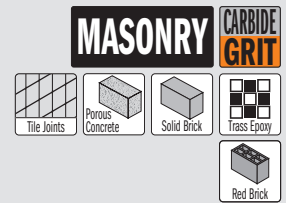

PACK Quantity	W mm	K mm		ORDER NO. Starlock
1 in clamshell	75	1,2	1	<b>OMF125-X1</b>
5 in clamshell	75	1,2	1	<b>OMF125-X5</b>

## OMF114 STARLOCK



### 75mm Diamond Coated Extra-Long Life Radial Saw Blade

**FEATURES:** Diamond coated Radial Saw Blade for extra-long life-time.

**MATERIAL:** For tiles, plasterboard, porous concrete, construction materials and reworking planked deck joints. Suitable for hard epoxy resin and cement joints.

**APPLICATION:** Best for frequent use and challenging jobs. For milling wall joints, carving grooves in porous concrete for the purpose of laying concealed cables and pipes. Ideal for working close to corners and edges. Cutting width approx. 2.2mm.

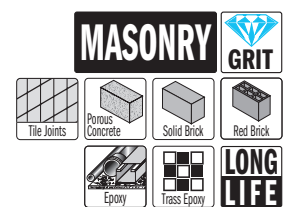

PACK Quantity	W mm	K mm		ORDER NO. Starlock
1 in clamshell	75	2,2	1	<b>OMF114-X1</b>
5 in clamshell	75	2,2	1	<b>OMF114-X5</b>



Cutting & Filing Tools for Multi-Cutters

**OMF002 STARLOCK PLUS**



**45mm Double-Face Carbide Grit Fingertip Rasp**

**FEATURES:** Double-sided Carbide Grit.  
**MATERIAL:** For tiles, plasterboard, porous concrete, stone, construction materials, wood and carpet adhesives.  
**APPLICATION:** Fingertip rasp perfect for coarse grinding in tight corners, grooves, channels, openings, slots, gaps and rabbets. For mold-making in curves, slots and artistic work.



PACK Quantity	W mm	I mm		ORDER NO. StarlockPlus
1 in clamshell	33	45	1	<b>OMF002-X1</b>

**OMF001 STARLOCK**



**80mm Carbide Grit Delta Rasp**

**FEATURES:** Carbide Grit Delta Rasp.  
**MATERIAL:** For tiles and tile adhesives, plasterboard, porous concrete, stone, fiberglass, plastics, construction material, wood and carpet adhesives.  
**APPLICATION:** For tight corners and cramped work areas and for removing mortar and adhesives, removing carpet adhesive residues, rasping wood, rough grinding of filler and tile adhesive.

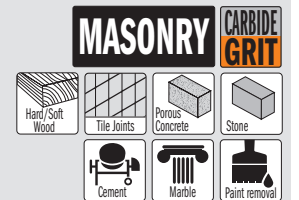

PACK Quantity	W mm		ORDER NO. Starlock
1 in clamshell	80	1	<b>OMF001-X1</b>

**OMF243 STARLOCK MAX**



**60mm Diamond Coated Extra-Long Life Segment Saw Blade**

**FEATURES:** Diamond coated for extra-long life, Segmented Saw Blade.  
**MATERIAL:** For tiles, marble, hard epoxy resins and cement grouts.  
**APPLICATION:** Best for frequent use and challenging jobs in tight corners and edges. Efficient shape allows aggressive grinding without damaging tile. Cuts out marble and trass concrete joints, great for sinking ducts in plaster, pumice, brick and honeycomb stone as well as autoclave aerated concrete. Cutting width approx. 2.2mm

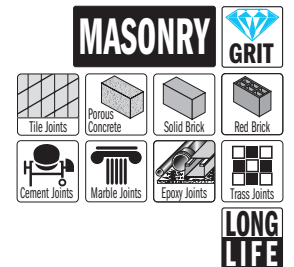

PACK Quantity	W mm	K mm		ORDER NO. StarlockMax
1 in clamshell	60	2,2	1	<b>OMF243-X1</b>

## OMF226 STARLOCK



### 52mm Rigid Scraper Blade for All Materials

**FEATURES:** Rigid Scraper in HL.

**MATERIAL:** Removes tough paint layers and stubborn adhesive residues, scrapes away carpet, tile adhesives and underseal.

**APPLICATION:** For a wide range of applications: Removes mortar or tile adhesives and concrete residues. Scrapes away hard, brittle carpet adhesive residue.

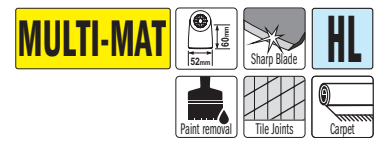

Pack Quantity	W mm	K mm		ORDER NO. Starlock
1 in clamshell	52	0,8	1	<b>OMF226-X1</b>

## OMF165 STARLOCK



### 52mm Flexible Scraper Blade for All Materials

**FEATURES:** Flexible Scraper in HL.

**MATERIAL:** Soft and semi-soft materials like silicone, caulking for plumbing jobs and stickers.

**APPLICATION:** For a wide range of applications: removes soft carpet adhesive residue, paint residues and silicone joints.

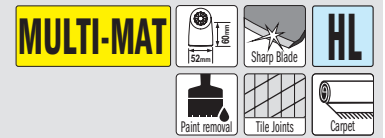

Pack Quantity	W mm	K mm		ORDER NO. Starlock
1 in clamshell	52	0,4	1	<b>OMF165-X1</b>

## OMF245 STARLOCK



### 70mm "Mushroom-Shaped" Cutting Blade for All Materials

**FEATURES:** "Mushroom Shaped" blade in HL.

**MATERIAL:** For cutting silicone, caulking, soft putty as well as glazing compounds.

**APPLICATION:** Blade shape keeps hands safely away from broken glass when repairing window panes and/or separating insulated glass panels.



Pack Quantity	W mm	K mm		ORDER NO. Starlock
5 in clamshell	70	0,4	1	<b>OMF245-X5</b>

**OMF201 STARLOCK PLUS**



new



**4mm Angled Gouging Blade**

**FEATURES:** Angled Gouging blade in HCS.  
**MATERIAL:** For cutting, gouging and digging out soft materials like sealant, caulk and silicone from tight recesses.  
**APPLICATION:** For cleaning out tight notches and narrow recesses or crevices. Specialized blade for boat maintenance such as cabins, rails, gunwales, cleats and curves. Ideal for cutting out sealant on boats with panelled decks.



PACK Quantity	K mm	W mm	I mm		ORDER NO. StarlockPlus
1 in clamshell	4	16	11	1	<b>OMF201-X1</b>

**OMF251 STARLOCK**



new



**41mm Multi-Knife with Three Cutting Surfaces**

**FEATURES:** Multi-Knife, segmented with three cutting surfaces.  
**MATERIAL:** For cutting carpet, soft materials like sealant and foam insulation, leather goods, PVC flooring, cardboard, bitumen shingles and roofing paper.  
**APPLICATION:** Unique shape means that material can be cut simply by pulling, pushing or pressing. Ideal for grout between tiles and removing carpet, PVC floors, cardboard, bitumen shingles and roofing fabric.



PACK Quantity	W mm	I mm		ORDER NO. Starlock
1 in clamshell	41	41	1	<b>OMF251-X1</b>

**OMF-X4 STARLOCK**



new

**4 piece Multipurpose Set for Oscillating Multi-tools**

- 2 blades with Japanese Tothing for all wood products, blockboard, plasterboard and plastics.
- 2 blades in BIM for all wood products, blockboard, plasterboard, fiberglass, epoxy and soft plastics. Cuts through embedded nails in wood up to 5mm in diameter and even masonry, like porous concrete.

**WOOD WOOD&NAILS**



8 Sets in End-cap display (minimum order 8 sets)



PACK Quantity	MATERIAL	W mm	I mm	TS mm	TPI		ORDER NO.
1	HCS	35	50	1,75	14	8	<b>OMF126-X1</b>
1	BIM	35	50	1,4	18	8	<b>OMF160-X1</b>
1	BIM	50	50	1,4	18	8	<b>OMF221-X1</b>
1	HCS	65	50	1,75	14	8	<b>OMF230-X1</b>



**OMF136 STARLOCK**

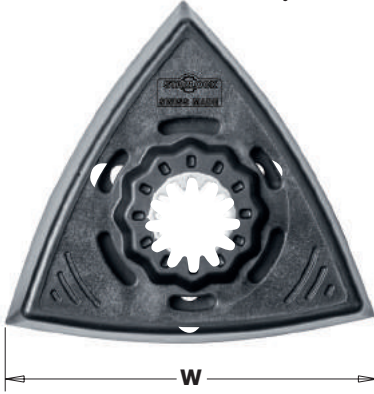

**93mm Delta Sanding Pad, Perforated**

**FEATURES:** perforated Sanding pad with micro Velcro®-type fastening system. Quick, easy sanding sheet changes.

**APPLICATION:** perfectly sands surfaces on any material. Comprehensive range of sanding sheets permits a wide range of sanding applications.



PACK Quantity	W mm		ORDER NO. Starlock
1 in clamshell	93	1	<b>OMF136-X1</b>

**OMA30000**



**93mm Delta Polishing Fleece, Perforated**

**FEATURES:** Delta Polishing Fleece with micro Velcro®-type to be use with our sku # OMM30 and # OMS30 and # OMF136.

**APPLICATION:** wide range of applications: suitable for bringing out grain in wood (rustic look), de-rusting metal, matte sanding varnished surfaces and glass, removing dirt and deposits without altering the workpiece surface.

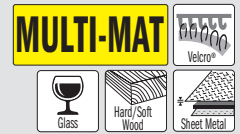

PACK Quantity	W mm		ORDER NO.
4 in clamshell	93	10	<b>OMA30000-X4</b>

**OMA30**



**93mm Aluminium-Oxide Delta Sandpaper for Wood, Perforated**

**FEATURES:** Delta Sandpaper lined with self adhesive micro Velcro® - for use with skus #OMM30 and #OMS30 and #OMF136.

**APPLICATION:** wide range of applications: suitable for sanding all types of wood, chipboard, plywood, construction boards, for pre-sanding of rough, uneven beams and boards. Best results achieved with dust extractor. Aluminium-Oxide abrasive grain and full resin bond guarantee high abrasion performance.



PACK Quantity	W mm	GRIT		ORDER NO.
10 in clamshell	93	40	10	<b>OMA30040-X10</b>
10 in clamshell	93	60	10	<b>OMA30060-X10</b>
10 in clamshell	93	80	10	<b>OMA30080-X10</b>
10 in clamshell	93	100	10	<b>OMA30100-X10</b>
10 in clamshell	93	120	10	<b>OMA30120-X10</b>
10 in clamshell	93	180	10	<b>OMA30180-X10</b>
10 in clamshell	93	240	10	<b>OMA30240-X10</b>

**THE RIGHT BLADE FOR THE BEST RESULTS!**

Quick reference charts and pictograms help you choose the right blade for your application.



**CMT Universal arbor fits directly onto almost all different commercially available multitools**

This tool mount also enables the accessory to be repositioned in 30-degree steps.

**Arbor for Fein® SuperCut and Festool® Vecturo**

This tool mount also enables the accessory to be repositioned in 30-degree steps.

**OMA31**

**Universal Adapters**

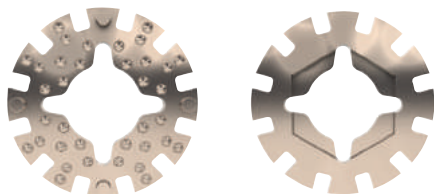

Hardwearing universal adapter allowing your CMT to attach multi-tool blades that do not have matching shanks. Fits snugly and does not slip. Ideal for Bosch, Chicago, Craftsman, Dremel, Fein, Makita, Milwaukee, Mastercraft, Ozito, Aeg, Ridgid, Rockwell, Smart, Wox.

<b>PACK</b> Quantity		<b>ORDER NO.</b>
2 in clamshell	10	<b>OMA31-X2</b>

**OMM01 OMS01**

Universal Arbor

Arbor for Fein® SuperCut Festool® Vecturo



**10mm Plunge and Flush-Cut for Wood**

**FEATURES:** HCS with hardened teeth.  
**MATERIAL:** for wood, blockboard, chipboard, plastic, pipes and profiles.  
**APPLICATION:** wide range of applications: installing a ventilation grille, cutting a recess in furniture elements to enable access to a mains socket, adjustment work in wood like sawing recesses for locks and fitting, window and door hardware.

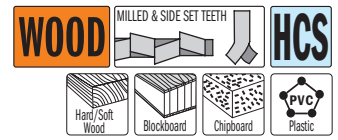

Pack Quantity	W mm	I mm	TPI		ORDER NO. Universal Arbor	ORDER NO. Arbor for Fein® Supercut
1 in clamshell	10	28	18	10	<b>OMM01-X1</b>	<b>OMS01-X1</b>

**OMM02 OMS02**

Universal Arbor

Arbor for Fein® SuperCut Festool® Vecturo



**22mm Plunge and Flush-Cut for Wood**

**FEATURES:** HCS with hardened teeth.  
**MATERIAL:** for wood, blockboard, chipboard, plastic, pipes and profiles.  
**APPLICATION:** wide range of applications: installing a ventilation grille, cutting a recess in furniture elements to enable access to a mains socket, flush-cutting wooden components to length (like dowels and tenons), window and door hardware.

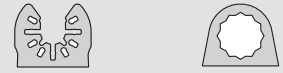
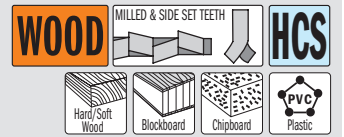

Pack Quantity	W mm	I mm	TPI		ORDER NO. Universal Arbor	ORDER NO. Arbor for Fein® Supercut
1 in clamshell	22	48	18	10	<b>OMM02-X1</b>	<b>OMS02-X1</b>
5 in clamshell	22	48	18	5	<b>OMM02-X5</b>	<b>OMS02-X5</b>

**OMM03 OMS03**

Universal Arbor

Arbor for Fein® SuperCut Festool® Vecturo



**28mm Plunge and Flush-Cut for Wood**

**FEATURES:** HCS with hardened teeth.  
**MATERIAL:** for wood, blockboard, chipboard, plastic, pipes and profiles.  
**APPLICATION:** wide range of applications: installing a ventilation grille, cutting a recess in furniture elements to enable access to a mains socket, flush-cutting wooden components to length (like dowels and tenons), window and door hardware.

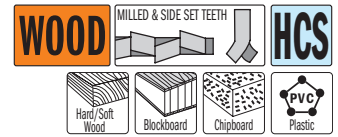

Pack Quantity	W mm	I mm	TPI		ORDER NO. Universal Arbor	ORDER NO. Arbor for Fein® Supercut
1 in clamshell	28	48	18	10	<b>OMM03-X1</b>	<b>OMS03-X1</b>
50 in masterpack	28	48	18	2	<b>OMM03-X50</b>	<b>OMS03-X50</b>

**OMM04 OMS04**

Universal Arbor

Arbor for Fein® SuperCut Festool® Vecturo

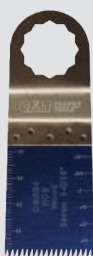
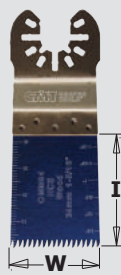

**34mm Precision Cut, Japanese tooting for Wood**

**FEATURES:** HCS with "Japanese" double-row pattern, hardened teeth.  
**MATERIAL:** for wood, timber, blockboard, chipboard.  
**APPLICATION:** ground and side set teeth for precision, clean, quick cutting into soft wood and timber. This tooth pattern with its longer teeth allows you to start cutting from a precise point by standing the blade on its corner and lowering it into the wood.

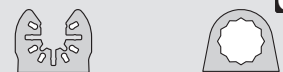
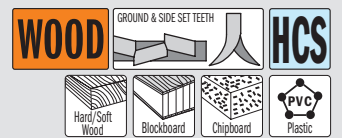

Pack Quantity	W mm	I mm	TPI		ORDER NO. Universal Arbor	ORDER NO. Arbor for Fein® Supercut
1 in clamshell	34	40	14	10	<b>OMM04-X1</b>	<b>OMS04-X1</b>
5 in clamshell	34	40	14	5	<b>OMM04-X5</b>	<b>OMS04-X5</b>
50 in masterpack	34	40	14	2	<b>OMM04-X50</b>	<b>OMS04-X50</b>

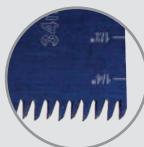

Japanese Tooting



**OMM05**

Universal Arbor

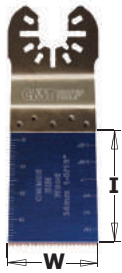

**OMS05**

Arbor for Fein® SuperCut Festool® Vecturo



**34mm Extra-Long Life Plunge and Flush-Cut for Wood**

**FEATURES:** Bi-metal with 8% Cobalt teeth guarantee extra-long life.  
**MATERIAL:** for wood, blockboard, chipboard, plastic, pipes and profiles.  
**APPLICATION:** wide range of applications: installing a ventilation grille, cutting a recess in furniture elements to enable access to a mains socket, flush-cutting wooden components to length (like dowels and tenons), window and door hardware.

**WOOD** MILLED & SIDE SET TEETH

Hard/Soft Wood, Blockboard, Chipboard

**BIM 8% Co**

PVC Plastic

**LONG LIFE**

Pack Quantity	W mm	I mm	TPI		ORDER NO. Universal Arbor	ORDER NO. Arbor for Fein® Supercut
1 in clamshell	34	40	18	10	<b>OMM05-X1</b>	<b>OMS05-X1</b>
5 in clamshell	34	40	18	5	<b>OMM05-X5</b>	<b>OMS05-X5</b>
50 in masterpack	34	40	18	2	<b>OMM05-X50</b>	<b>OMS05-X50</b>

**OMM36**

Universal Arbor



**OMS36**

Arbor for Fein® SuperCut Festool® Vecturo



**45mm Precision Cut, Japanese tothing for Wood**

**FEATURES:** HCS with "Japanese" double-row pattern, hardened teeth.  
**MATERIAL:** for wood, timber, blockboard, chipboard.  
**APPLICATION:** ground and side-set teeth for precision, clean, quick cutting into soft wood and timber. This tooth pattern with its longer teeth allows you to start cutting from a precise point by standing the blade on its corner and lowering it into the wood. Ideal width for creating long flat horizontal cuts like: door jambs and skirting board.

**WOOD** GROUND & SIDE SET TEETH

Hard/Soft Wood, Blockboard, Chipboard

**HCS**

PVC Plastic

**FAST CUT**

Pack Quantity	W mm	I mm	TPI		ORDER NO. Universal Arbor	ORDER NO. Arbor for Fein® Supercut
5 in clamshell	45	50	14	5	<b>OMM36-X5</b>	<b>OMS36-X5</b>
50 in masterpack	45	50	14	2	<b>OMM36-X50</b>	<b>OMS36-X50</b>

Japanese Tothing

**OMM06**

Universal Arbor

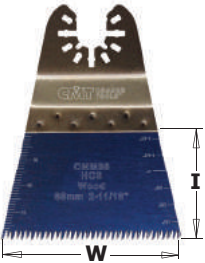

**OMS06**

Arbor for Fein® SuperCut Festool® Vecturo

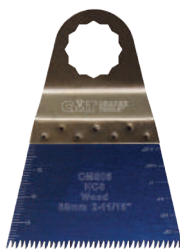

**68mm Precision Cut, Japanese tothing for Wood**

**FEATURES:** HCS with "Japanese" double-row pattern, hardened teeth.  
**MATERIAL:** for wood, timber, blockboard, chipboard.  
**APPLICATION:** ground and side-set teeth for precision, clean, quick cutting into soft wood and timber. This tooth pattern with its longer teeth allows you to start cutting from a precise point by standing the blade on its corner and lowering it into the wood. Ideal width for creating long flat horizontal cuts like: door jambs and skirting board.

**WOOD** GROUND & SIDE SET TEETH

Hard/Soft Wood, Blockboard, Chipboard

**HCS**

PVC Plastic

**FAST CUT**

Pack Quantity	W mm	I mm	TPI		ORDER NO. Universal Arbor	ORDER NO. Arbor for Fein® Supercut
1 in clamshell	68	40	14	10	<b>OMM06-X1</b>	<b>OMS06-X1</b>
5 in clamshell	68	40	14	5	<b>OMM06-X5</b>	<b>OMS06-X5</b>
50 in masterpack	68	40	14	2	<b>OMM06-X50</b>	<b>OMS06-X50</b>

Japanese Tothing

**OMM07**

Universal Arbor

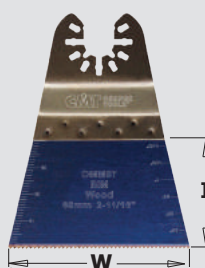

**OMS07**

Arbor for Fein® SuperCut Festool® Vecturo

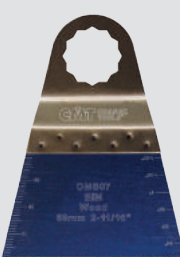

**68mm Extra-Long Life Plunge and Flush-Cut for Wood**

**FEATURES:** Bi-metal with 8% Cobalt teeth guarantee extra-long life.  
**MATERIAL:** for wood, blockboard, chipboard, plastic, pipes and profiles.  
**APPLICATION:** wide range of applications: installing a ventilation grille, cutting a recess in furniture elements to enable access to a mains socket, flush-cutting wooden components to length (like dowels and tenons), window and door hardware.

**WOOD** MILLED & SIDE SET TEETH

Hard/Soft Wood, Blockboard, Chipboard

**BIM 8% Co**

PVC Plastic

**LONG LIFE**

Pack Quantity	W mm	I mm	TPI		ORDER NO. Universal Arbor	ORDER NO. Arbor for Fein® Supercut
1 in clamshell	68	40	18	10	<b>OMM07-X1</b>	<b>OMS07-X1</b>
5 in clamshell	68	40	18	5	<b>OMM07-X5</b>	<b>OMS07-X5</b>
50 in masterpack	68	40	18	2	<b>OMM07-X50</b>	<b>OMS07-X50</b>

**OMM08**

Universal Arbor

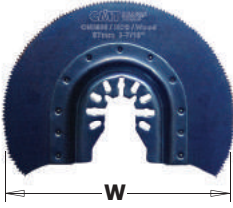

**OMS08**

Arbor for Fein® SuperCut Festool® Vecturo



**87mm Radial Saw Blade for Wood**

**FEATURES:** HCS with hardened teeth.  
**MATERIAL:** for wood, blockboard, chipboard, plastic, pipes and profiles.  
**APPLICATION:** wide range of applications: installing a ventilation grille, cutting a recess in furniture elements to enable access to a mains socket, flush-cutting wooden components to length (like dowels and tenons).  
 Cutting a plastic pipe (PVC) to length.

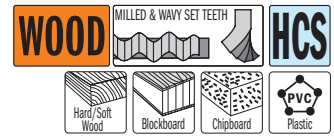

Pack Quantity	W mm	TPI		ORDER NO. Universal Arbor	ORDER NO. Arbor for Fein® SuperCut
1 in clamshell	87	18	10	<b>OMM08-X1</b>	<b>OMS08-X1</b>

**OMM09**

Universal Arbor



**OMS09**

Arbor for Fein® SuperCut Festool® Vecturo



**10mm Plunge and Flush-Cut for Wood & Metal**

**FEATURES:** Bi-metal with 8% Cobalt teeth.  
**MATERIAL:** for wood, chipboard, plastic, sheet metal, copper and aluminium pipes and profiles.  
**APPLICATION:** wide range of applications: flush-cutting a nail in wood, adjustment work on non-ferrous profiles, plunge-cutting in plasterboard.

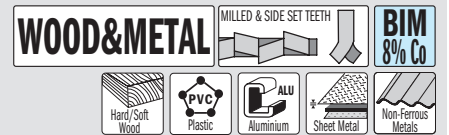

Pack Quantity	W mm	I mm	TPI		ORDER NO. Universal Arbor	ORDER NO. Arbor for Fein® SuperCut
1 in clamshell	10	28	18	10	<b>OMM09-X1</b>	<b>OMS09-X1</b>
5 in clamshell	10	28	18	5	<b>OMM09-X5</b>	<b>OMS09-X5</b>
50 in masterpack	10	28	18	2	<b>OMM09-X50</b>	<b>OMS09-X50</b>

**OMM10**

Universal Arbor

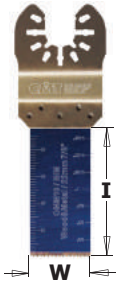

**OMS10**

Arbor for Fein® SuperCut Festool® Vecturo



**22mm Plunge and Flush-Cut for Wood & Metal**

**FEATURES:** Bi-metal with 8% Cobalt teeth.  
**MATERIAL:** for wood, plasterboard, plastic, sheet metal, copper and aluminium pipes and profiles.  
**APPLICATION:** wide range of applications: flush-cutting a nail in wood, cutting copper pipes, plunge-cutting in plasterboard.

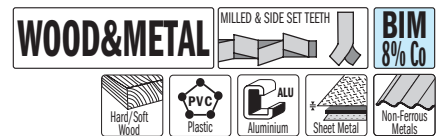

Pack Quantity	W mm	I mm	TPI		ORDER NO. Universal Arbor	ORDER NO. Arbor for Fein® SuperCut
1 in clamshell	22	48	18	10	<b>OMM10-X1</b>	<b>OMS10-X1</b>
5 in clamshell	22	48	18	5	<b>OMM10-X5</b>	<b>OMS10-X5</b>
50 in masterpack	22	48	18	2	<b>OMM10-X50</b>	<b>OMS10-X50</b>

**OMM11**

Universal Arbor



**OMS11**

Arbor for Fein® SuperCut Festool® Vecturo



**28mm Plunge and Flush-Cut for Wood & Metal**

**FEATURES:** Bi-metal with 8% Cobalt teeth.  
**MATERIAL:** for wood, plasterboard, plastic, sheet metal, copper and aluminium pipes and profiles.  
**APPLICATION:** wide range of applications: flush-cutting a nail in wood, cutting copper pipes and aluminium profiles, plunge-cutting in plasterboard.



Pack Quantity	W mm	I mm	TPI		ORDER NO. Universal Arbor	ORDER NO. Arbor for Fein® SuperCut
1 in clamshell	28	48	18	10	<b>OMM11-X1</b>	<b>OMS11-X1</b>
5 in clamshell	28	48	18	5	<b>OMM11-X5</b>	<b>OMS11-X5</b>
50 in masterpack	28	48	18	2	<b>OMM11-X50</b>	<b>OMS11-X50</b>

## OMM12

Universal Arbor

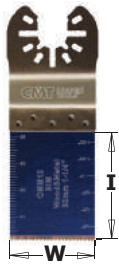

## OMS12

Arbor for Fein® SuperCut Festool® Vecturo



### 32mm Plunge and Flush-Cut for Wood & Metal

**FEATURES:** Bi-metal with 8% Cobalt teeth.  
**MATERIAL:** for wood, plasterboard, plastic, sheet metal, copper and aluminium pipes and profiles.  
**APPLICATION:** wide range of applications: flush-cutting a nail in wood, cutting copper pipes and aluminium profiles, plunge-cutting in plasterboard.

**WOOD&METAL** MILLED & SIDE SET TEETH **BIM 8% Co**

Hard/Soft Wood PVC Plastic ALU Aluminium Sheet Metal Non-Ferrous Metals

PACK Quantity	W mm	I mm	TPI		ORDER NO. Universal Arbor	ORDER NO. Arbor for Fein® Supercut
1 in clamshell	32	40	18	10	<b>OMM12-X1</b>	<b>OMS12-X1</b>
5 in clamshell	32	40	18	5	<b>OMM12-X5</b>	<b>OMS12-X5</b>
50 in masterpack	32	40	18	2	<b>OMM12-X50</b>	<b>OMS12-X50</b>

## OMM13

Universal Arbor

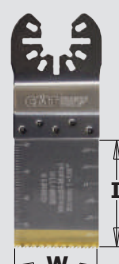

## OMS13

Arbor for Fein® SuperCut Festool® Vecturo



### 32mm Extra-Long Life Plunge & Flush-Cut for Wood & Metal

**FEATURES:** TiN Coated Bi-metal with 8% Cobalt teeth.  
**MATERIAL:** for wood and nails, plasterboard, plastic, sheet metal, copper and aluminium pipes and profiles.  
**APPLICATION:** wide range of applications: flush-cutting a nail in wood, cutting copper pipes and aluminium profiles, plunge-cutting in plasterboard. Tooth strip coated with titanium nitride for 30% longer life.

**WOOD&METAL** MILLED & SIDE SET TEETH **BIM TiN**

Hard/Soft Wood PVC Plastic ALU Aluminium Sheet Metal Non-Ferrous Metals

**130% LONGER LIFE** **LONG LIFE**

PACK Quantity	W mm	I mm	TPI		ORDER NO. Universal Arbor	ORDER NO. Arbor for Fein® Supercut
1 in clamshell	32	40	18	10	<b>OMM13-X1</b>	<b>OMS13-X1</b>
5 in clamshell	32	40	18	5	<b>OMM13-X5</b>	<b>OMS13-X5</b>
50 in masterpack	32	40	18	2	<b>OMM13-X50</b>	<b>OMS13-X50</b>

## OMM14

Universal Arbor

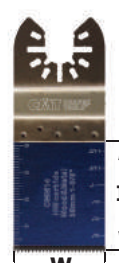

## OMS14

Arbor for Fein® SuperCut Festool® Vecturo



### 35mm Extra-Long Life Plunge & Flush-Cut for Wood & Metal

**FEATURES:** High Quality carbide teeth.  
**MATERIAL:** for wood, hardened screws and nails, plasterboard, plastic, sheet metal, copper, aluminium and stainless steel.  
**APPLICATION:** wide range of applications: cutting hardened screws/nails, Cutting stainless steel like kitchen front covers, plunge cuts in severely abrasive materials like fiberglass.

**WOOD&METAL** **HW**

Hard/Soft Wood PVC Plastic ALU Aluminium Sheet Metal Non-Ferrous Metals

**2X LONGER LIFE** **LONG LIFE**

PACK Quantity	W mm	I mm	TPI		ORDER NO. Universal Arbor	ORDER NO. Arbor for Fein® Supercut
1 in clamshell	35	40	20	10	<b>OMM14-X1</b>	<b>OMS14-X1</b>

## OMM35

Universal Arbor



**EXTRA LONG**

## OMS35

Arbor for Fein® SuperCut Festool® Vecturo



**new**

### 42mm Plunge and Flush-Cut for Wood & Metal

**FEATURES:** Bi-metal with 8% Cobalt teeth.  
**MATERIAL:** for wood, plasterboard, plastic, sheet metal, copper and aluminium pipes and profiles.  
**APPLICATION:** wide range of applications: flush-cutting a nail, cutting copper pipes and aluminium profiles, plunge-cutting in plasterboard.

**WOOD&METAL** MILLED & SIDE SET TEETH **BIM 8% Co**

Hard/Soft Wood PVC Plastic ALU Aluminium Sheet Metal Non-Ferrous Metals

PACK Quantity	W mm	I mm	TPI		ORDER NO. Universal Arbor	ORDER NO. Arbor for Fein® Supercut
5 in clamshell	42	68	18	5	<b>OMM35-X5</b>	<b>OMS35-X5</b>
50 in masterpack	42	68	18	2	<b>OMM35-X50</b>	<b>OMS35-X50</b>



**OMM15**

Universal Arbor

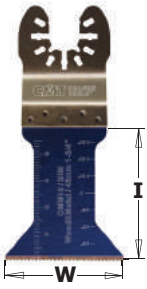

**OMS15**

Arbor for Fein® SuperCut Festool® Vecturo



**45mm Plunge and Flush-Cut for Wood & Metal**

**FEATURES:** Bi-metal with 8% Cobalt teeth.  
**MATERIAL:** for wood, plasterboard, plastic, sheet metal, copper and aluminium pipes and profiles.  
**APPLICATION:** wide range of applications: flush-cutting a nail, cutting copper pipes and aluminium profiles, plunge-cutting in plasterboard.

**WOOD&METAL** MILLED & SIDE SET TEETH **BIM 8% Co**

Hard/Soft Wood PVC Plastic ALU Aluminium Sheet Metal Non-Ferrous Metals

PACK Quantity	W mm	I mm	TPI		ORDER NO. Universal Arbor	ORDER NO. Arbor for Fein® Supercut
1 in clamshell	45	48	18	10	<b>OMM15-X1</b>	<b>OMS15-X1</b>
5 in clamshell	45	48	18	5	<b>OMM15-X5</b>	<b>OMS15-X5</b>
50 in masterpack	45	48	18	2	<b>OMM15-X50</b>	<b>OMS15-X50</b>

**OMM16**

Universal Arbor

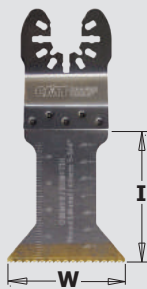

**OMS16**

Arbor for Fein® SuperCut Festool® Vecturo



**45mm Extra-Long Life Plunge & Flush-Cut for Wood & Metal**

**FEATURES:** TiN Coated Bi-metal with 8% Cobalt teeth.  
**MATERIAL:** for wood and nails, plasterboard, plastic, sheet metal, copper and aluminium pipes and profiles.  
**APPLICATION:** wide range of applications: flush-cutting a nail, cutting copper pipes and aluminium profiles, plunge-cutting in plasterboard. Tooth strip coated with titanium nitride for 30% longer life.

**WOOD&METAL** MILLED & SIDE SET TEETH **BIM 8% Co**

Hard/Soft Wood PVC Plastic ALU Aluminium Sheet Metal Non-Ferrous Metals

**130% LONGER LIFE** **LONG LIFE**

PACK Quantity	W mm	I mm	TPI		ORDER NO. Universal Arbor	ORDER NO. Arbor for Fein® Supercut
1 in clamshell	45	48	18	10	<b>OMM16-X1</b>	<b>OMS16-X1</b>
5 in clamshell	45	48	18	5	<b>OMM16-X5</b>	<b>OMS16-X5</b>
50 in masterpack	45	48	18	2	<b>OMM16-X50</b>	<b>OMS16-X50</b>

**OMM17**

Universal Arbor

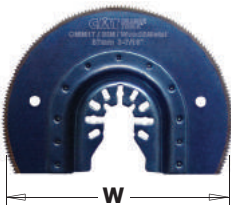

**OMS17**

Arbor for Fein® SuperCut Festool® Vecturo



**87mm Radial Saw Blade for Wood & Metal**

**FEATURES:** Bi-metal with 8% Cobalt teeth.  
**MATERIAL:** for wood, veneered panels, plastic and laminated panels, sheet metal, copper and aluminium pipes and profiles.  
**APPLICATION:** wide range of applications: flush-cutting a nail, cutting a door frame, laminate/parquet, cutting aluminium profiles, plunge-cutting.

**WOOD&METAL** **BIM 8% Co**

Hard/Soft Wood PVC Plastic ALU Aluminium Sheet Metal Non-Ferrous Metals

**LONG LIFE**

PACK Quantity	W mm	TPI		ORDER NO. Universal Arbor	ORDER NO. Arbor for Fein® Supercut
1 in clamshell	87	20	10	<b>OMM17-X1</b>	<b>OMS17-X1</b>

**OMM18**

Universal Arbor

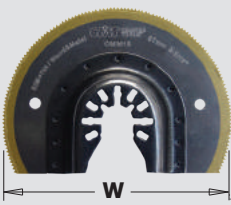

**OMS18**

Arbor for Fein® SuperCut Festool® Vecturo



**87mm Extra-Long Life Radial Saw Blade for Wood & Metal**

**FEATURES:** TiN Coated Bi-metal with 8% Cobalt teeth.  
**MATERIAL:** for wood, plasterboard and fibercement boards, sheet metal, copper and aluminium pipes and profiles.  
**APPLICATION:** wide range of applications: plunge-cutting in plasterboard, cutting smaller aluminium mouldings to length, cutting recesses in epoxy/glass fibre like dashboard in a boat.

**WOOD&METAL** **BIM TiN**

Hard/Soft Wood PVC Plastic ALU Aluminium Sheet Metal Co Zn Non-Ferrous Metals

**130% LONGER LIFE** **LONG LIFE**

PACK Quantity	W mm	TPI		ORDER NO. Universal Arbor	ORDER NO. Arbor for Fein® Supercut
1 in clamshell	87	20	10	<b>OMM18-X1</b>	<b>OMS18-X1</b>

**OMM19**

Universal Arbor

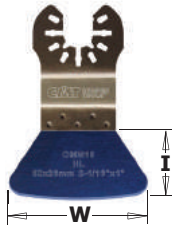

**OMS19**

Arbor for  
Fein® SuperCut  
Festool® Vecturo



**52mm Rigid Scraper for all Materials**

**FEATURES:** HL rigid scraper.

**APPLICATION:** wide range of applications: removing mortar or tile adhesive, removing mortar and concrete residues, removing hard, brittle carpet adhesive residues.



PACK Quantity	W mm	I mm		ORDER NO. Universal Arbor	ORDER NO. Arbor for Fein® Supercut
1 in clamshell	52	26	10	<b>OMM19-X1</b>	<b>OMS19-X1</b>
5 in clamshell	52	26	5	<b>OMM19-X5</b>	<b>OMS19-X5</b>

**OMM20**

Universal Arbor

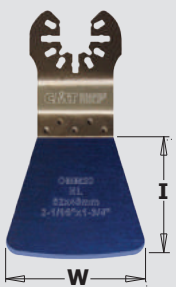

**OMS20**

Arbor for  
Fein® SuperCut  
Festool® Vecturo



**52mm Flexible Scraper for all Materials**

**FEATURES:** HL flexible scraper.

**APPLICATION:** wide range of applications: removing soft carpet adhesive residues, removing paint residues, removing silicone joints.



PACK Quantity	W mm	I mm		ORDER NO. Universal Arbor	ORDER NO. Arbor for Fein® Supercut
1 in clamshell	52	45	10	<b>OMM20-X1</b>	<b>OMS20-X1</b>
5 in clamshell	52	45	5	<b>OMM20-X5</b>	<b>OMS20-X5</b>

**OMM21**

Universal Arbor



**OMS21**

Arbor for  
Fein® SuperCut  
Festool® Vecturo



**28mm Sharp Corner Scraper for all Materials**

**FEATURES:** HL sharp corner scraper.

**APPLICATION:** wide range of applications: cutting soft expansion joints, cutting window putty like sealing compound, cutting insulation materials.



PACK Quantity	W mm	I mm		ORDER NO. Universal Arbor	ORDER NO. Arbor for Fein® Supercut
1 in clamshell	28	50	10	<b>OMM21-X1</b>	<b>OMS21-X1</b>
5 in clamshell	28	50	5	<b>OMM21-X5</b>	<b>OMS21-X5</b>
50 in masterpack	28	50	2	<b>OMM21-X50</b>	<b>OMS21-X50</b>

**OMM22**

Universal Arbor

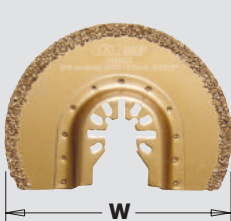

**OMS22**

Arbor for  
Fein® SuperCut  
Festool® Vecturo



**87mm Carbide Grit Radial Saw Blade**

**FEATURES:** Carbide Grit.

**MATERIAL:** radial saw blade for tiles joints, plasterboard, porous concretes and similar construction materials.

**APPLICATION:** wide range of applications: routing joints on wall and floor tiles, smaller cutouts in soft wall tiles, routing grooves in porous concrete, for laying concealed cables and pipes.



PACK Quantity	W mm	K mm		ORDER NO. Universal Arbor	ORDER NO. Arbor for Fein® Supercut
1 in clamshell	87	2,2	10	<b>OMM22-X1</b>	<b>OMS22-X1</b>

**OMM23**

Universal Arbor



**OMS23**

Arbor for  
Fein® SuperCut  
Festool® Vecturo



**87mm Diamond Coated Extra-Long Life Radial Saw Blade**

**FEATURES:** Diamond coated for extended lifetime.  
**MATERIAL:** radial saw blade for tiles joints, plasterboard, porous concretes, construction materials, epoxy and glass fibre.  
**APPLICATION:** wide range of applications: routing joints on wall and floor tiles, smaller cutouts in soft wall tiles, routing recesses in epoxy/glass fibre reinforced plastic like in a boat's hull, routing joints on wall tiles.

**MASONRY GRIT**

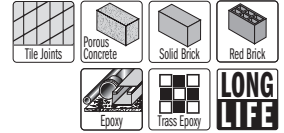

**LONG LIFE**



Pack Quantity	W mm	K mm		ORDER NO. Universal Arbor	ORDER NO. Arbor for Fein® SuperCut
1 in clamshell	87	1,6	10	<b>OMM23-X1</b>	<b>OMS23-X1</b>
25 in masterpack	87	1,6	2	<b>OMM23-X25</b>	<b>OMS23-X25</b>

**OMM24**

Universal Arbor



**OMS24**

Arbor for  
Fein® SuperCut  
Festool® Vecturo



**65mm Carbide Grit Radial Saw Blade**

**FEATURES:** Carbide Grit.  
**MATERIAL:** radial saw blade for tiles joints, plasterboard, porous concretes and similar construction materials.  
**APPLICATION:** wide range of applications: routing joints on wall and floor tiles, smaller cutouts in soft wall tiles, routing grooves in porous concrete, for laying concealed cables and pipes.

**MASONRY CARBIDE GRIT**

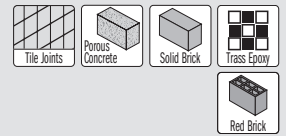

Pack Quantity	W mm	K mm		ORDER NO. Universal Arbor	ORDER NO. Arbor for Fein® SuperCut
1 in clamshell	65	1,6	10	<b>OMM24-X1</b>	<b>OMS24-X1</b>

**OMM27**

Universal Arbor

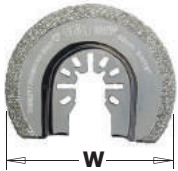

**OMS27**

Arbor for  
Fein® SuperCut  
Festool® Vecturo



**65mm Diamond Coated Extra-Long Life Radial Saw Blade**

**FEATURES:** Diamond coated for extended lifetime.  
**MATERIAL:** radial saw blade for tiles joints, plasterboard, porous concretes, construction materials, epoxy and glass fibre.  
**APPLICATION:** wide range of applications: routing joints on wall and floor tiles, smaller cutouts in soft wall tiles, routing recesses in epoxy/glass fibre reinforced plastic like in a boat's hull, routing joints on wall tiles.

**MASONRY GRIT**

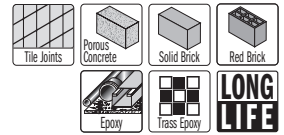

**LONG LIFE**



Pack Quantity	W mm	K mm		ORDER NO. Universal Arbor	ORDER NO. Arbor for Fein® SuperCut
1 in clamshell	65	2	10	<b>OMM27-X1</b>	<b>OMS27-X1</b>

**OMM26**

Universal Arbor



**33mm Double-Face Carbide Grit Fingertip Rasp**

**FEATURES:** Carbide Grit coated on both sides.  
**MATERIAL:** Fingertip Rasp for tiles, plasterboard, porous concretes, construction materials, wood, carpets.  
**APPLICATION:** wide range of applications: removing mortar or tile adhesive, removing carpet adhesive residues, rasping wood for rough adjustment, rough grinding of filler, tile adhesives, concrete, stone and wood.

**MASONRY CARBIDE GRIT**

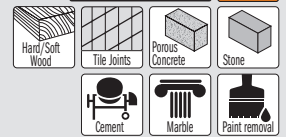

Pack Quantity	W mm	I mm		ORDER NO. Universal Arbor
1 in clamshell	33	35	10	<b>OMM26-X1</b>



**OMM25**

Universal Arbor



**80mm Carbide Grit Delta Rasp**

**FEATURES:** Carbide Grit.

**MATERIAL:** Delta Rasp for tiles, plasterboard, porous concretes, construction materials, wood, carpets.

**APPLICATION:** wide range of applications: removing mortar or tile adhesive, removing carpet adhesive residues, rasping wood for rough adjustment, rough grinding of filler, tile adhesives, concrete, stone and wood.

**MASONRY CARBIDE GRIT**

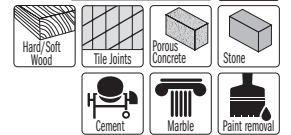

PACK Quantity	W mm		ORDER NO. Universal Arbor
1 in clamshell	80	10	<b>OMM25-X1</b>

**OMM28**

Universal Arbor



**57mm Diamond Coated Extra-Long Life Segment Saw Blade**

**FEATURES:** Diamond coated for extended lifetime.

**MATERIAL:** for tiles, marble, epoxy resins.

**APPLICATION:** wide range of applications: remove tough grout from between tiled surfaces. Efficient shape allows aggressive grinding without damaging the tile. Cutting out marble and trass concrete joints. Also for sinking ducts in plaster, brick, pumice and honeycomb stone as well as autoclave aerated concrete. Long-lasting blades are designed specifically for harder grouts.

**MASONRY GRIT**

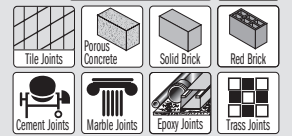

**LONG LIFE**



PACK Quantity	W mm	K mm		ORDER NO. Universal Arbor
1 in clamshell	57	2	10	<b>OMM28-X1</b>
25 in masterpack	57	2	4	<b>OMM28-X25</b>

**OMM29**

Universal Arbor



**OMS29**

Arbor for Fein® SuperCut Festool® Vecturo



**65mm Carbide Grit Grout and Mortar Remover**

**FEATURES:** Carbide Grit.

**MATERIAL:** Grout and Mortar remover for tiles, concrete, stone.

**APPLICATION:** wide range of applications: routing grout, rasping away mortar or tile adhesive, remove joints, tiles, all with one extra long life tool. Suitable for removing carpet residues from a mineral surface. The special design allows access into 90° corners.

**MASONRY CARBIDE GRIT**

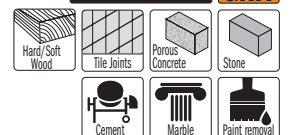

PACK Quantity	W mm		ORDER NO. Universal Arbor	ORDER NO. Arbor for Fein® SuperCut
1 in clamshell	65	10	<b>OMM29-X1</b>	<b>OMS29-X1</b>

**OMM30**

Universal Arbor



**OMS30**

Arbor for Fein® SuperCut Festool® Vecturo



**93mm Delta Sanding Pad, Perforated**

**FEATURES:** perforated sanding pad with self adhesive micro Velcro® makes for quick and easy sanding sheet changes.

**APPLICATION:** the comprehensive range of sanding sheets allows for perfect sanding of any material or any application.

**MULTI-MAT Velcro®**



PACK Quantity	W mm		ORDER NO. Universal Arbor	ORDER NO. Arbor for Fein® SuperCut
1 in clamshell	93	10	<b>OMM30-X1</b>	<b>OMS30-X1</b>

**OMA30000**



**93mm Delta Polishing Fleece, Perforated**

**FEATURES:** Delta Polishing Fleece with self adhesive micro Velcro® for use with skus #OMM30 and #OMS30.

**APPLICATION:** wide range of applications: suitable for bringing out grain in wood (rustic look), de-rusting metal, matte sanding varnished surfaces and glass, removing dirt and deposits without altering the workpiece surface.



PACK Quantity	W mm		ORDER NO.
4 in clamshell	93	10	<b>OMA30000-X4</b>

**OMA30**



**93mm Aluminium-Oxide Delta Sandpaper for Wood, Perforated**

**FEATURES:** Delta Sandpaper with self adhesive micro Velcro® for use with skus #OMM30 and #OMS30.

**APPLICATION:** wide range of applications: suitable for sanding all types of wood, chipboard, plywood, construction boards, for pre-sanding of rough, uneven beams and boards. Best results achieved with dust extractor. Aluminium-Oxide abrasive grain and full resin bond guarantee high abrasion performance.



PACK Quantity	W mm	GRIT		ORDER NO.
10 in clamshell	93	40	10	<b>OMA30040-X10</b>
10 in clamshell	93	60	10	<b>OMA30060-X10</b>
10 in clamshell	93	80	10	<b>OMA30080-X10</b>
10 in clamshell	93	100	10	<b>OMA30100-X10</b>
10 in clamshell	93	120	10	<b>OMA30120-X10</b>
10 in clamshell	93	180	10	<b>OMA30180-X10</b>
10 in clamshell	93	240	10	<b>OMA30240-X10</b>

**OMM-X4**



**4 piece Multipurpose Set for Oscillating Multi-tools**

- 2 blades with Japanese Tothing for all wood products, blockboard, plasterboard and plastics.
- 2 blades in BIM for all wood products, blockboard, plasterboard, fiberglass, epoxy, soft plastics, sheet metal, copper, aluminium pipes and profiles. Cuts through embedded nails in wood up to 5mm in diameter and even masonry, like porous concrete.

**WOOD WOOD&NAILS**

8 Sets in End-cap display (minimum order 8 sets)



PACK Quantity	MATERIAL	W mm	I mm	TPI		ORDER NO.
1	HCS	34	40	14	8	<b>OMM04-X1</b>
1	HCS	68	40	14	8	<b>OMM06-X1</b>
1	BIM	32	40	18	8	<b>OMM12-X1</b>
1	BIM	45	48	18	8	<b>OMM15-X1</b>

### OMM-X33

Universal Arbor



#### 33 piece Multipurpose Set for Oscillating Multi-tools

- blades for cutting wood, plastic, drywall, sheet metal, profiles and tubing in aluminum and copper.
- scraper to remove carpet adhesive/glue residues as well as paint and silicone residues.
- sanding pad and sanding sheets for sanding (60, 100, and 180 grit).

Pack Quantity	W mm	I mm	TPI	GRIT		ORDER NO.
1	32	40	18		10	<b>OMM12-X1</b>
1	52	45			10	<b>OMM20-X1</b>
1	93				10	<b>OMM30-X1</b>
10	93			60	10	<b>OMA30060-X10</b>
10	93			100	10	<b>OMA30100-X10</b>
10	93			180	10	<b>OMA30180-X10</b>

### OMM-X37

Universal Arbor



Front



Back

#### 37 piece Multipurpose Set for Oscillating Multi-Tools

- blades (in two sizes) for making cuts in wood, plastic, drywall, sheet metal, profiles and tubing in aluminum and copper.
- segmented blade for cutting wood and metal.
- scraper for removing carpet adhesive/glue residues as well as paint and varnish residues.
- rasp in carbide for grinding/sanding/removal of tiles, drywall, and cement, wood and building materials.
- specially designed blade to remove mortar, cementitious materials, cement and stone, even in hard to reach corners.
- sanding pad and sanding sheets (60, 100, 180 grit).

Pack Quantity	W mm	I mm	TPI	GRIT		ORDER NO.
1	10	28	18		10	<b>OMM09-X1</b>
1	32	40	18		10	<b>OMM12-X1</b>
1	87		20		10	<b>OMM17-X1</b>
1	52	45			10	<b>OMM20-X1</b>
1	80				10	<b>OMM25-X1</b>
1	65				10	<b>OMM29-X1</b>
1	93				10	<b>OMM30-X1</b>
10	93			60	10	<b>OMA30060-X10</b>
10	93			100	10	<b>OMA30100-X10</b>
10	93			180	10	<b>OMA30180-X10</b>



# TOOLS WITH BORE & KNIVES

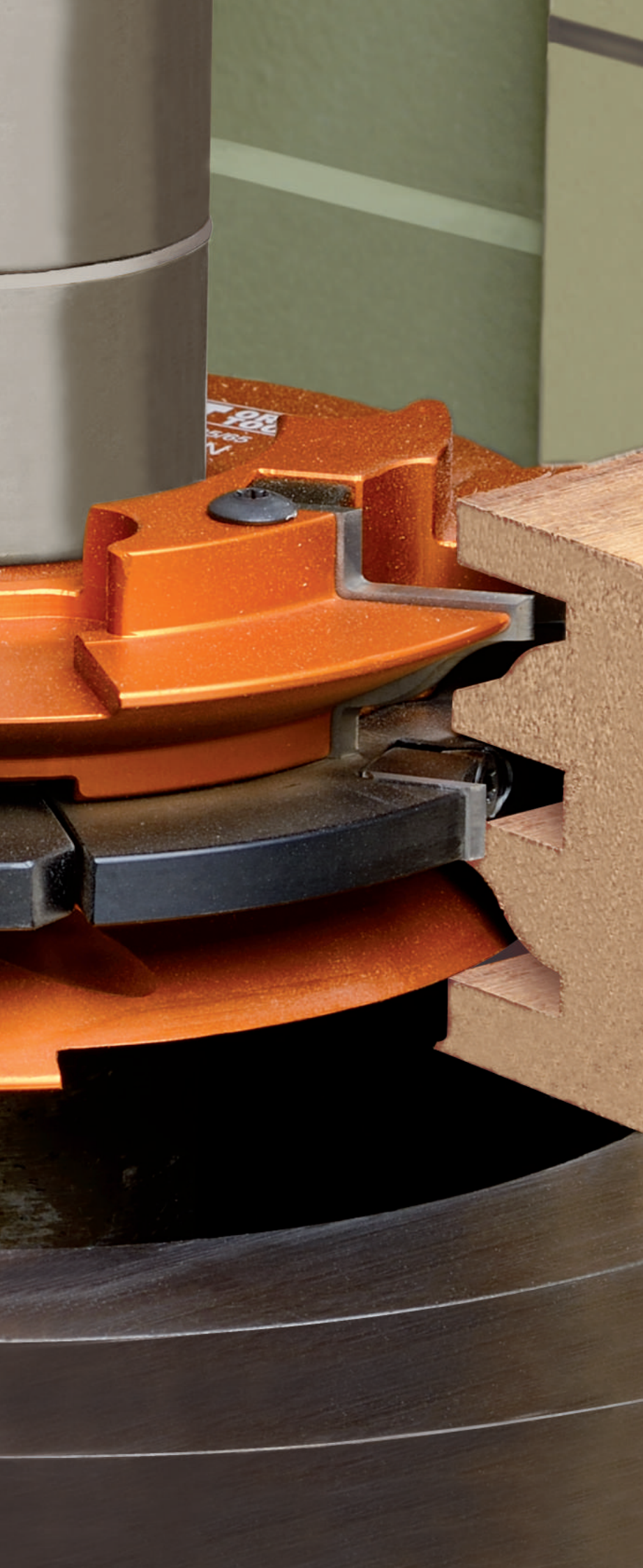

<b>PRODUCTS</b>	<b>PAGE</b>
Rabbeting Cutter Heads	96-97
Adjustable Grooving Set	98-99
Planing & Jointing Spiral Cutter Heads	100
2 piece Adjustable Rounding & Chamfering Set	101
Chamfer Cutter Heads	102-103
Multiradius Roundover Cutter Heads	104-106
Jointing Cutter Heads	107-109
Panel Cutter Heads	110-114
Cutter Heads for Universal Knives & Sets	115-117
Profile Knives & Limiters	118-131
Blank Knives & Limiters (to be sharpened)	132
Bore Reducers	132
HS Corrugated Back Moulder Knives	133
Magnetic Knife Setting Jigs	133
Planer & Jointer Knives	134-135
HWM Reversible Knives	136-137
HWM Reversible Knives for Portable Planers	138





## 694.100



These cutter heads have been designed for:

- rabbeting from either top or bottom;
- jointing
- grooving

For use on spindle moulder machines, double-end tenoner and edging machines.

Suitable for all materials, but best on chipboard, MDF, wood composites, plastic materials and laminates. Improved design with shear angle.

### TECHNICAL DETAILS:

- Hard aluminium alloy body with high resistance to tensile and yield stress.
- 2 universal HWM straight knives 50x12x1,5mm [Z2], 1 up cut - 1 down cut.
- 4 universal HWM scoring knives 14x14x2mm [V4].
- Tools for manual feed (MAN).
- Pins for automatic positioning of the knives.

Supplied in a solid plastic box.

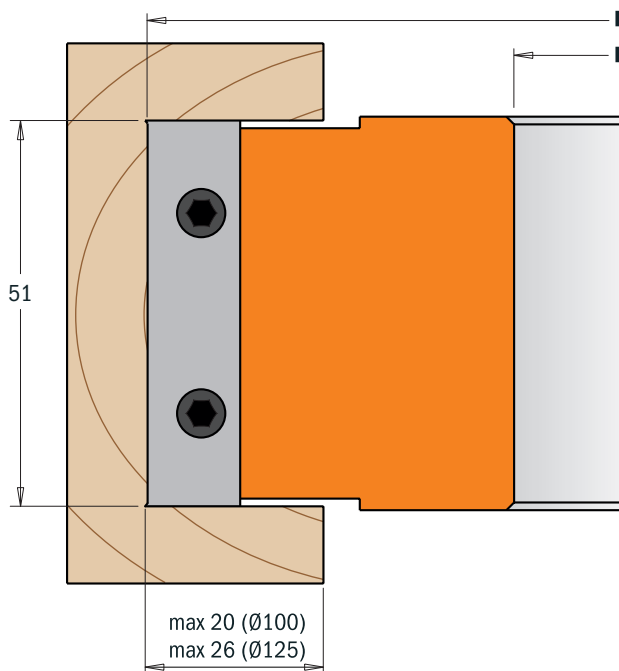
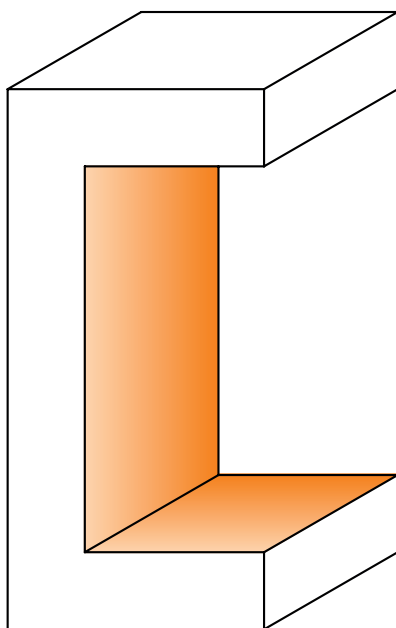
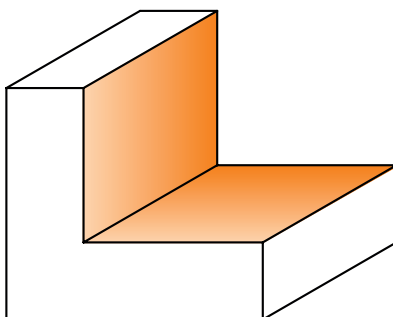
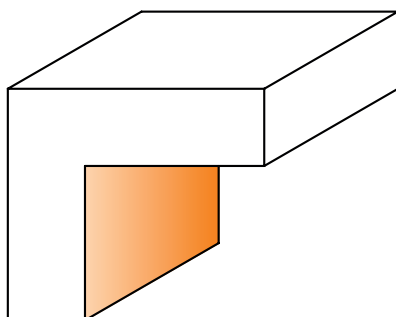

Drawing is 1:1 scale

D mm	B mm	I mm	Z+V	RPM		ORDER NO.	Spare parts													
100	19,05	51	2+4	7500~12500	1	<b>694.100.19</b>														
100	30	51	2+4	7500~12500	1	<b>694.100.30</b>	790.140.00	990.093.00	991.073.00	790.500.00	695.999.46	990.064.00	991.064.00	790.140.00	990.093.00	991.073.00	790.500.00	695.999.46	990.064.00	991.064.00
100	31,75	51	2+4	7500~12500	1	<b>694.100.31</b>	790.140.00	990.093.00	991.073.00	790.500.00	695.999.46	990.064.00	991.064.00	790.140.00	990.093.00	991.073.00	790.500.00	695.999.46	990.064.00	991.064.00
100	35	51	2+4	7500~12500	1	<b>694.100.35</b>	790.140.00	990.093.00	991.073.00	790.500.00	695.999.46	990.064.00	991.064.00	790.140.00	990.093.00	991.073.00	790.500.00	695.999.46	990.064.00	991.064.00
125	40	51	2+4	6100~10000	1	<b>694.125.40</b>	790.140.00	990.093.00	991.073.00	790.500.00	695.999.46	990.064.00	991.064.00	790.140.00	990.093.00	991.073.00	790.500.00	695.999.46	990.064.00	991.064.00
125	50	51	2+4	6100~10000	1	<b>694.125.50</b>	790.140.00	990.093.00	991.073.00	790.500.00	695.999.46	990.064.00	991.064.00	790.140.00	990.093.00	991.073.00	790.500.00	695.999.46	990.064.00	991.064.00

790.140.00 and 790.500.00 are supplied in 10-piece pack or multiple

# Cutter Heads for Rabbeting with 40mm Profile Knives



## 694.020

These cutter heads have been designed for:

- rabbeting from either top or bottom;
- jointing
- grooving
- 40mm SP profile knives

For use on spindle moulder machines, double-end tenoners and edging machines.

Suitable for all materials, but best on chipboard, MDF, wood composites, plastic materials and laminates.



### TECHNICAL DETAILS:

- Hard aluminium alloy body with high resistance to tensile and yield stress.
- 2 universal HWM straight knives 40x12x1,5mm [Z2].
- 2 universal HWM scoring knives 14x14x2mm [V2].
- Tools for manual feed (MAN).
- Pins for the automatic positioning of the knives.

Supplied in a solid plastic box.

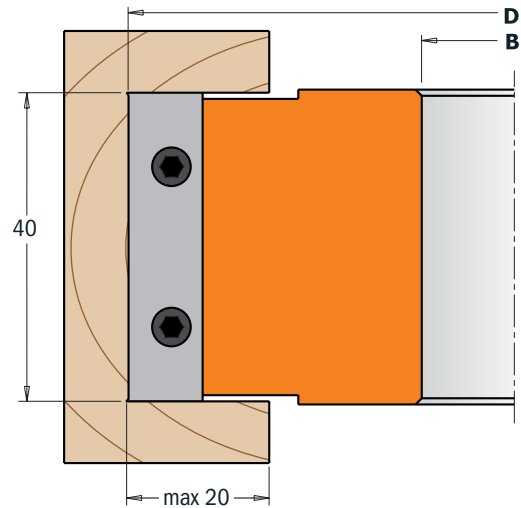
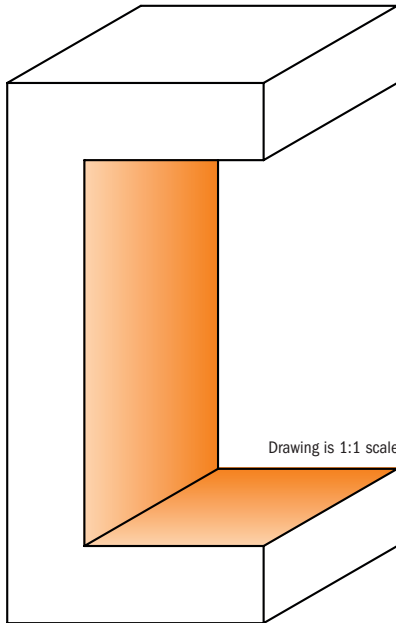
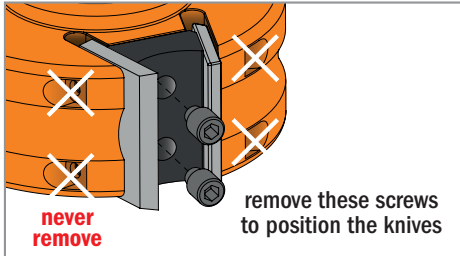

To use with all 40mm profile knives  
(refer to pages 118 to 127)

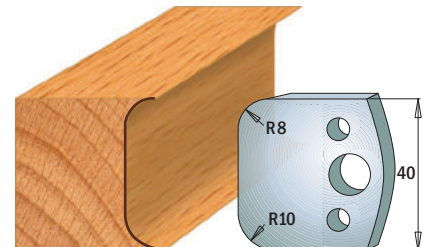
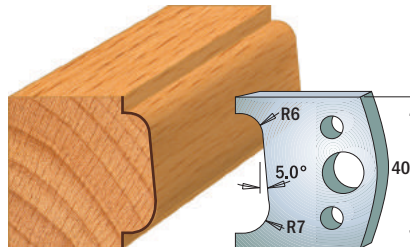
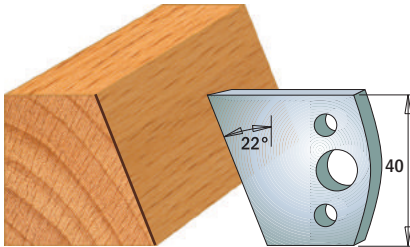

D mm	B mm	I mm	Z+V	RPM	Box	ORDER NO.	Spare parts						
100	30	40	2+2	7500~12500	1	<b>694.020.30</b>							
100	31,75	40	2+2	7500~12500	1	<b>694.020.31</b>	790.140.00	990.093.00	991.073.00	790.400.00	693.999.01	990.065.00	991.064.00
125	35	40	2+2	7500~12500	1	<b>694.020.35</b>	790.140.00	990.093.00	991.073.00	790.400.00	693.999.01	990.065.00	991.064.00
125	40	40	2+2	7500~12500	1	<b>694.020.40</b>	790.140.00	990.093.00	991.073.00	790.400.00	693.999.01	990.065.00	991.064.00
125	50	40	2+2	7500~12500	1	<b>694.020.50</b>	790.140.00	990.093.00	991.073.00	790.400.00	693.999.01	990.065.00	991.064.00

Spare parts 691.192 Pair of limiters 40x4mm  
695.020.01 Indexable knife edge block 38x4x15mm

790.140.00 and 790.400.00 are supplied in 10-piece pack or multiple



# 3 piece Adjustable Grooving Sets



**694.001**

These cutter heads are the ideal tools to create precision slots and grooves on material 4 to 15mm deep.

- 2 cutter heads type (A) [Z4 + V4]
- 1 cutter head type (B) [Z2]
- 12 spacer rings from 0,1 to 2mm

For use on your spindle moulder machines, double-end tenoner and shaper machines. Perfect grooving on all materials, but ideal on solid wood, plywood and laminated panels.

**TECHNICAL DETAILS:**

- Super-strength steel body.
- 2 HWM Knives 7,65x12x1,5mm [Z2].
- 4 HWM Knives 18x18x1,95mm [Z4].
- 4 HWM Knives 14x14x1,2mm [V4].
- Tools for manual feed (MAN).
- Pins for automatic positioning of the knives.

Supplied in a solid plastic box.

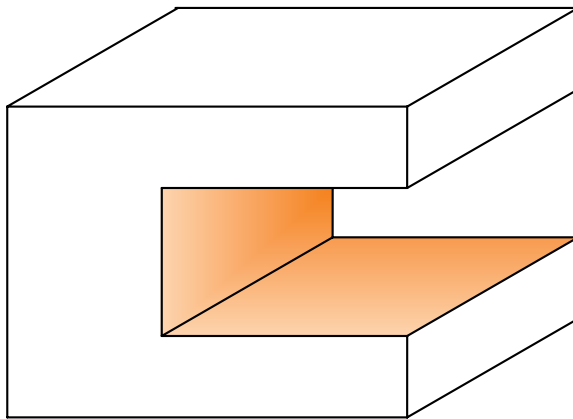
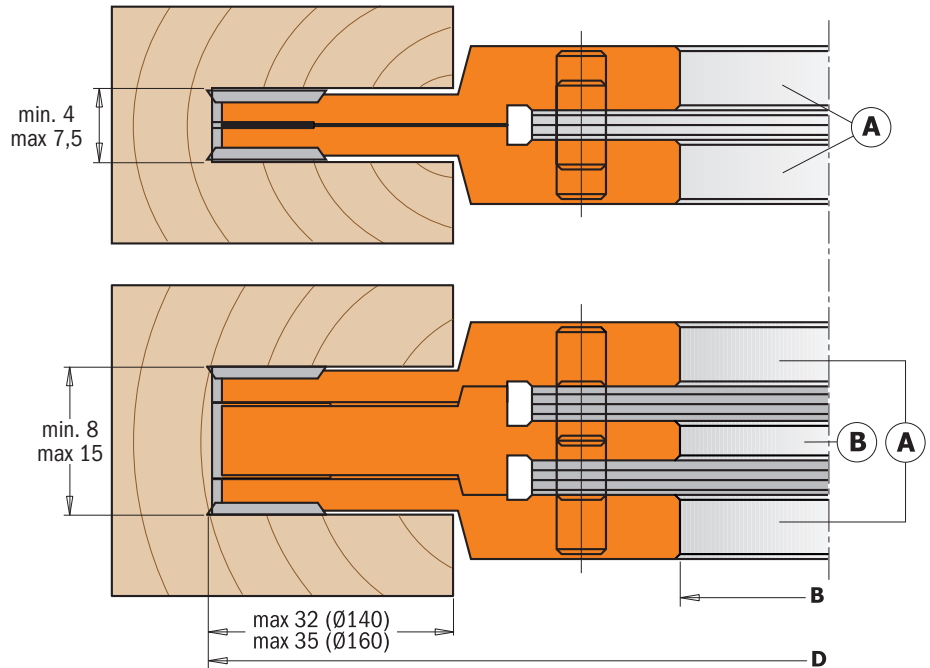



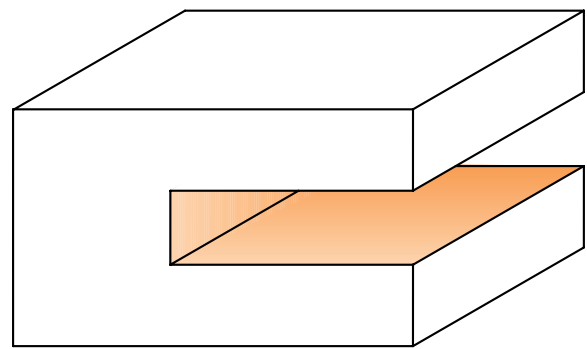

Drawing is 1:1 scale



D mm	B mm	Z+V	RPM		ORDER NO.
140	30	4+4	5500~9500	1	<b>694.001.30</b>
140	31,75	4+4	5500~9500	1	<b>694.001.31</b>
140	35	4+4	5500~9500	1	<b>694.001.35</b>
160	40	4+4	4800~8300	1	<b>694.001.40</b>
160	50	4+4	4800~8300	1	<b>694.001.50</b>

*Spare parts*

			
790.181.00	790.140.10	790.076.00	695.998.21
790.181.00	790.140.10	790.076.00	695.998.22
790.181.00	790.140.10	790.076.00	695.998.23
790.181.00	790.140.10	790.076.00	695.998.24N
790.181.00	790.140.10	790.076.00	695.998.25N

*Spare parts*

**For cutter heads (A)**

- 990.079.00 M4x3,2mm Torx screws
- 991.069.00 T9 Torx key
- 695.996.02 M4 (Ø12x1,7mm) threaded ring
- 695.996.01 M4 (Ø10x1,6mm) threaded ring

**For cutter heads (B)**

- 695.999.07 7x11x9,5mm wedge for knives
- 990.063.00 M5x18mm screw
- 991.072.00 T20 Torx key

790.181.00, 790.140.10 and 790.076.00 are supplied in 10-piece pack or multiple

# 2 Piece Adjustable Grooving Sets



## 694.021 - 694.022



These cutter heads are the ideal tools to create precision slots and grooves on material from 14 to 39mm deep. These sets include:

- 1 cutter head type (A) [Z2 + V2]
- 1 cutter head type (B) [Z2 + V2]
- spacer rings set

For use on spindle moulder machines, double-end tenoners and shaper machines. Perfect grooving on all materials, but ideal on solid wood, plywood and laminated panels.

### 299 Spacer Rings (Optional)

ORDER NO.	B mm	D mm	P mm
299.560.30	30	60	5
299.560.31	31,75	60	5
299.560.35	35	60	5
299.560.40	40	60	5
299.560.50	50	70	5

Ring for thickness above 14mm (9/16")

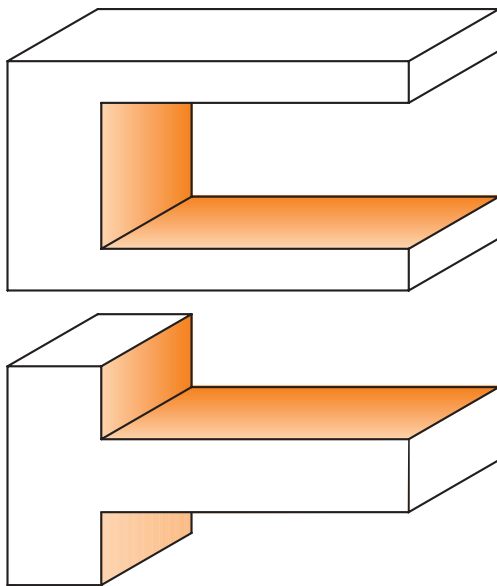
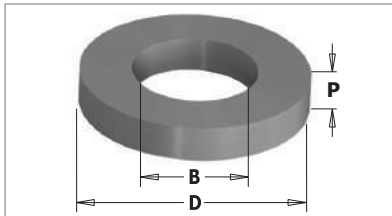

Drawing is 1:1 scale

#### TECHNICAL DETAILS:

- Super-strength hard aluminium alloy body.
- **694.021:** 8 HWM knives 13,6x13,6x2mm.
- **694.022:** 4 HWM knives 19,5x12x1,5mm.  
4 HWM knives 14x14x2mm.
- Tools for manual feed (MAN).
- Pins for the automatic positioning of the knives.

Supplied in a solid plastic box.

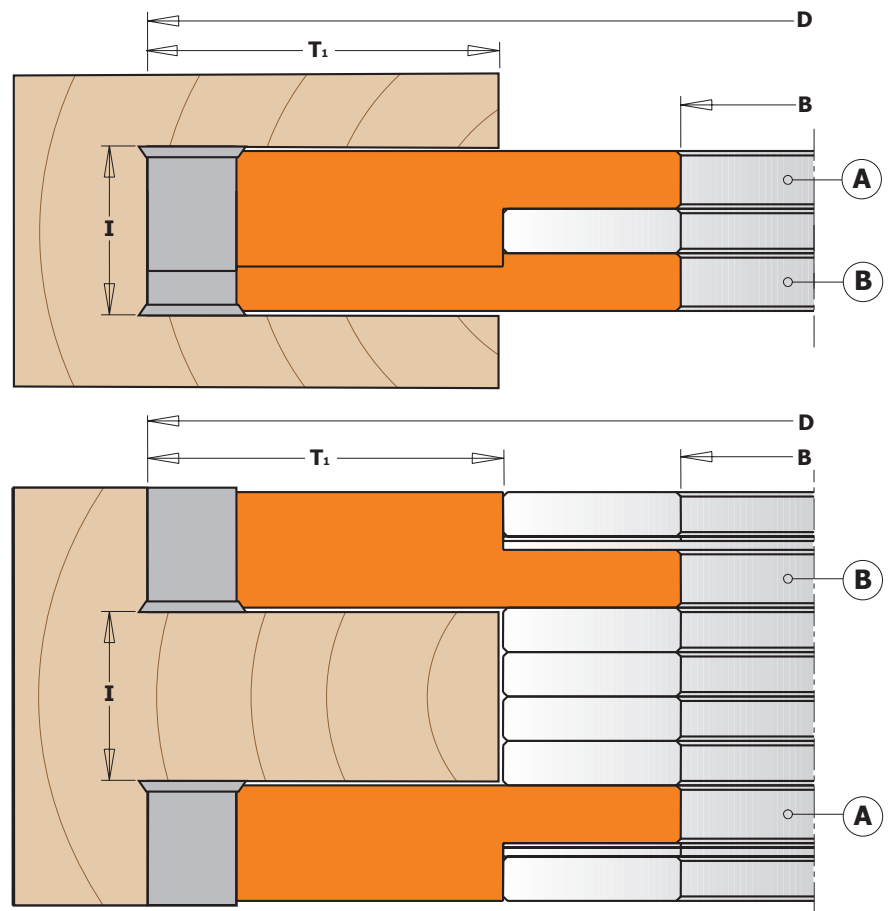

D mm	I mm	B mm	T <sub>1</sub> mm	Z+V	RPM		ORDER NO.	Spare parts						
150	14-27	30	44	4+4	5000~8000	1	<b>694.021.30</b>	790.136.00	990.093.00					695.998.41
150	14-27	31,75	44	4+4	5000~8000	1	<b>694.021.31</b>	790.136.00	990.093.00					695.998.42
150	14-27	35	44	4+4	5000~8000	1	<b>694.021.35</b>	790.136.00	990.093.00					695.998.43
150	14-27	40	44	4+4	5000~8000	1	<b>694.021.40</b>	790.136.00	990.093.00					695.998.44
160	14-27	50	44	4+4	5000~8000	1	<b>694.021.50</b>	790.136.00	990.093.00					695.998.45
170	20-39	30	54	4+4	4400~7400	1	<b>694.022.30</b>	790.140.00	990.093.00	790.195.12	990.094.00			695.998.46
170	20-39	31,75	54	4+4	4400~7400	1	<b>694.022.31</b>	790.140.00	990.093.00	790.195.12	990.094.00			695.998.47
170	20-39	35	54	4+4	4400~7400	1	<b>694.022.35</b>	790.140.00	990.093.00	790.195.12	990.094.00			695.998.48
170	20-39	40	54	4+4	4400~7400	1	<b>694.022.40</b>	790.140.00	990.093.00	790.195.12	990.094.00			695.998.49
170	20-39	50	49	4+4	4400~7400	1	<b>694.022.50</b>	790.140.00	990.093.00	790.195.12	990.094.00			695.998.50

Spare parts 991.072.00 T20 Torx key  
991.073.00 T25 Torx key

790.136.00, 790.140.00 and 790.195.12 are supplied in 10-piece pack or multiple



## 694.019

These new cutter heads have been designed for planing and jointing on soft or hard wood and wooden boards on spindle moulder machines. Ideal for routing curved elements with the aid of a bearing guide (sold separately) and a template.

### TECHNICAL DETAILS:

- Hard aluminium alloy body with high resistance to tensile and yield stress.
- 12 HWM Knives 14x14x2mm [Z2] with 4 spiral indexing.
- Tools for manual feed (MAN).

Supplied in a plastic twistpack.

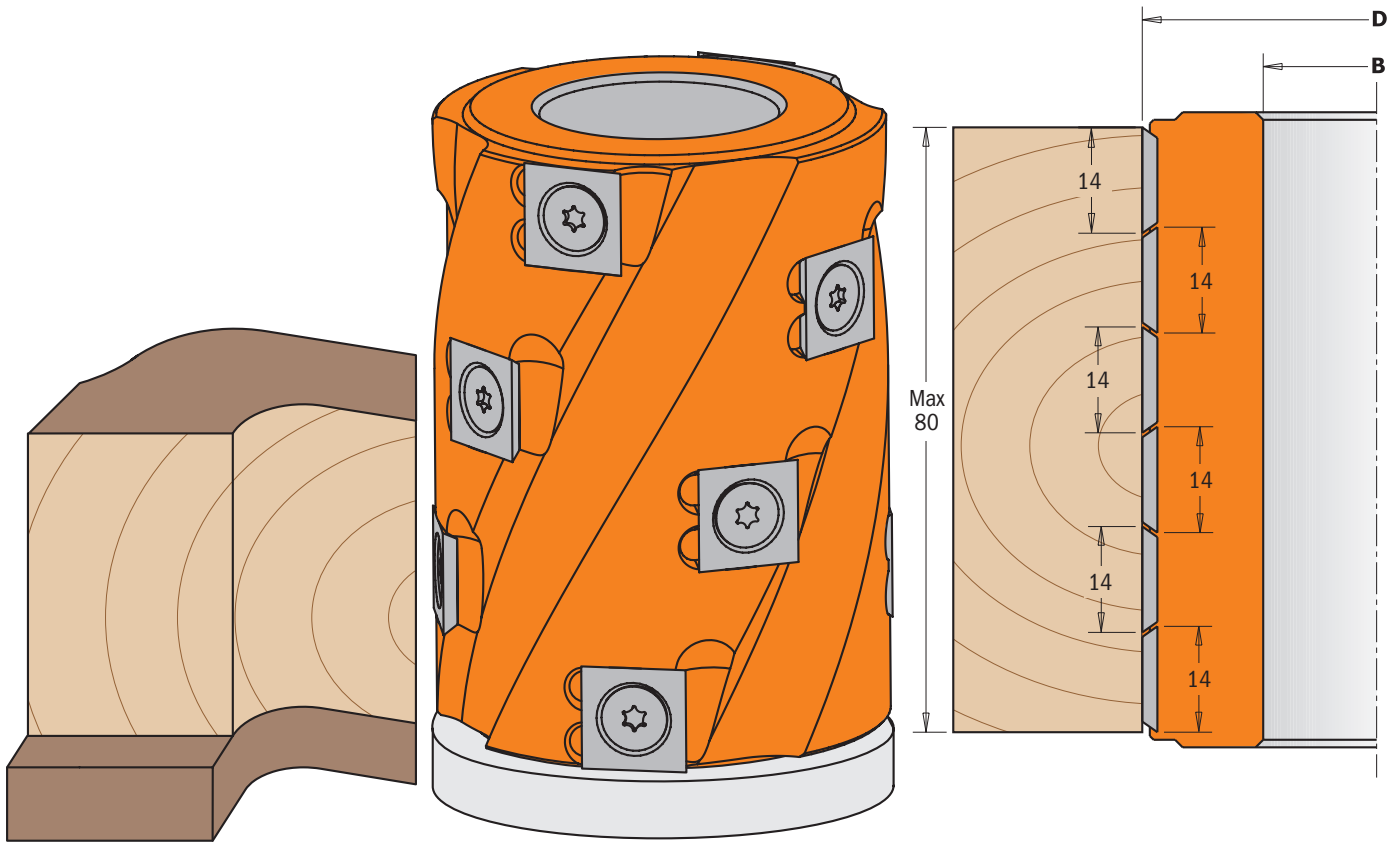

Optional bearing

D mm	I mm	B mm	Z	RPM		ORDER NO.	Spare parts		
62	80	30	12	8000~12000	1	<b>694.019.30</b>			
62	80	35	12	8000~12000	1	<b>694.019.35</b>	790.140.00	990.093.00	991.073.00
80	80	40	12	8000~12000	1	<b>694.019.40</b>	790.140.00	990.093.00	991.073.00
80	80	50	12	8000~12000	1	<b>694.019.50</b>	790.140.00	990.093.00	991.073.00

**Optional**

791.051.00	30x62x16mm bearing
791.052.00	35x62x14mm bearing
791.054.00	40x80x18mm bearing
791.053.00	50x80x16mm bearing

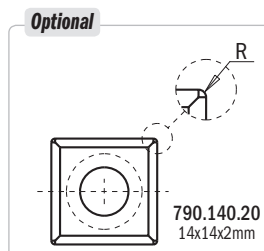

**NOTE:** In order to achieve an extra-fine finish, you can order the optional knife 790.140.20

790.140.00 and 790.140.20 are supplied in 10-piece pack or multiple



# 2 Piece Adjustable Rounding & Chamfering Sets

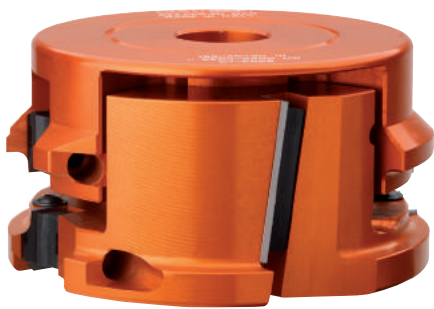

## 694.005



Innovative design, simple assembly and countless possibilities. The CMT adjustable rounding and chamfering sets consist of two pieces, which are very easy to set up on your spindle moulder machine, allowing you to profile on solid wood and synthetic boards (with or without coating). Includes five different knives for rounding over top and bottom edges in one single pass with a radius of 2,3,4,5 or 6mm and for 45° chamfering on material 18mm to 50mm in thickness.

The improved design with shear angle guarantees perfect finishing! For use on spindle moulder machines and double-end tenoners.

### TECHNICAL DETAILS:

- Hard aluminium alloy body with high resistance to tensile and yield stress.
- One pair of HWM top knives radius 4mm and 45° chamfer (20x20,5x2mm) [Z2].
- One pair of HWM bottom knives radius 4mm and 45° chamfer (20x20,5x2mm) [Z2].
- Two HWM knives 50x12x1,5mm.
- Set of 21 spacer rings from 0,1 to 3mm.
- Tools for manual feed (MAN).
- Pins for the automatic positioning of the knives.

Supplied in a solid plastic box.

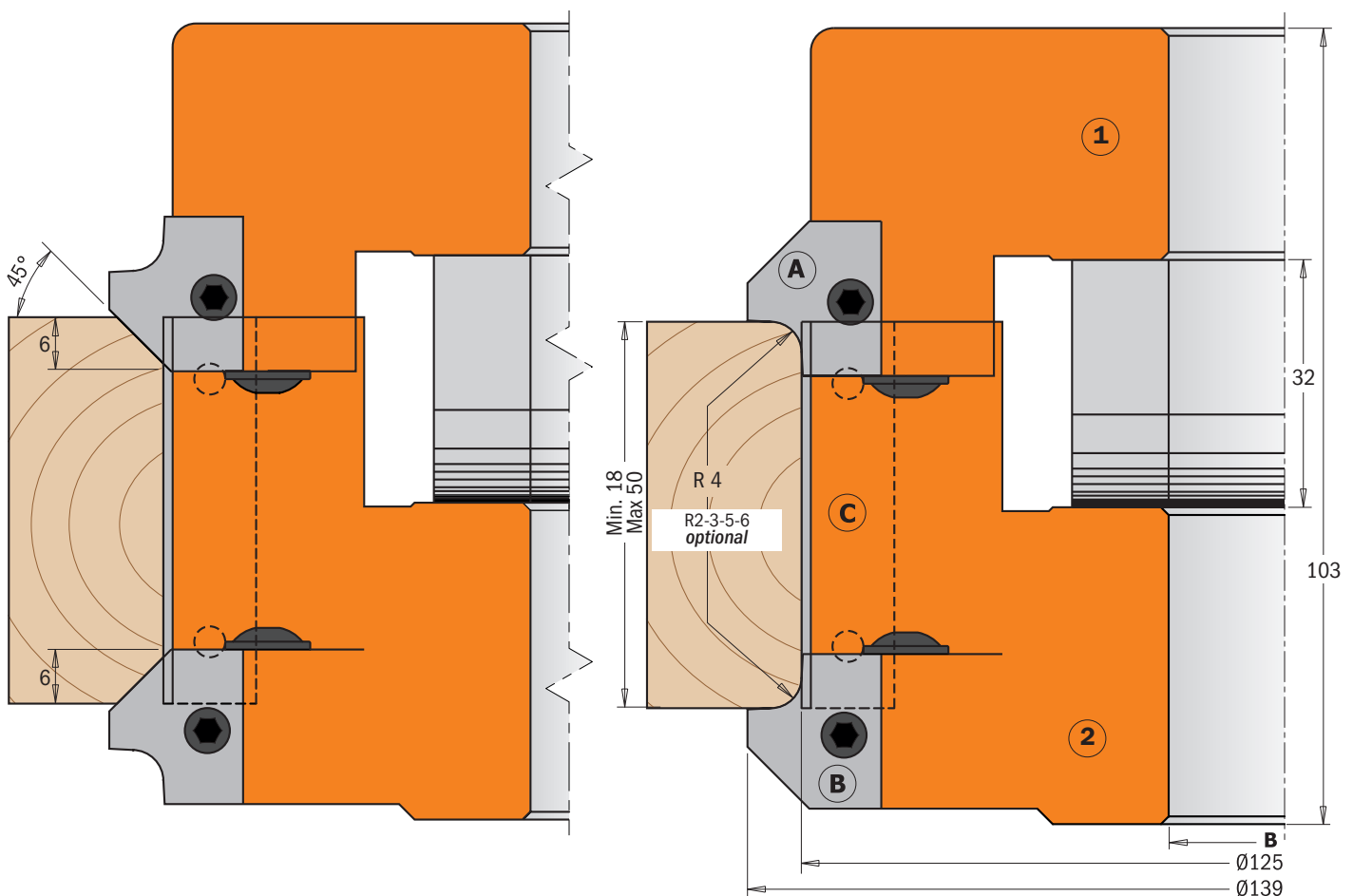

D mm	B mm	Z	RPM		ORDER NO.
139	30	2+2	5500~9400	1	<b>694.005.30</b>
139	31,75	2+2	5500~9400	1	<b>694.005.31</b>
139	35	2+2	5500~9400	1	<b>694.005.35</b>
139	40	2+2	5500~9400	1	<b>694.005.40</b>
139	50	2+2	5500~9400	1	<b>694.005.50</b>

### Spare parts

17x11x9,5mm	46x11x9,5mm		
695.999.17	695.999.46	990.064.00	695.998.11
695.999.17	695.999.46	990.064.00	695.998.12
695.999.17	695.999.46	990.064.00	695.998.13
695.999.17	695.999.46	990.064.00	695.998.14
695.999.17	695.999.46	990.064.00	695.998.15

### Spare parts

695.005.A4	R=4+45° pair of knives for roundover/chamfer (top)
695.005.B4	R=4+45° pair of knives for roundover/chamfer (bottom)
790.500.00	50x12x1,5mm knives
991.064.00	4mm hex key
991.067.00	3mm hex key

### Optional

695.005.A2	R=2+45° pair of knives for roundover/chamfer (top)
695.005.A3	R=3+45° pair of knives for roundover/chamfer (top)
695.005.A5	R=5+45° pair of knives for roundover/chamfer (top)
695.005.A6	R=6+45° pair of knives for roundover/chamfer (top)
695.005.B2	R=2+45° pair of knives for roundover/chamfer (bottom)
695.005.B3	R=3+45° pair of knives for roundover/chamfer (bottom)
695.005.B5	R=5+45° pair of knives for roundover/chamfer (bottom)
695.005.B6	R=6+45° pair of knives for roundover/chamfer (bottom)

# 45° Chamfer Cutter Heads



## 694.002

CMT chamfer cutter heads carry out clean accurate bevels and joints for excellent edge work. For use on spindle moulder machines, double-end tenoner and shaper machines. Suitable for all materials, but ideal on solid wood, veneer, plywood and laminated materials.

### TECHNICAL DETAILS:

- Hard aluminium alloy body with high resistance to tensile and yield stress.
- 2 HWM Knives 50x12x1,5mm [Z2].
- Tools for manual feed (MAN).
- Pins for the automatic positioning of the knives.

Supplied in a solid plastic box.

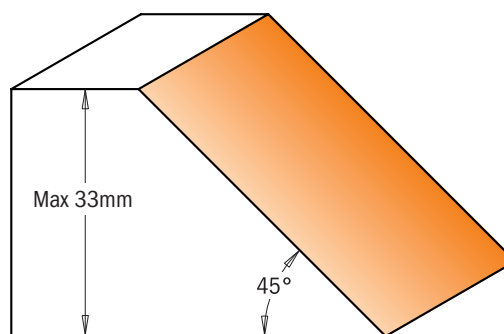
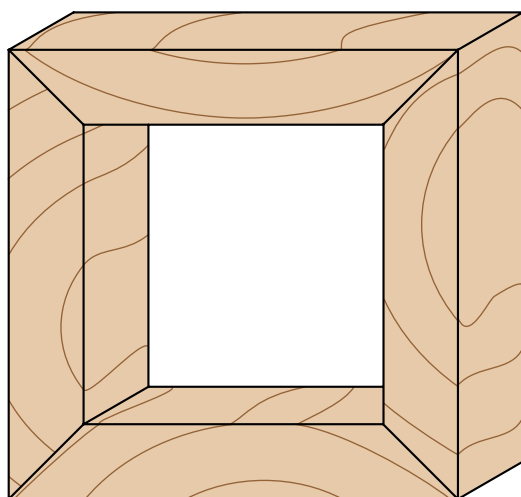
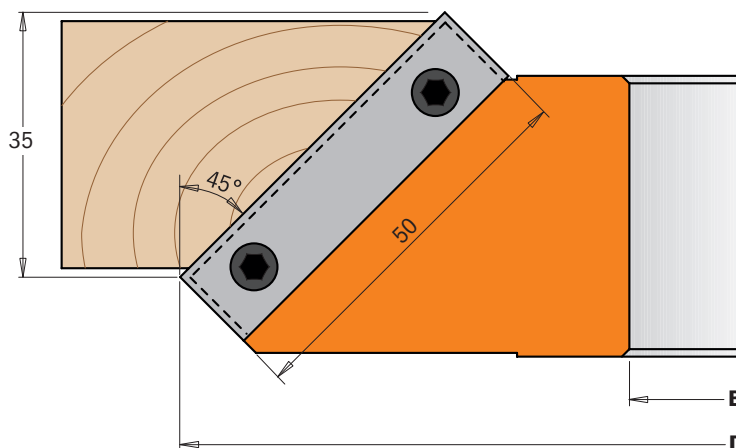

Drawing is 1:1 scale

D mm	B mm	Z	RPM		ORDER NO.
150	30	2	5100~8800	1	<b>694.002.30</b>
150	31,75	2	5100~8800	1	<b>694.002.31</b>
150	35	2	5100~8800	1	<b>694.002.35</b>
150	40	2	5100~8800	1	<b>694.002.40</b>
160	50	2	4800~8300	1	<b>694.002.50</b>

### Spare parts

790.500.00	695.999.42	990.064.00	991.064.00
790.500.00	695.999.42	990.064.00	991.064.00
790.500.00	695.999.42	990.064.00	991.064.00
790.500.00	695.999.42	990.064.00	991.064.00
790.500.00	695.999.42	990.064.00	991.064.00

790.500.00 are supplied in 10-piece pack or multiple

# Adjustable Chamfer Cutter Heads with Positive Stop



## 694.018

This chamfer cutter head carries out very precise cuts on wooden boards and solid timber. It also crafts gap-free bevel joints and is the perfect tool for a variety of joinery projects. For use on spindle moulding machines, double-end tenoners and shaper machines.



### TECHNICAL DETAILS:

- Tool body made from high strength aluminum alloy extremely resistant to tensile and yield stress
- Manual feed tool (MAN)
- 2 HWM knives 40x12x1,5mm[Z2]
- Adjustable swivelling blades
- Range:  $\pm 45^\circ$  (Rotates at  $7,5^\circ$  intervals; Precision =  $7,5^\circ$ )

Supplied in a solid plastic box.

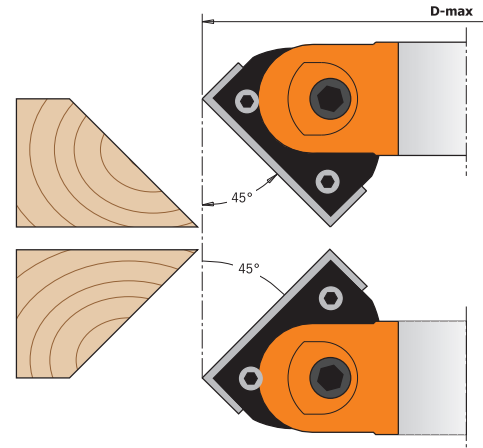
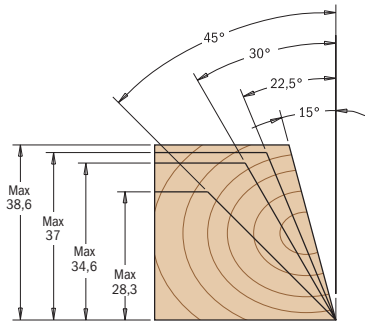
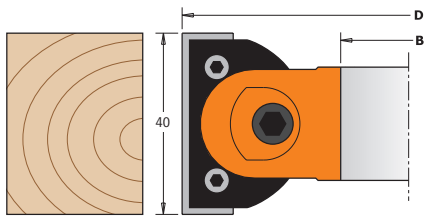

D mm	I mm	B mm	Z	D_Max 45° mm	RPM		ORDER NO.	Spare parts							
120	40	30	2	140	7000~9000	1	<b>694.018.30</b>					695.018.01	790.400.00	990.094.00	991.072.00
120	40	35	2	140	7000~9000	1	<b>694.018.35</b>	695.018.01	790.400.00	990.094.00	991.072.00	695.018.01	790.400.00	990.094.00	991.072.00
145	40	40	2	165	4800~7200	1	<b>694.018.40</b>	695.018.01	790.400.00	990.094.00	991.072.00	695.018.01	790.400.00	990.094.00	991.072.00
145	40	50	2	165	4800~7200	1	<b>694.018.50</b>	695.018.01	790.400.00	990.094.00	991.072.00	695.018.01	790.400.00	990.094.00	991.072.00

Spare parts 991.065.00 5mm hex key

790.400.00 are supplied in 10-piece pack or multiple

# Professional Adjustable Chamfer Cutter Heads with Gear Box

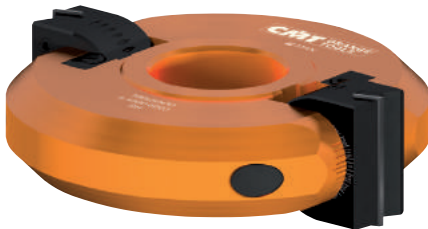

## 694.017

These new professional adjustable chamfer cutter heads carry out precise cuts, accurate bevels and joints on wooden boards and solid timber. For use on spindle moulder machines, double-end tenoner and shaper machines.



### TECHNICAL DETAILS:

- Tool body made from high strength aluminum alloy extremely resistant to tensile and yield stress
- Manual feed tool (MAN)
- 2 HWM knives 50x12x1,5mm [Z2]
- Adjustable swivelling blades
- Range  $\pm 90^\circ$  (Rotates at  $7,5^\circ$  intervals; Precision =  $7,5^\circ$ )

Supplied in a solid plastic box.

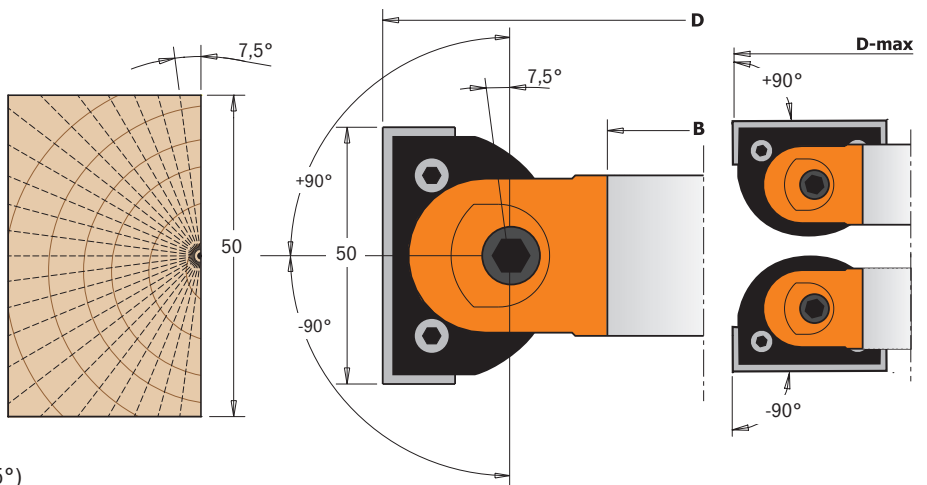

D mm	I mm	B mm	Z	D_Max 45° mm	RPM		ORDER NO.	Spare parts									
160	50	30	2	183	4800~6000	1	<b>694.017.30</b>					695.017.01	790.500.00	695.999.48	990.106.00	991.067.00	
160	50	35	2	183	4800~6000	1	<b>694.017.35</b>	695.017.01	790.500.00	695.999.48	990.106.00	991.067.00	695.017.01	790.500.00	695.999.48	990.106.00	991.067.00
160	50	50	2	183	4800~6000	1	<b>694.017.50</b>	695.017.01	790.500.00	695.999.48	990.106.00	991.067.00	695.017.01	790.500.00	695.999.48	990.106.00	991.067.00

Spare parts 991.081.00 4mm hex key

790.500.00 are supplied in 10-piece pack or multiple



# Multiradius Roundover Cutter Heads



## 694.003

Innovative cutter heads supporting three different knives for making six radius roundover profiles. Standard cutter heads are sold with knives featuring 5 and 10mm radii; two more knife sets are available for radii 4-8mm and 3-6mm. For use on spindle moulder machines, double-end tenoner and shaper machines. Suitable for all materials, but ideal on solid wood and panel materials.

### TECHNICAL DETAILS:

- Hard aluminium alloy body with high resistance to tensile and yield stress.
- 2 HWM knives radius 5/10mm (25x24,8x2mm) [Z2].
- Tools for manual feed (MAN).
- Pins for the automatic positioning of the knives.

Supplied in a solid plastic box.

### Standard

Pair of knives **695.003.05**

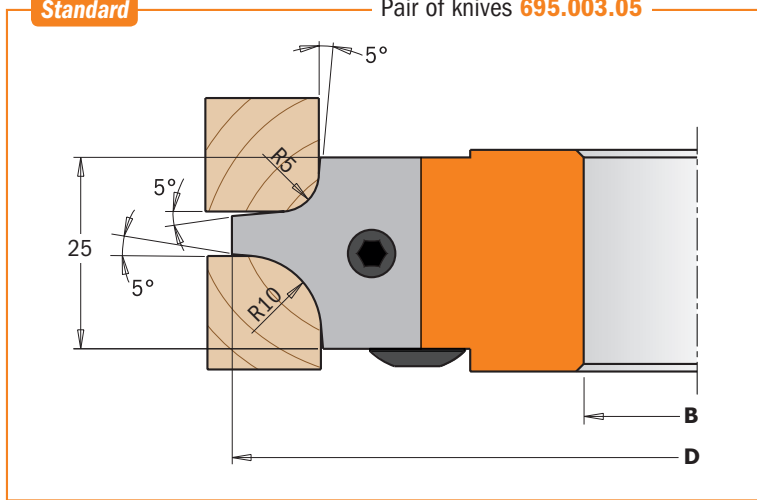

### Optional

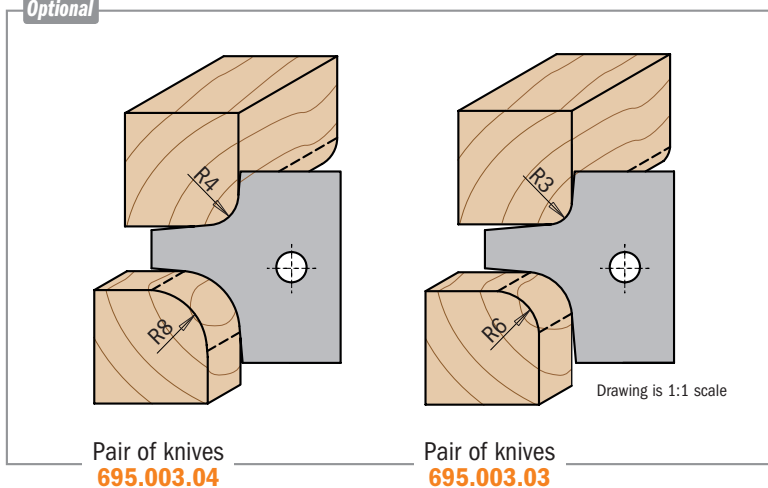

Pair of knives  
**695.003.04**

Pair of knives  
**695.003.03**

D mm	B mm	Z	RPM		ORDER NO.
113	30	2	6700~11000	1	<b>694.003.30</b>
113	31,75	2	6700~11000	1	<b>694.003.31</b>
113	35	2	6700~11000	1	<b>694.003.35</b>
128	40	2	5900~9700	1	<b>694.003.40</b>
128	50	2	5900~9700	1	<b>694.003.50</b>

### Spare parts

x2			
695.003.05	695.999.22	990.064.00	991.064.00
695.003.05	695.999.22	990.064.00	991.064.00
695.003.05	695.999.22	990.064.00	991.064.00
695.003.05	695.999.22	990.064.00	991.064.00
695.003.05	695.999.22	990.064.00	991.064.00

<b>Optional</b>	695.003.04	R=4/8mm (25x24,8x2mm) pair of profiled knives
	695.003.03	R=3/6mm (25x24,8x2mm) pair of profiled knives

# Multiradius Roundover Cutter Heads



## 694.004

Innovative cutter heads supporting two different knives for making four radius roundover profiles. Standard cutter heads are sold with knives featuring radii 15 and 20mm; one more knife set is available for radii 12-18mm. For use on spindle moulder machines, double-end tenoner and shaper machines. Suitable for all materials, but ideal on solid wood and panel materials.



### TECHNICAL DETAILS:

- Hard aluminium alloy body with high resistance to tensile and yield stress.
- 2 HWM knives radius 15/20mm (45x34,5x2mm) [Z2].
- Tools for manual feed (MAN).
- Pins for the automatic positioning of the knives.

Supplied in a solid plastic box.

### Standard

Pair of knives **695.004.15**

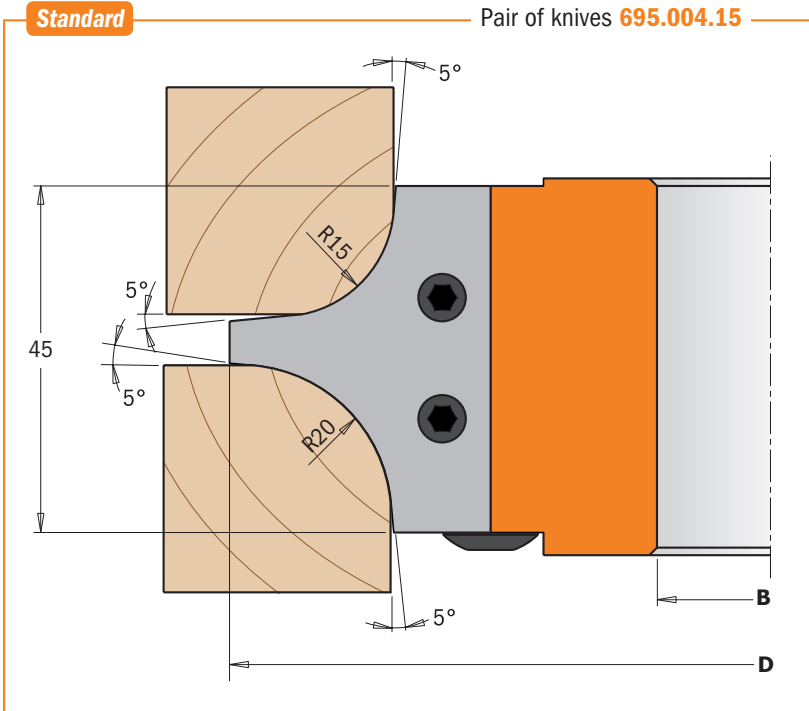

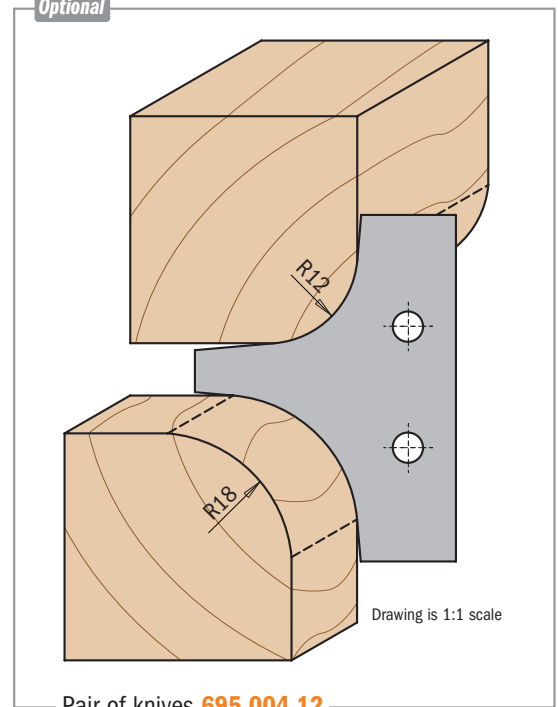

### Optional



Pair of knives **695.004.12**

D mm	B mm	Z	RPM		ORDER NO.
132	30	2	5700~9500	1	<b>694.004.30</b>
132	31,75	2	5700~9500	1	<b>694.004.31</b>
132	35	2	5700~9500	1	<b>694.004.35</b>
147	40	2	5100~8500	1	<b>694.004.40</b>
147	50	2	5100~8500	1	<b>694.004.50</b>

### Spare parts

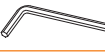
 x2			
695.004.15	695.999.42	990.064.00	991.064.00
695.004.15	695.999.42	990.064.00	991.064.00
695.004.15	695.999.42	990.064.00	991.064.00
695.004.15	695.999.42	990.064.00	991.064.00
695.004.15	695.999.42	990.064.00	991.064.00

**Optional** 695.004.12 R=12/18mm (45x34,5x2mm) pair of profiled knives



## 694.007

These cutter heads are perfect for making furniture, doors and drawer fronts simply and stylishly by giving them a final touch with a CMT cove bit. It is also used for making perfect roundover profiles, drop leaf counters and table tops. You can use three different knives for carrying out roundover and cove profiles with radius 10, 12 and 15mm. For use on spindle moulder machines, double-end tenoner and shaper machines. Suitable for all materials, but ideal on solid wood and panel materials.

### TECHNICAL DETAILS:

- Hard aluminium alloy body with high resistance to tensile and yield stress.
- 2 HWM knives radius 10mm (34,8x29,3x2mm) [Z2].
- Tools for manual feed (MAN).
- Pins for the automatic positioning of the knives.

Supplied in a solid plastic box.

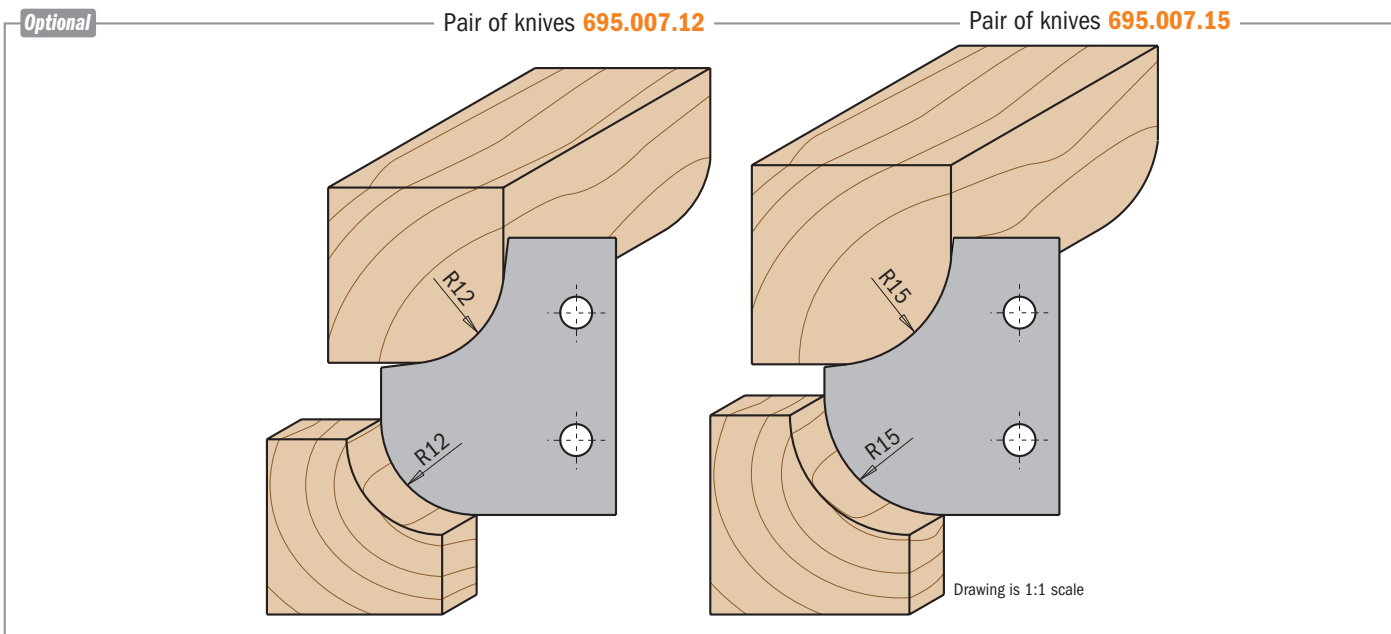
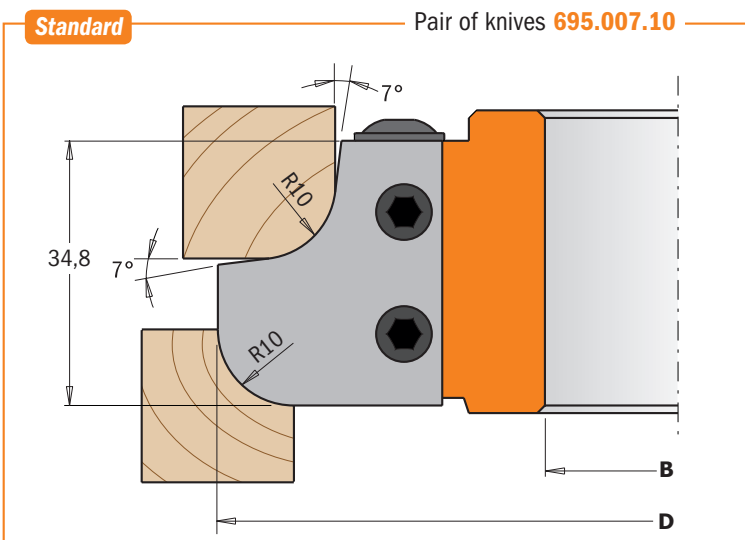

D mm	B mm	Z	RPM		ORDER NO.	Spare parts x2			
121	30	2	6300~10500	1	<b>694.007.30</b>	695.007.10	695.999.31	990.064.00	991.064.00
121	31,75	2	6300~10500	1	<b>694.007.31</b>	695.007.10	695.999.31	990.064.00	991.064.00
121	35	2	6300~10500	1	<b>694.007.35</b>	695.007.10	695.999.31	990.064.00	991.064.00
136	40	2	5600~9300	1	<b>694.007.40</b>	695.007.10	695.999.31	990.064.00	991.064.00
136	50	2	5600~9300	1	<b>694.007.50</b>	695.007.10	695.999.31	990.064.00	991.064.00

**Optional**  
 695.007.12 R=12mm (34,8x29,3x2mm) pair of roundover/cove knives  
 695.007.15 R=15mm (34,8x29,3x2mm) pair of roundover/cove knives



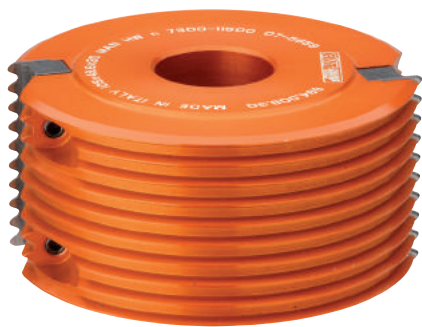

## 694.008



The CMT professional finger joint cutter head makes the strongest side-to-side joints on all wood types and composites. The tightness of the joint and the maximum surface area for glue application ensure that the joint itself is stronger than an unworked piece of wood. Maximum thickness 47mm. For use on spindle moulder machines, double-end tenoner and shaper machines. Suitable for all materials, but ideal on solid wood and panel materials.

### TECHNICAL DETAILS:

- Hard aluminium alloy body with high resistance to tensile and yield stress.
- 2 HWM knives 49,6x11,9x1,5mm [Z2].
- Tools for manual feed (MAN).
- Pins for the automatic positioning of the knives.

Supplied in a solid plastic box.

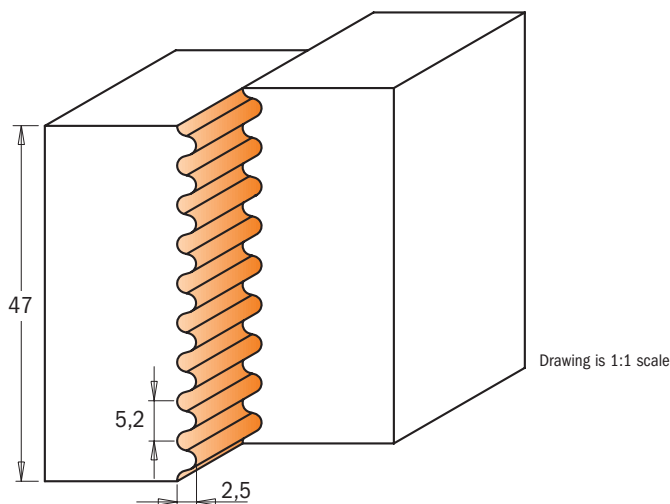
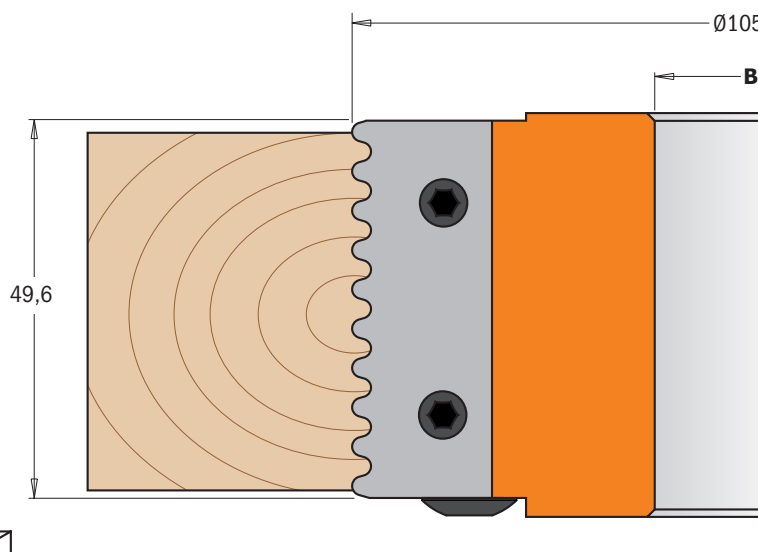

D mm	B mm	Z	RPM		ORDER NO.	Spare parts			
105	30	2	7300~11500	1	<b>694.008.30</b>	x2			
105	31,75	2	7300~11500	1	<b>694.008.31</b>	695.008.01	695.999.49	990.066.00	991.067.00
105	35	2	7300~11500	1	<b>694.008.35</b>	695.008.01	695.999.49	990.066.00	991.067.00
105	40	2	7300~11500	1	<b>694.008.40</b>	695.008.01	695.999.49	990.066.00	991.067.00
105	50	2	7300~11500	1	<b>694.008.50</b>	695.008.01	695.999.49	990.066.00	991.067.00

**Optional**

695.998.2630	Ø50x2,6x30mm guide ring
695.998.2631	Ø50x2,6x31,75mm guide ring
695.998.2635	Ø55x2,6x35mm guide ring
695.998.2640	Ø60x2,6x40mm guide ring
695.998.2650	Ø70x2,6x50mm guide ring

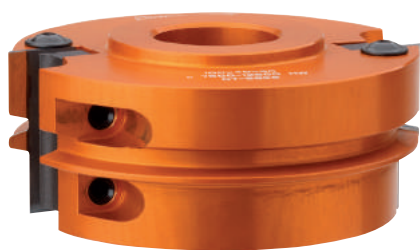

## 694.009

One of the unique characteristics of this particular CMT cutter head is its capacity to craft indestructible glue joints both quickly and accurately. Ideal for shaping panels, doors and furniture pieces of wide proportion. Simply run one side of the panel, turn the panel over, and then run the opposite side. The result? Perfectly harmonized reverse cuts which match up to produce a flawless joint. Excellent for most materials, but ideal on solid wood, coated and uncoated man-made materials.

### TECHNICAL DETAILS:

- Hard aluminium alloy body with high resistance to tensile and yield stress.
- 2 HWM knives 40x18x2mm [Z2].
- Tools for manual feed (MAN).
- Pins for the automatic positioning of the knives.

Supplied in a solid plastic box.

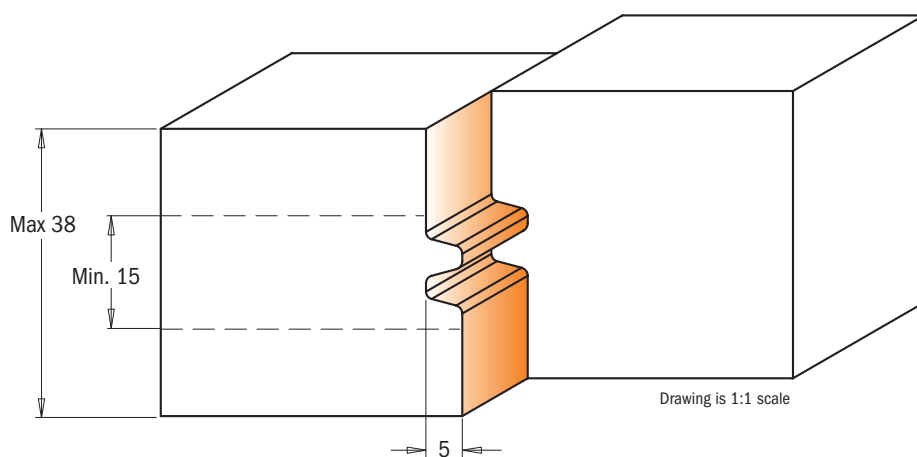
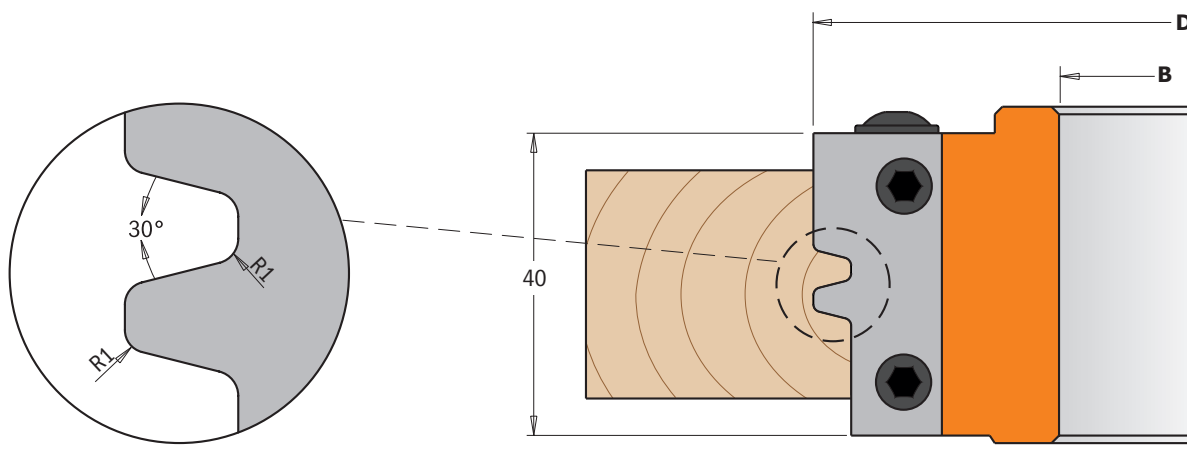

D mm	B mm	Z	RPM		ORDER NO.	Spare parts			
						x2			
100	30	2	7500~12500	1	<b>694.009.30</b>	695.009.01	695.999.38	990.064.00	991.064.00
100	31,75	2	7500~12500	1	<b>694.009.31</b>	695.009.01	695.999.38	990.064.00	991.064.00
100	35	2	7500~12500	1	<b>694.009.35</b>	695.009.01	695.999.38	990.064.00	991.064.00
120	40	2	6400~10500	1	<b>694.009.40</b>	695.009.01	695.999.38	990.064.00	991.064.00
120	50	2	6400~10500	1	<b>694.009.50</b>	695.009.01	695.999.38	990.064.00	991.064.00



## 694.011

CMT's lock miter cutter heads are ideal for milling miter joints in stock with maximum 28mm in thickness. Create boxes, stretcher bars, frames and any assortment of right angle or parallel joint projects. Two easy steps to produce perfect fitting 45° miter joints: first, position your workpiece horizontally, then vertically. Also, create parallel glue joints in two steps: place your workpiece horizontally, internal side facing down, and then turn it facing up. For use on spindle moulder and shaper machines. Perfect on all materials, but ideal on solid wood and panels.

### TECHNICAL DETAILS:



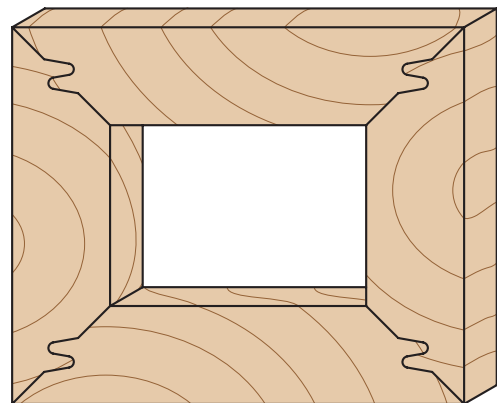
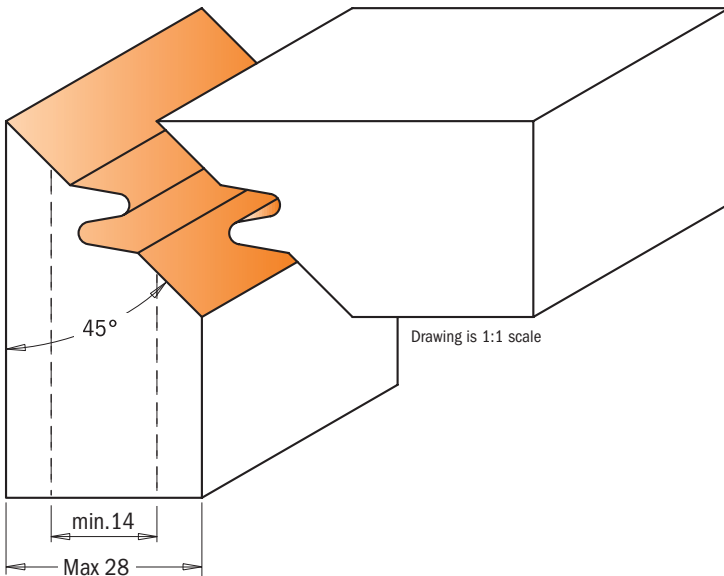
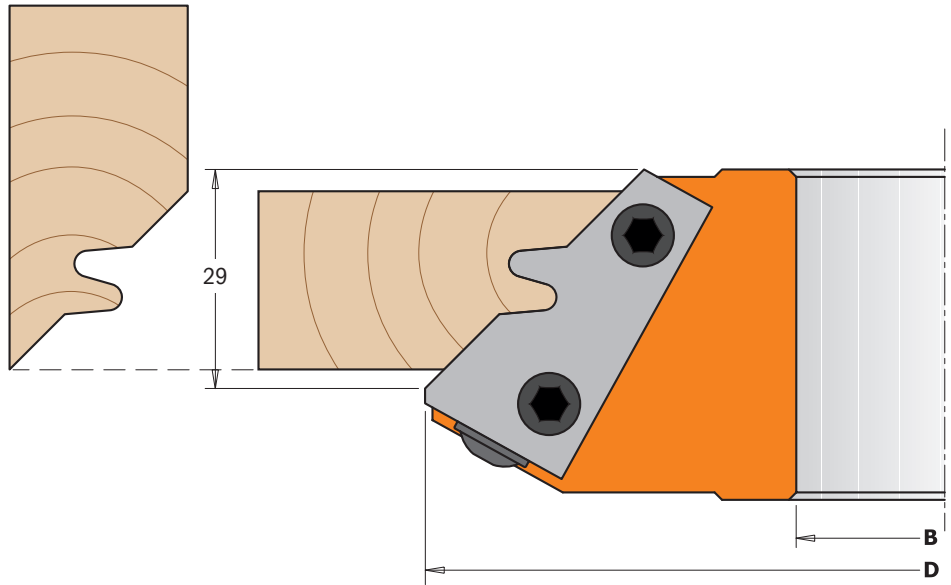

- Hard aluminium alloy body with high resistance to tensile and yield stress.
- 2 HWM knives 43x23x2mm [Z2].
- Tools for manual feed (MAN).
- Pins for the automatic positioning of the knives.

Supplied in a solid plastic box.



D mm	B mm	Z	RPM		ORDER NO.
140	30	2	5500~9500	1	<b>694.011.30</b>
140	31,75	2	5500~9500	1	<b>694.011.31</b>
140	35	2	5500~9500	1	<b>694.011.35</b>
140	40	2	5500~9500	1	<b>694.011.40</b>
150	50	2	5100~8800	1	<b>694.011.50</b>

### Spare parts

 x2			
695.011.01	695.999.42	990.064.00	991.064.00
695.011.01	695.999.42	990.064.00	991.064.00
695.011.01	695.999.42	990.064.00	991.064.00
695.011.01	695.999.42	990.064.00	991.064.00
695.011.01	695.999.42	990.064.00	991.064.00



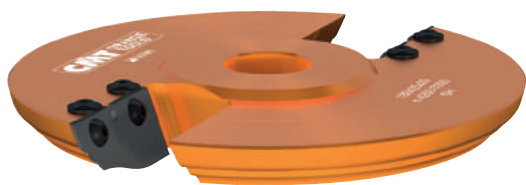

## 694.012

These new CMT cutter heads will allow you to make classic raised panels on furniture, interior and cabinet doors. An exceptional tool that makes up to six different profiles using the optional knives included. A practical and economical solution. We recommend multiple passes for safe and accurate finishing. For use on spindle moulders. Perfect for all materials, but ideal on solid wood and panels.

**Supplied in a solid plastic box.**

### TECHNICAL DETAILS:

- Hard aluminium alloy body with high resistance to tensile and yield stress.
- 2 HWM Knives type (A) 50x25x2mm [Z2].
- Tools for manual feed (MAN)
- Pins for the automatic positioning of the knives.

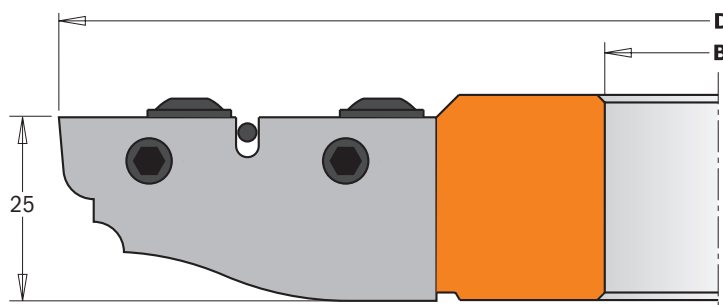

### Standard

Pair of knives **695.012A**

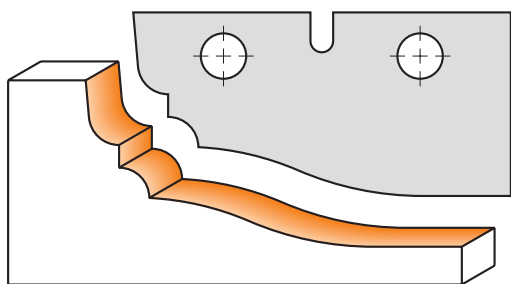

Drawing is 1:1 scale

### Optional

Pair of knives **695.012B**

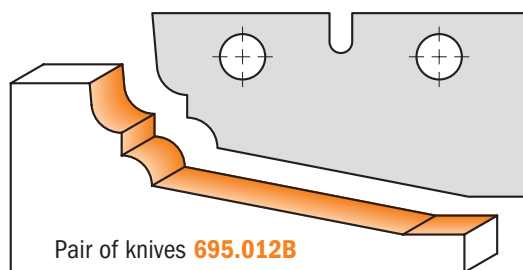

Pair of knives **695.012C**

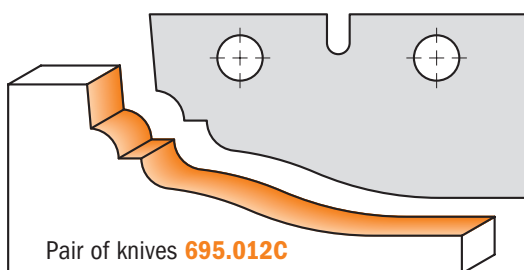

Pair of knives **695.012D**

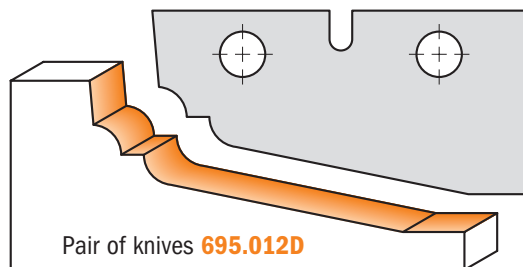

Pair of knives **695.012E**

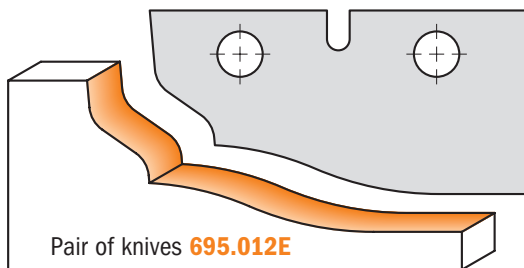

Pair of knives **695.012G**

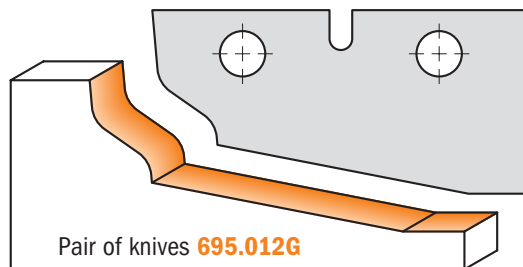

D mm	I mm	B mm	Z	RPM		ORDER NO.	Spare parts x2		
180	25	30	2	4200~7000	1	<b>694.012.30</b>	695.012A	990.107.00	991.067.00
180	25	35	2	4200~7000	1	<b>694.012.35</b>	695.012A	990.107.00	991.067.00
180	25	40	2	4200~7000	1	<b>694.012.40</b>	695.012A	990.107.00	991.067.00
180	25	50	2	4200~7000	1	<b>694.012.50</b>	695.012A	990.107.00	991.067.00
<b>Optional</b>	<b>695.012B</b>	50x25x2mm pair of knives type (B)			<b>695.012E</b>	50x25x2mm pair of knives type (E)			
	<b>695.012C</b>	50x25x2mm pair of knives type (C)			<b>695.012G</b>	50x25x2mm pair of knives type (G)			
	<b>695.012D</b>	50x25x2mm pair of knives type (D)							



## 694.013



We offer a traditional approach to panel construction with these CMT raised panel cutter heads. Make classic raised panels on furniture, interior and cabinet doors on solid wood and wooden boards, and achieve three different profiles by adjusting the cutting depth. We recommend multiple passes for safe and accurate finishing. For use on spindle moulders. Perfect for all materials, but ideal on solid wood and panels.



### TECHNICAL DETAILS:

- Hard aluminium alloy body with high resistance to tensile and yield stress.
- 2 HWM Knives type (A) 19,8x11,9x1,5mm [Z2].
- 2 HWM Knives type (B) 60x11,9x1,5mm [Z2].
- Tools for manual feed (MAN).
- Pins for the automatic positioning of the knives.

Supplied in a solid plastic box.

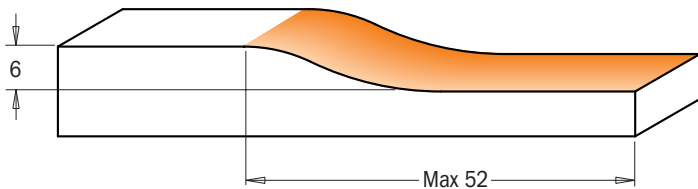
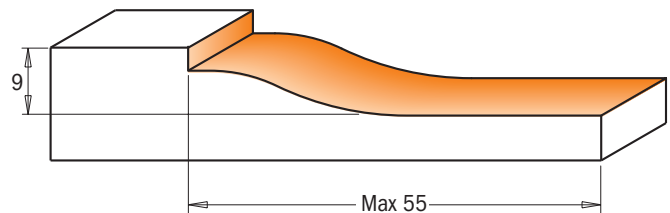
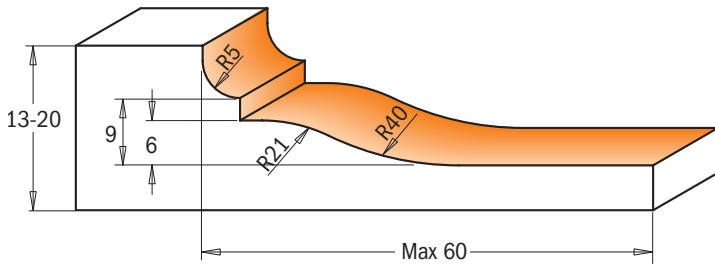
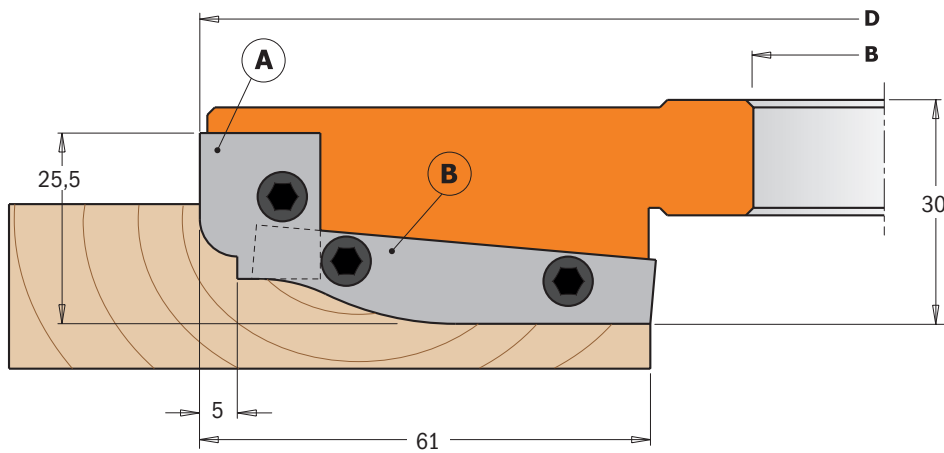

Drawing is 1:1 scale

D mm	B mm	Z	RPM		ORDER NO.	Spare parts				
						x2	16x11x9,5mm	x2	53x11x9,5mm	
183	30	2+2	4100~7000	1	<b>694.013.30</b>	695.013.A1	695.999.16	695.013.A2	695.999.53	990.066.00
183	31,75	2+2	4100~7000	1	<b>694.013.31</b>	695.013.A1	695.999.16	695.013.A2	695.999.53	990.066.00
183	35	2+2	4100~7000	1	<b>694.013.35</b>	695.013.A1	695.999.16	695.013.A2	695.999.53	990.066.00
200	40	2+2	3800~6400	1	<b>694.013.40</b>	695.013.A1	695.999.16	695.013.A2	695.999.53	990.066.00
200	50	2+2	3800~6400	1	<b>694.013.50</b>	695.013.A1	695.999.16	695.013.A2	695.999.53	990.066.00

Spare parts 991.083.00 3x90x135mm hex key



## 694.015

These versatile sets were designed to make furniture and doors on soft and hardwood. It allows the insertion of five different knives to produce the most popular and classical profiles. The adjustable cutter, included in the set, can also be used individually to carry out grooves between 8mm 15mm thick. For use on spindle moulders. Perfect on solid wood and panels maximum 48mm (1-7/8") in thickness.

### TECHNICAL DETAILS:

- Hard aluminium alloy body with high resistance to tensile and yield stress for cutter heads (1 & 2).
- Super-strength steel body for cutter head (3).
- 2 HWM knives type (A1) 25x29,8x2mm [Z2].
- 2 HWM knives type (A2) 25x29,8x2mm [Z2].
- 4 HWM knives 7,65x12x1,5mm [Z4].
- 4 HWM knives 14x14x2m for heads type (1 & 2).
- 12 spacer rings from 0,1 to 3mm for heads type (1 & 2).
- 12 spacer rings from 0,1 to 2mm for heads type (3).
- Tools for manual feed (MAN).
- Pins for the automatic positioning of the knives.

Supplied in a solid plastic box.

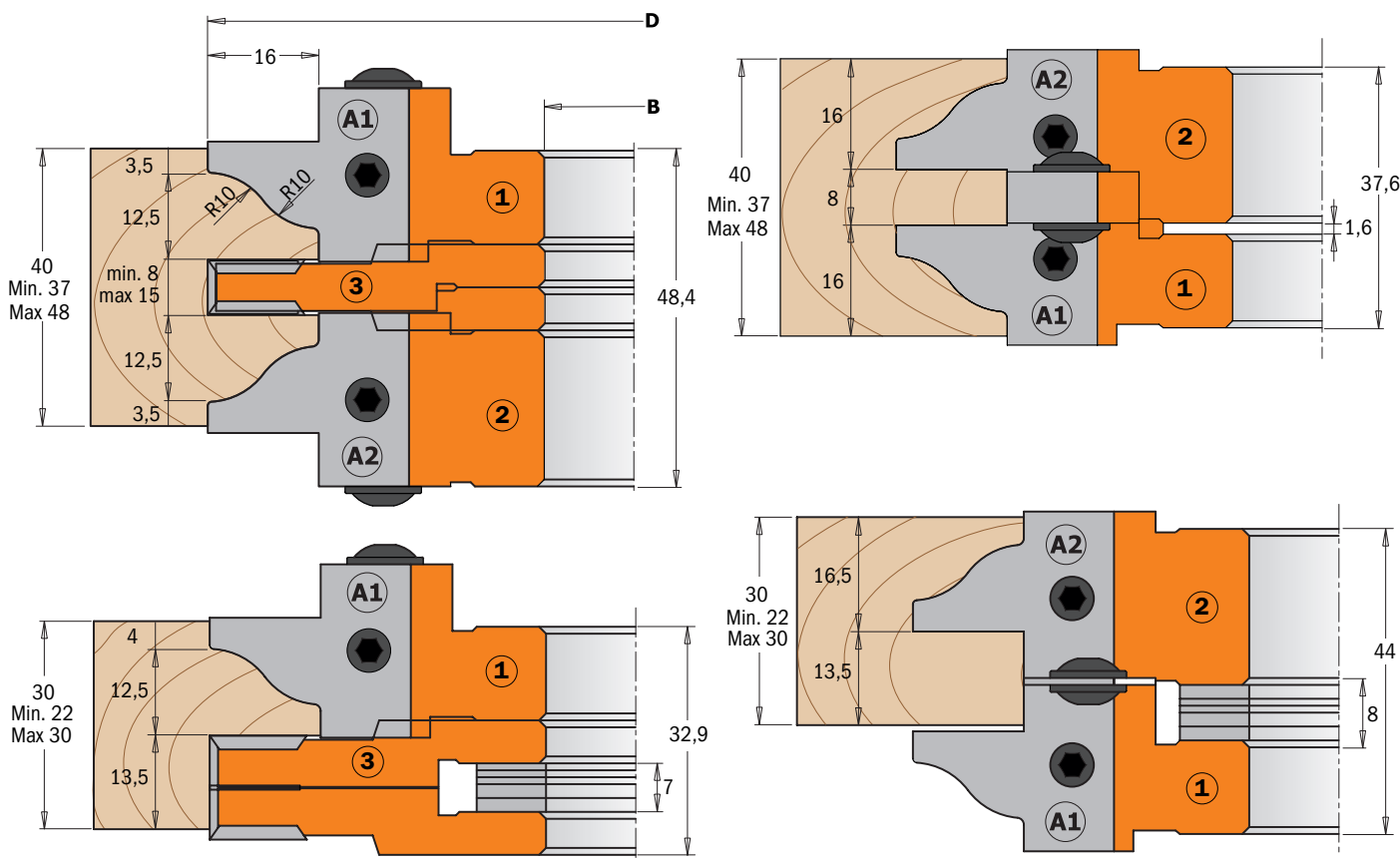

D mm	B mm	Z+V	RPM		ORDER NO.
132	30	2+4	5700~9500	1	<b>694.015.30</b>
132	31,75	2+4	5700~9500	1	<b>694.015.31</b>
132	35	2+4	5700~9500	1	<b>694.015.35</b>
147	40	2+4	5100~8500	1	<b>694.015.40</b>
147	50	2+4	5100~8500	1	<b>694.015.50</b>

### Spare parts

695.998.01	695.998.21	695.998.30
695.998.02	695.998.22	695.998.31
695.998.03	695.998.23	695.998.35
695.998.04	695.998.24N	695.998.40
695.998.05	695.998.25N	

### Spare parts

#### Head type (1)

- 695.015.A1 25x29,8x2mm HWM pair of knives (A1)
- 695.015.B1 25x29,8x2mm HWM pair of knives (B1)
- 695.015.C1 25x29,8x2mm HWM pair of knives (C1)
- 695.015.D1 25x29,8x2mm HWM pair of knives (D1)
- 695.015.E1 25x29,8x2mm HWM pair of knives (E1)
- 695.999.23 23x11x9,5mm wedge for knives
- 990.066.00 M6x16mm screw
- 991.067.00 3mm hex key

#### Head type (2)

- 695.015.A2 25x29,8x2mm HWM pair of knives (A2)
- 695.015.B2 25x29,8x2mm HWM pair of knives (B2)
- 695.015.C2 25x29,8x2mm HWM pair of knives (C2)
- 695.015.D2 25x29,8x2mm HWM pair of knives (D2)
- 695.015.E2 25x29,8x2mm HWM pair of knives (E2)
- 695.999.24 23x11x9,5mm wedge for knives
- 990.066.00 M6x16mm screws
- 991.067.00 3mm hex key

#### Head type (3)

- 790.076.00 7,65x12x1,5mm HWM knives
- 695.999.07 6,8x11x9,5mm wedge for knives
- 990.063.00 M5x18mm screw
- 991.072.00 T20 hex key
- 790.140.00 14x14x2mm HWM Knives
- 990.080.00 M5x6,5mm screw
- 991.073.00 T25 hex key

790.076.00 and 790.140.00 are supplied in 10-piece pack or multiple



**Standard**

Pair of knives **695.015.A1** - Pair of knives **695.015.A2**

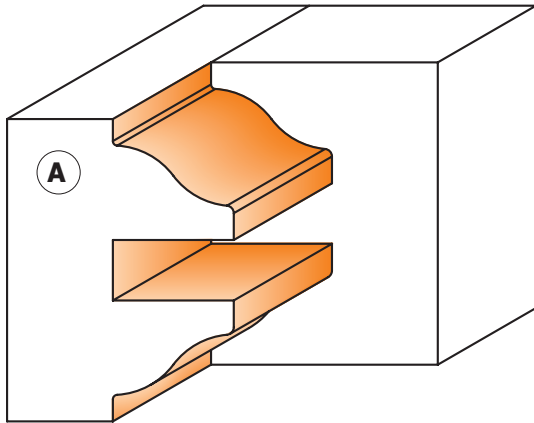

Drawing is 1:1 scale

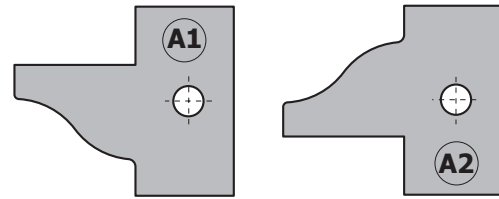

**Optional**

Pair of knives **695.015.B1**  
Pair of knives **695.015.B2**

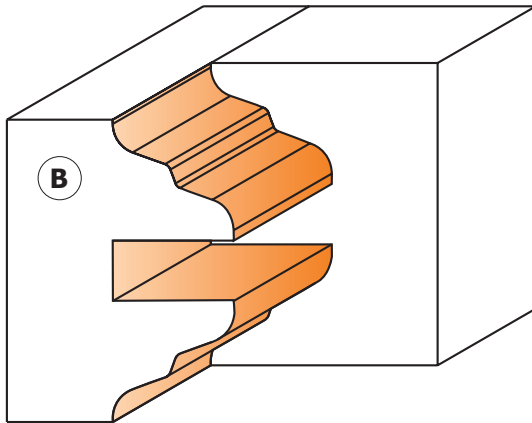
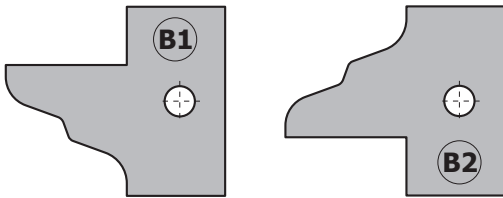

Pair of knives **695.015.C1**  
Pair of knives **695.015.C2**

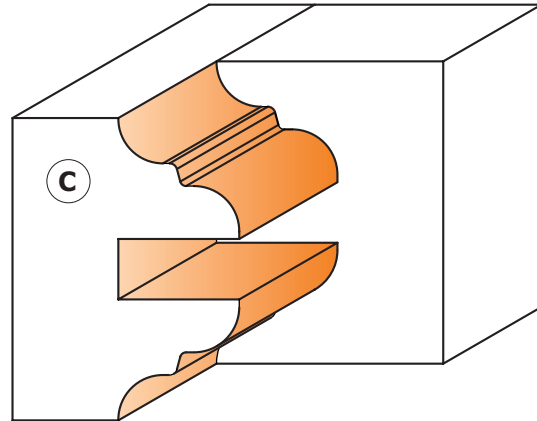
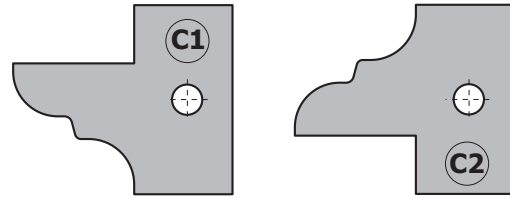

Pair of knives **695.015.D1**  
Pair of knives **695.015.D2**

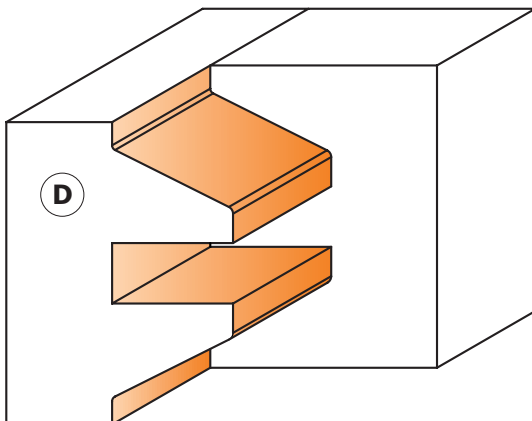
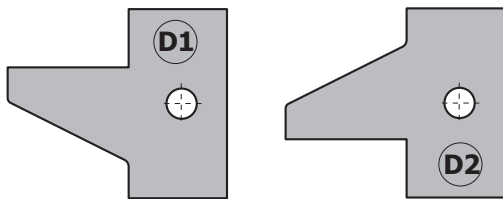

Pair of knives **695.015.E1**  
Pair of knives **695.015.E2**

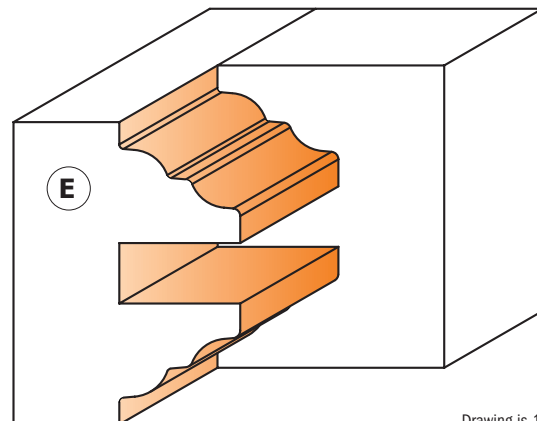
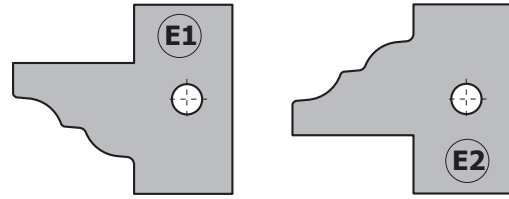

Drawing is 1:1 scale

# 1 Piece Rail & Stile Cutter Heads

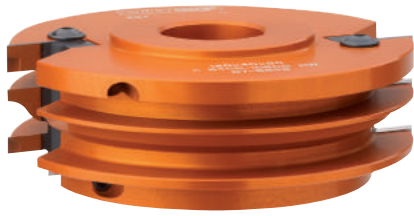

## 694.014

These are unique products made by combining two cutter heads, ideal for making furniture doors and drawers. By adjusting the height of the of the cutter head, you can cut two perfectly fitted profiles without wasting time or effort on the fence or replacing the tool. Improve your efficiency and save money only having to purchase one single cutter head!!! For use on spindle moulers. Perfect on hardwood and panels between 22mm-25mm in thickness.

### TECHNICAL DETAILS:

- Hard aluminium alloy body with high resistance to tensile and yield stress.
- 2 HWM Knives type (A) 40x24,5x2mm [Z2].
- Tools for manual feed (MAN).
- Pins for the automatic positioning of the knives.

Supplied in a solid plastic box.



### Standard

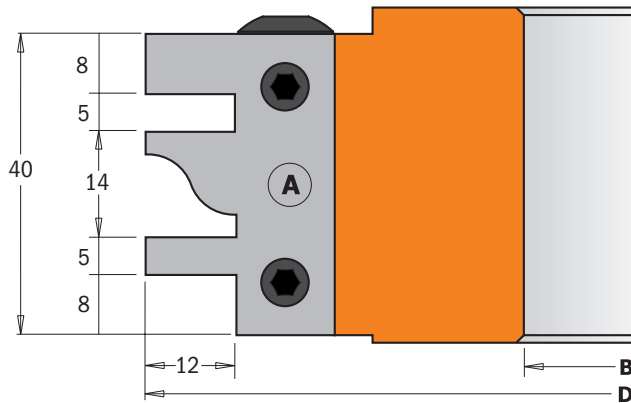

### Pair of knives 695.014A

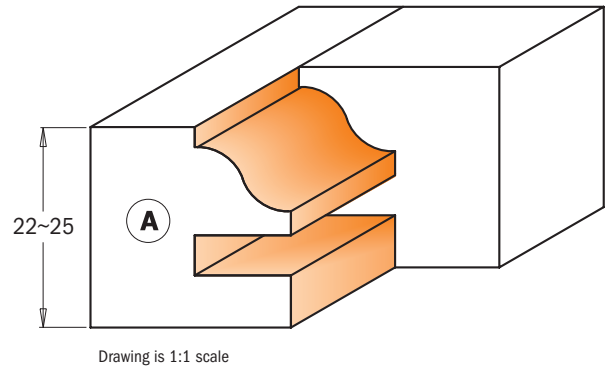

### Optional

### Pair of knives 695.014B

### Pair of knives 695.014C

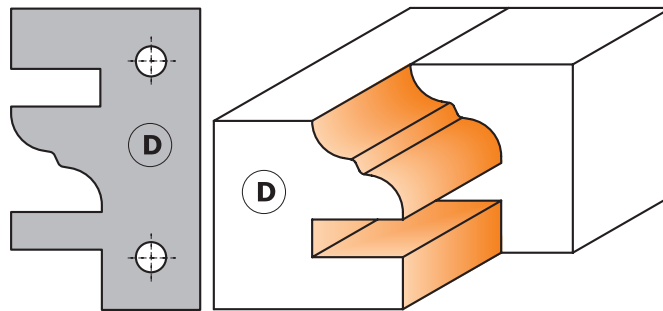
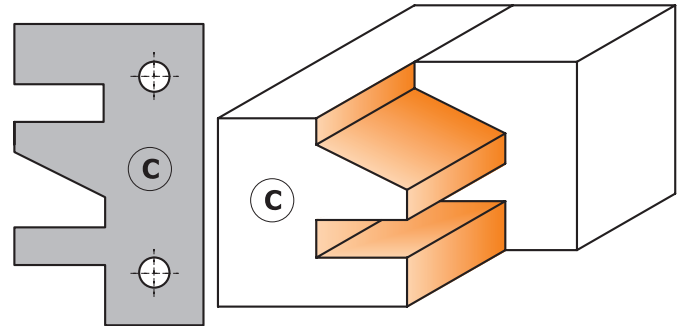
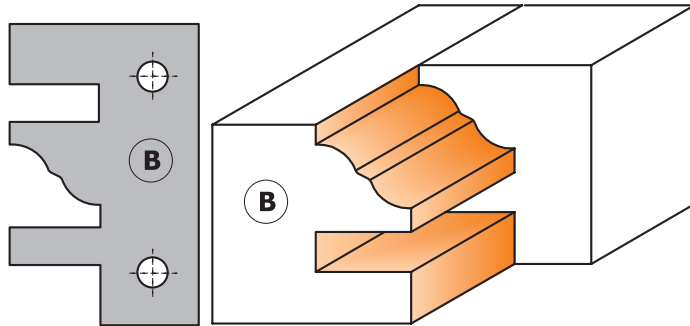

### Pair of knives 695.014D

Drawing is 1:1 scale

D mm	B mm	Z	RPM		ORDER NO.	Spare parts			
120	30	2	6400~10500	1	<b>694.014.30</b>	x2			
120	31,75	2	6400~10500	1	<b>694.014.31</b>	695.014A	695.999.39	990.066.00	991.067.00
120	35	2	6400~10500	1	<b>694.014.35</b>	695.014A	695.999.39	990.066.00	991.067.00
120	40	2	6400~10500	1	<b>694.014.40</b>	695.014A	695.999.39	990.066.00	991.067.00
130	50	2	5900~9700	1	<b>694.014.50</b>	695.014A	695.999.39	990.066.00	991.067.00

Optional	Part No.	Description
	695.014B	40x24,5x2mm pair of knives type (B)
	695.014C	40x24,5x2mm pair of knives type (C)
	695.014D	40x24,5x2mm pair of knives type (D)

# Cutter Heads without Limiters



## 692

CMT cutter heads guarantee excellent performance for all your projects. For use on all types of moulder and spindle moulder machines.

**TECHNICAL DETAILS:**

- Hard aluminium or steel alloy cutter head without limiters, highly resistant to tensile and yield stress.
- Pair of universal straight knives included.
- Tools for mechanical feed (MEC).
- Pins for the automatic positioning of the knives.
- Possibility to use knives with a height of 40mm or 50mm (order no. 690).

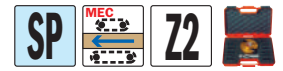

Supplied in a solid plastic box to contain up to 12 couples of knives.

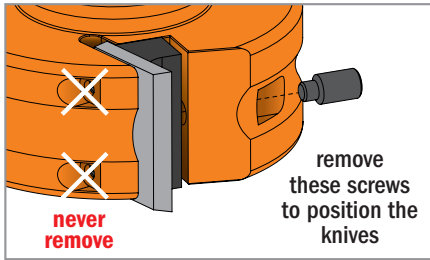

remove these screws to position the knives

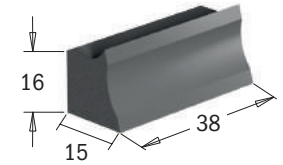
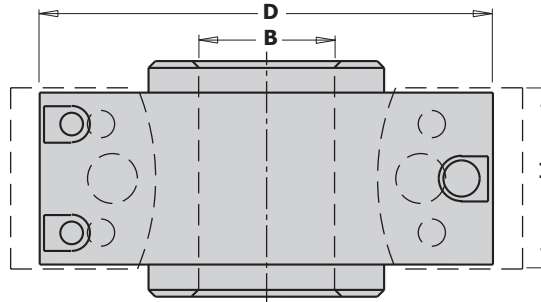

D mm	I mm	B mm	RPM		ORDER NO. Steel body	ORDER NO. Aluminium body
78	40	19,05	7000~9000	1		<b>692.078.19*</b>
78	40	30	7000~9000	1		<b>692.078.30*</b>
100	40-50	25,4	5500~8400	1		<b>692.100.26</b>
100	40-50	30	5500~8400	1	<b>692.101.30</b>	<b>692.100.30</b>
100	40-50	31,75	5500~8400	1		<b>692.100.31</b>
100	40-50	35	5500~8400	1	<b>692.101.35</b>	<b>692.100.35</b>
120	40-50	50	4800~7400	1	<b>692.121.50</b>	<b>692.120.50</b>

**Spare parts**

692.999.01	990.064.00	991.064.00
692.999.01	990.064.00	991.064.00
692.999.01	990.064.00	991.064.00
692.999.01	990.064.00	991.064.00
692.999.01	990.064.00	991.064.00
692.999.01	990.064.00	991.064.00
692.999.01	990.064.00	991.064.00

\*For safety reasons we recommend the use of knives with a 40mm height only.

# Cutter Heads with Limiters



## 693

CMT cutter heads guarantee excellent performance for all your projects. For use on all types of moulder and spindle moulder machines.

**TECHNICAL DETAILS:**

- Hard aluminium or steel alloy cutter head with limiters, highly resistant to tensile and yield stress.
- Pair of universal straight knives and limiters included.
- Tools for manual feed (MAN).
- Pins for the automatic positioning of the knives.
- Possibility to use knives with a height of 40mm or 50mm (order no. 690) and limiters (order no. 691).



Made in compliance with EU Directive EN 847-1.

Supplied in a solid plastic box to contain up to 12 couples of knives.

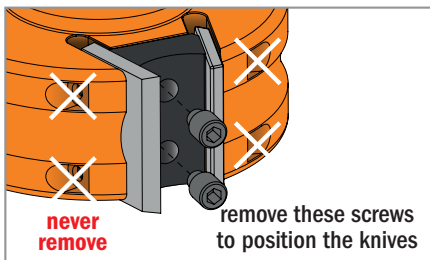

remove these screws to position the knives

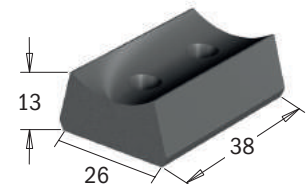
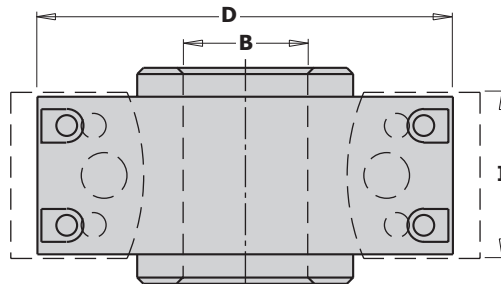

D mm	I mm	B mm	RPM		ORDER NO. Steel body	ORDER NO. Aluminium body
78	40	30	7000~9000	1	<b>693.078.30</b>	
100	40-50	30	5500~8400	1	<b>693.101.30</b>	<b>693.100.30</b>
100	40-50	31,75	5500~8400	1		<b>693.100.31</b>
100	40-50	35	5500~8400	1	<b>693.101.35</b>	<b>693.100.35</b>
120	40-50	50	4800~7400	1	<b>693.121.50</b>	<b>693.120.50</b>

**Spare parts**

693.999.01	990.065.00	991.064.00
693.999.01	990.065.00	991.064.00
693.999.01	990.065.00	991.064.00
693.999.01	990.065.00	991.064.00
693.999.01	990.065.00	991.064.00



# 13 Piece Multiprofile Cutter Head Sets without Limiters



## 692

These sets are ideal for making joints and frames and include 3 essential profiles specifically for crafting doors. An invaluable asset for any professional woodworker. The cutter heads included allow the insertion of knives at a height of either 40mm or 50mm. Both cutter head and knives are stored in solid plastic cases to prevent damage.

**These sets include:**

- 1 cutter head in hard aluminium alloy with pins for the automatic positioning of the knives.
- 13 pairs of knives with a cutting height of 40mm.

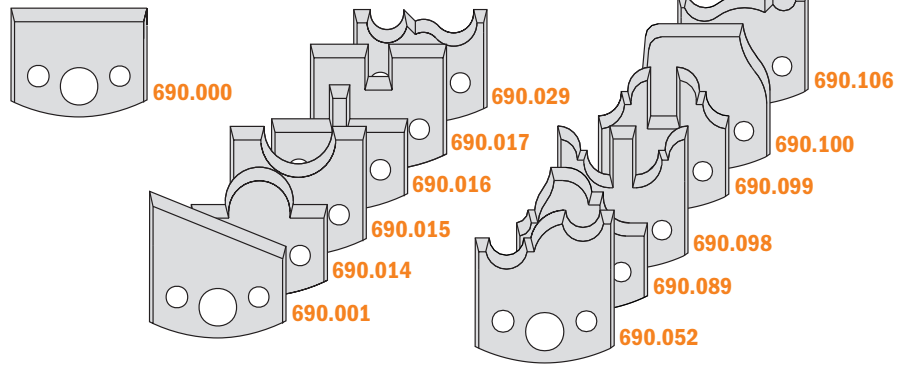
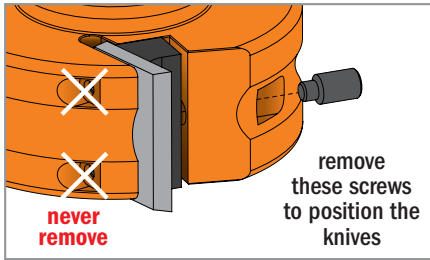

D mm	I mm	B mm	RPM		ORDER NO.
78	40	19,05	7000~9000	1	<b>692.013.09</b>
78	40	30	7000~9000	1	<b>692.013.01</b>
100	40	25,4	5500~8400	1	<b>692.013.10</b>
100	40	30	5500~8400	1	<b>692.013.02</b>
100	40	31,75	5500~8400	1	<b>692.013.11</b>
100	40	35	5500~8400	1	<b>692.013.03</b>
120	40	50	4800~7400	1	<b>692.013.04</b>

Spare parts

692.999.01	990.064.00	991.064.00
692.999.01	990.064.00	991.064.00
692.999.01	990.064.00	991.064.00
692.999.01	990.064.00	991.064.00
692.999.01	990.064.00	991.064.00
692.999.01	990.064.00	991.064.00
692.999.01	990.064.00	991.064.00



## 692

These sets include 13 profile knives for making joints, frames, multiple profiles, moldings and chamfers. Ideal for the professional woodworker. The cutter head included allows the insertion of knives at a height of either 40mm or 50mm. Both cutter head and knives are stored in solid plastic cases to prevent damage.

**These sets include:**

- 1 cutter head in hard aluminium alloy with pins for the automatic positioning of the knives.
- 13 pairs of knives with a cutting height of 40mm.

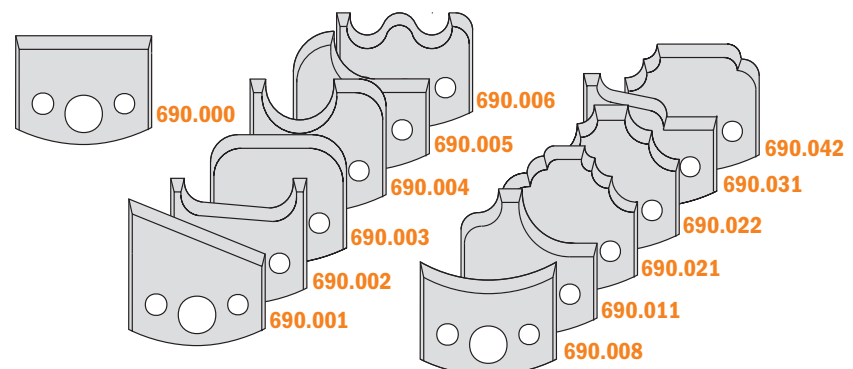
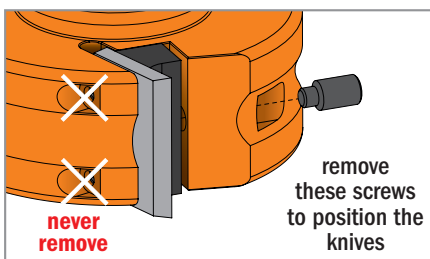

D mm	I mm	B mm	RPM		ORDER NO.
78	40	19,05	7000~9000	1	<b>692.013.12</b>
78	40	30	7000~9000	1	<b>692.013.05</b>
100	40	25,4	5500~8400	1	<b>692.013.13</b>
100	40	30	5500~8400	1	<b>692.013.06</b>
100	40	31,75	5500~8400	1	<b>692.013.14</b>
100	40	35	5500~8400	1	<b>692.013.07</b>
120	40	50	4800~7400	1	<b>692.013.08</b>

Spare parts

692.999.01	990.064.00	991.064.00
692.999.01	990.064.00	991.064.00
692.999.01	990.064.00	991.064.00
692.999.01	990.064.00	991.064.00
692.999.01	990.064.00	991.064.00
692.999.01	990.064.00	991.064.00
692.999.01	990.064.00	991.064.00

## 7 Piece Multiprofile Cutter Head Sets with Limiters



### 693

The professional woodworker now has the chance to make kitchen doors with a horizontal profile and male-and-female joints with two pairs of cutters. In fact, along with 7 profiled knives these sets also contain a specially designed cutter head that allows the insertion of knives with a height of either 40mm or 50mm, and safety limiters produced in compliance with the European Regulation EN 847-1. Both cutter head and knives are stored in solid plastic cases to prevent damage.

**These sets include:**

- 1 cutter head in hard aluminium alloy allowing the insertion of straight knives, limiters and pins for the automatic positioning of the knives.
- 7 pairs of knives with 40mm of cutting.
- 7 pairs of relative limiters.

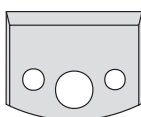

690.000  
691.000

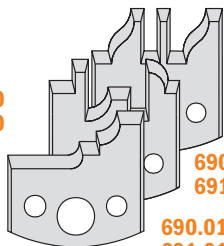

690.097  
691.097  
690.096  
691.096  
690.019  
691.019

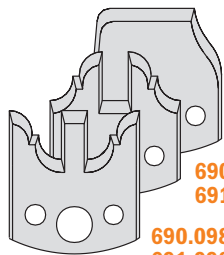

690.100  
691.100  
690.099  
691.099  
690.098  
691.098

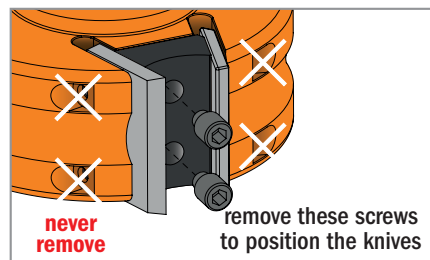

D mm	I mm	B mm	RPM		ORDER NO.
100	40	30	5500~8400	1	<b>693.013.01</b>
100	40	35	5500~8400	1	<b>693.013.02</b>
120	40	50	4800~7400	1	<b>693.013.03</b>

**Spare parts**

693.999.01	990.065.00	991.064.00
693.999.01	990.065.00	991.064.00
693.999.01	990.065.00	991.064.00

## 7 Piece Multiprofile Cutter Head Sets with Limiters



### 693

This set contains 7 profiles knives and a cutter head for making joints, frames and chamfers. The cutter heads allow the insertion of knives at a height of either 40mm or 50mm. Safety limiters are produced in compliance with EU Directive EN 847-1. both cutter head and knives are stored in solid plastic cases to prevent damage.

**These sets include:**

- 1 cutter head in hard aluminium alloy allowing the insertion of straight knives, limiters and pins for the automatic positioning of the knives.
- 7 pairs of knives with 40mm of cutting.
- 7 pairs of relative limiters.

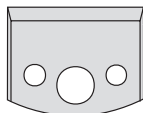

690.000  
691.000

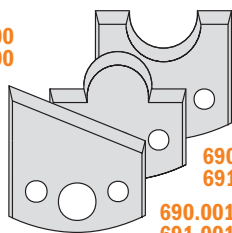

690.015  
691.015  
690.014  
691.014  
690.001  
691.001

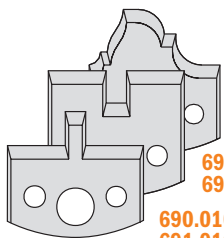

690.089  
691.089  
690.017  
691.017  
690.016  
691.016

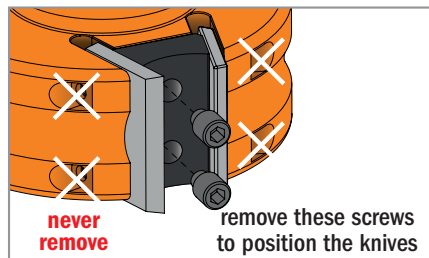

D mm	I mm	B mm	RPM		ORDER NO.
100	40	30	5500~8400	1	<b>693.013.04</b>
100	40	35	5500~8400	1	<b>693.013.05</b>
120	40	50	4800~7400	1	<b>693.013.06</b>

**Spare parts**

693.999.01	990.065.00	991.064.00
693.999.01	990.065.00	991.064.00
693.999.01	990.065.00	991.064.00



# Profile Knives and Limiters

Cutting Length=40mm

Thickness=4mm

Pack Qty. 10

SP

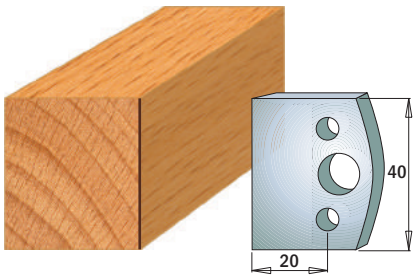

Pair of knives **690.000**  
Pair of limiters **691.000**

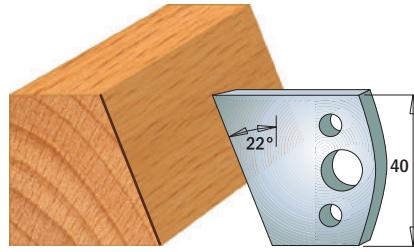

Pair of knives **690.001**  
Pair of limiters **691.001**

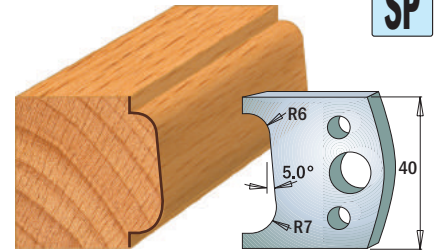

Pair of knives **690.002**  
Pair of limiters **691.002**

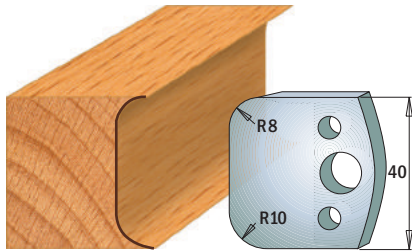

Pair of knives **690.003**  
Pair of limiters **691.003**

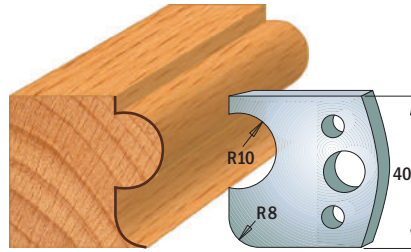

Pair of knives **690.004**  
Pair of limiters **691.004**

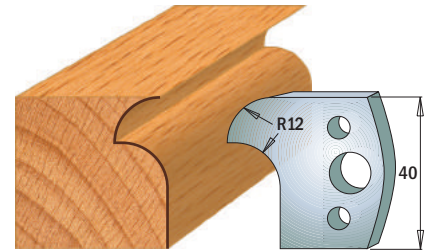

Pair of knives **690.005**  
Pair of limiters **691.005**

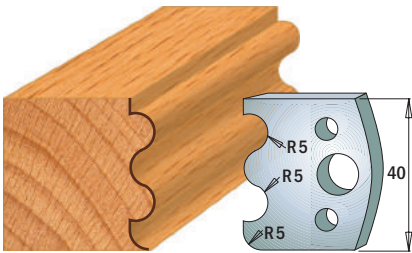

Pair of knives **690.006**  
Pair of limiters **691.006**

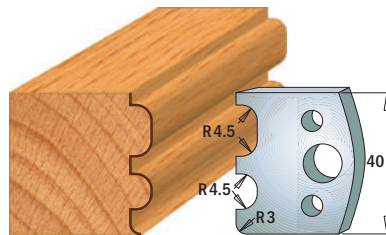

Pair of knives **690.007**  
Pair of limiters **691.007**

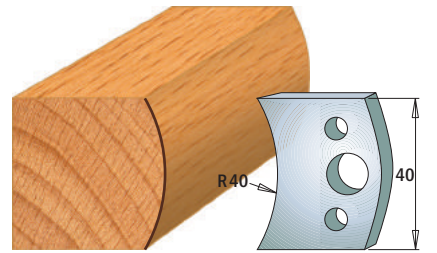

Pair of knives **690.008**  
Pair of limiters **691.008**

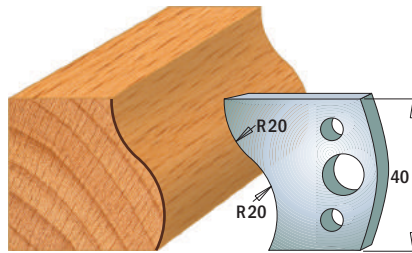

Pair of knives **690.009**  
Pair of limiters **691.009**

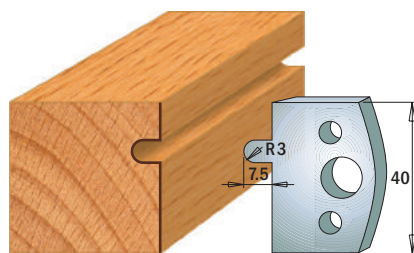

Pair of knives **690.010**  
Pair of limiters **691.010**

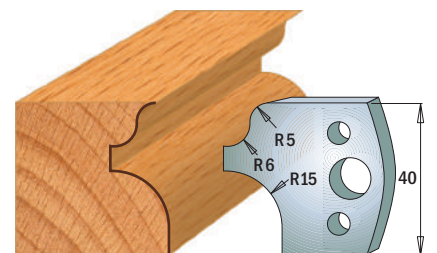

Pair of knives **690.011**  
Pair of limiters **691.011**

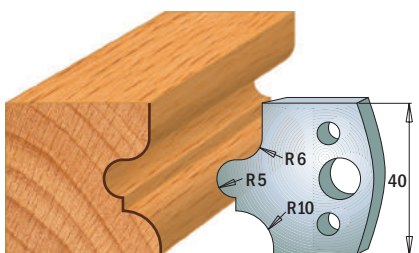

Pair of knives **690.012**  
Pair of limiters **691.012**

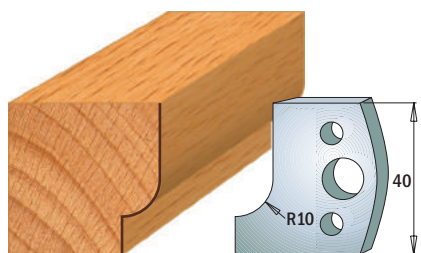

Pair of knives **690.013**  
Pair of limiters **691.013**

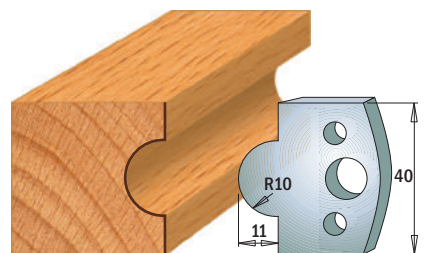

Pair of knives **690.014**  
Pair of limiters **691.014**

**NOTE:** all knives & limiters available only in pairs

Drawings are 1:2 scale

Dimensions in mm.



# Profile Knives and Limiters

Cutting Length=40mm Thickness=4mm

Pack Qty. 10



SP

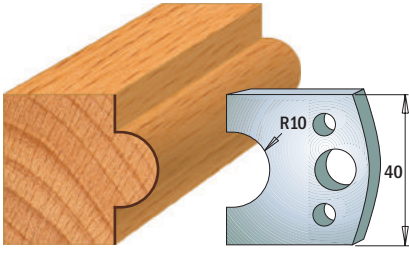

Pair of knives **690.015**  
Pair of limiters **691.015**

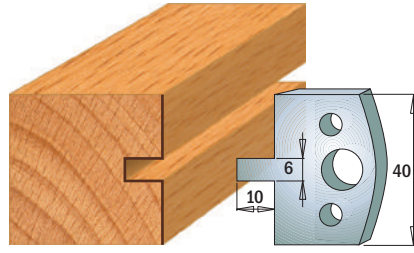

Pair of knives **690.016**  
Pair of limiters **691.016**

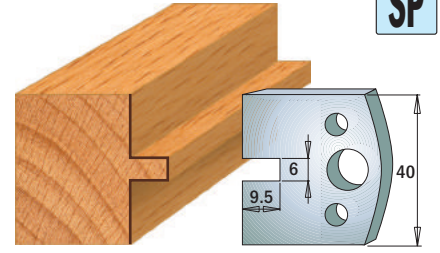

Pair of knives **690.017**  
Pair of limiters **691.017**

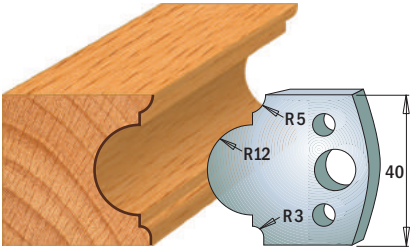

Pair of knives **690.018**  
Pair of limiters **691.018**

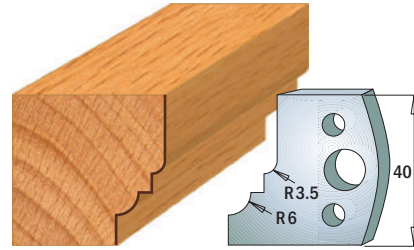

Pair of knives **690.019**  
Pair of limiters **691.019**

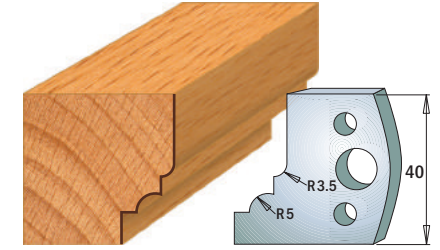

Pair of knives **690.020**  
Pair of limiters **691.020**

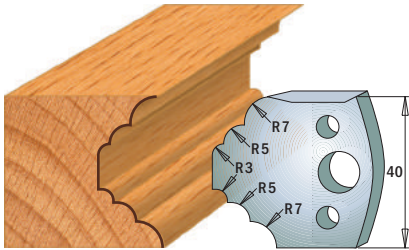

Pair of knives **690.021**  
Pair of limiters **691.021**

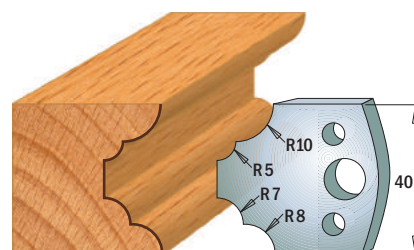

Pair of knives **690.022**  
Pair of limiters **691.022**

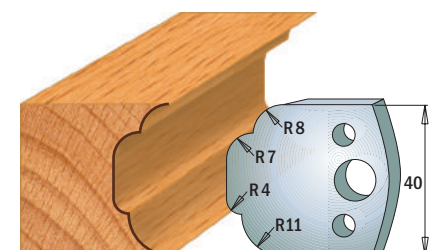

Pair of knives **690.023**  
Pair of limiters **691.023**

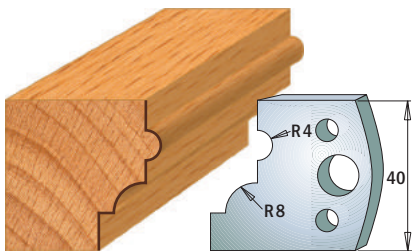

Pair of knives **690.024**  
Pair of limiters **691.024**

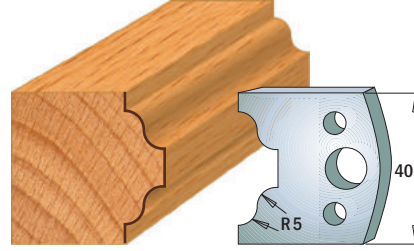

Pair of knives **690.025**  
Pair of limiters **691.025**

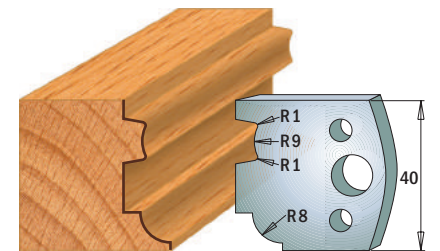

Pair of knives **690.026**  
Pair of limiters **691.026**

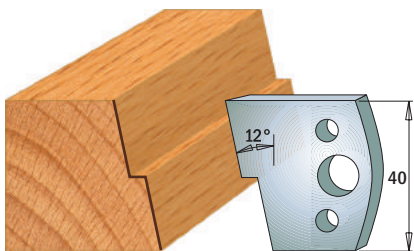

Pair of knives **690.027**  
Pair of limiters **691.027**

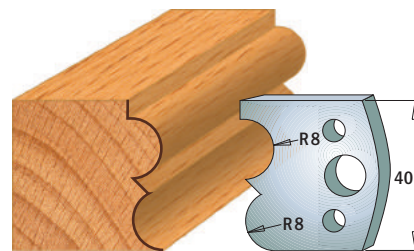

Pair of knives **690.028**  
Pair of limiters **691.028**

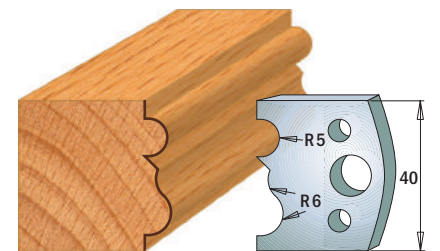

Pair of knives **690.029**  
Pair of limiters **691.029**

**NOTE:** all knives & limiters available only in pairs

Drawings are 1:2 scale

Dimensions in mm.



# Profile Knives and Limiters

Cutting Length=40mm

Thickness=4mm

Pack Qty. 10



SP

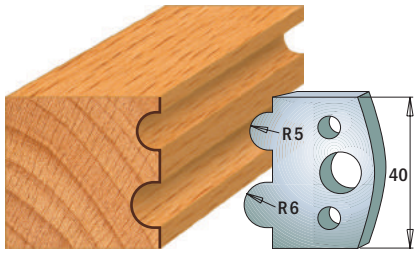

Pair of knives **690.030**  
Pair of limiters **691.030**

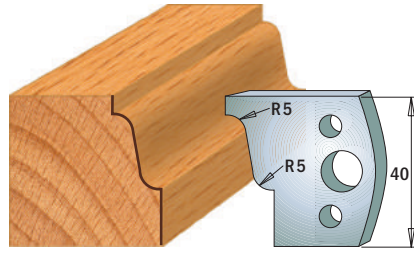

Pair of knives **690.031**  
Pair of limiters **691.031**

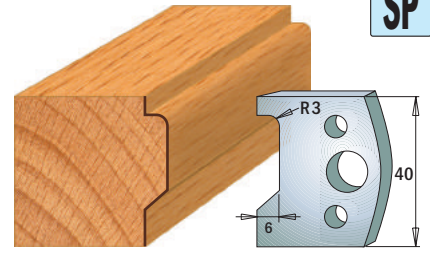

Pair of knives **690.032**  
Pair of limiters **691.032**

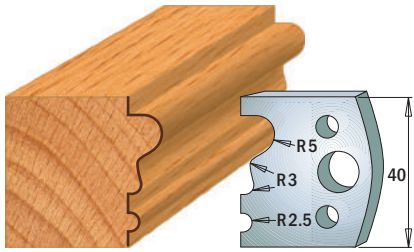

Pair of knives **690.033**  
Pair of limiters **691.033**

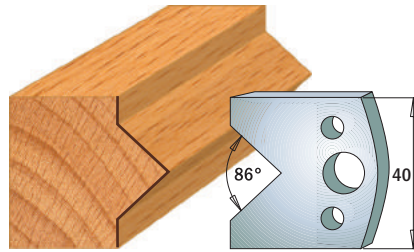

Pair of knives **690.034**  
Pair of limiters **691.034**

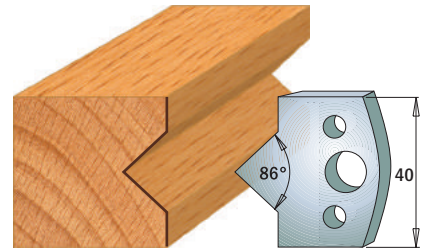

Pair of knives **690.035**  
Pair of limiters **691.035**

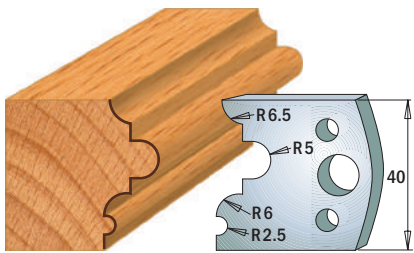

Pair of knives **690.036**  
Pair of limiters **691.036**

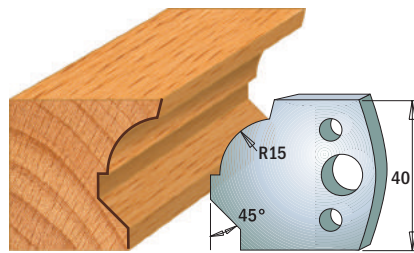

Pair of knives **690.037**  
Pair of limiters **691.037**

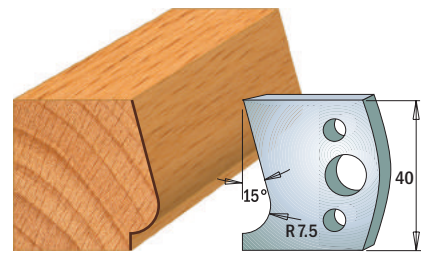

Pair of knives **690.038**  
Pair of limiters **691.038**

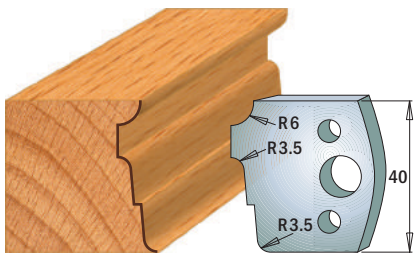

Pair of knives **690.039**  
Pair of limiters **691.039**

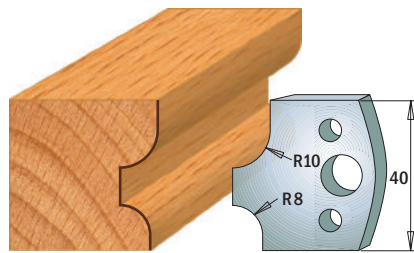

Pair of knives **690.040**  
Pair of limiters **691.040**

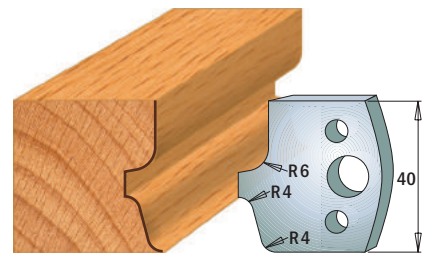

Pair of knives **690.041**  
Pair of limiters **691.041**

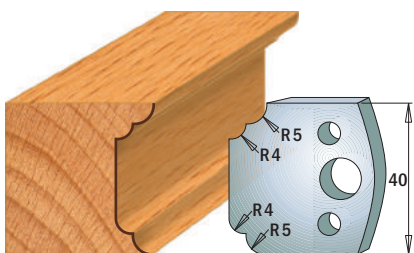

Pair of knives **690.042**  
Pair of limiters **691.042**

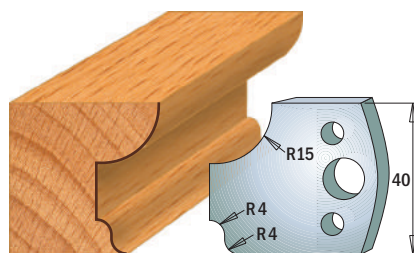

Pair of knives **690.043**  
Pair of limiters **691.043**

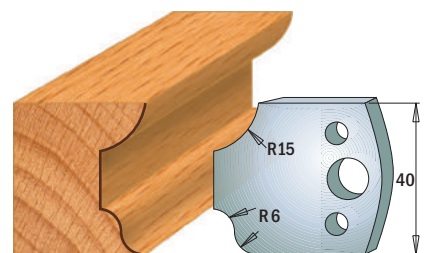

Pair of knives **690.044**  
Pair of limiters **691.044**

**NOTE:** all knives & limiters available only in pairs

Drawings are 1:2 scale

Dimensions in mm.



# Profile Knives and Limiters

Cutting Length=40mm Thickness=4mm

Pack Qty. 10



SP

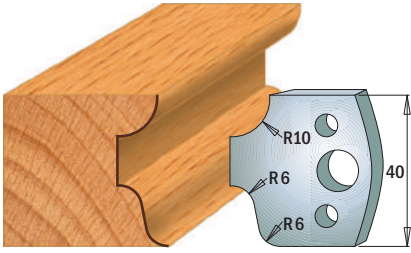

Pair of knives **690.045**  
Pair of limiters **691.045**

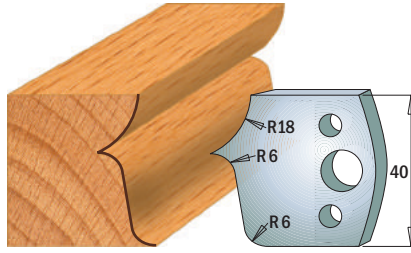

Pair of knives **690.046**  
Pair of limiters **691.046**

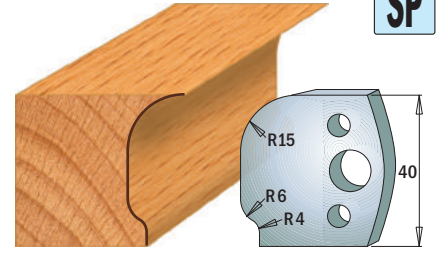

Pair of knives **690.047**  
Pair of limiters **691.047**

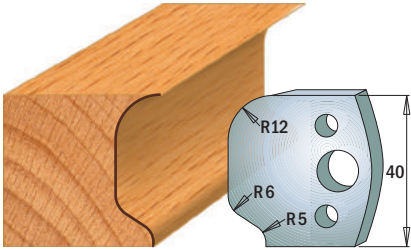

Pair of knives **690.048**  
Pair of limiters **691.048**

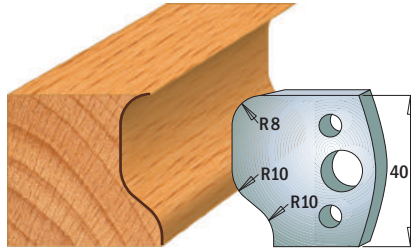

Pair of knives **690.049**  
Pair of limiters **691.049**

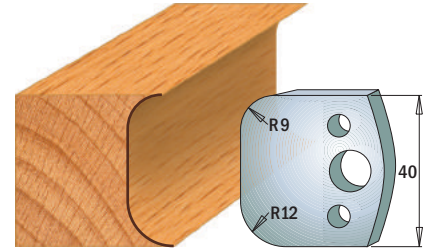

Pair of knives **690.050**  
Pair of limiters **691.050**

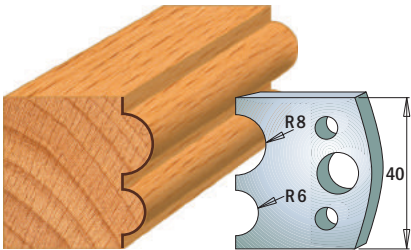

Pair of knives **690.051**  
Pair of limiters **691.051**

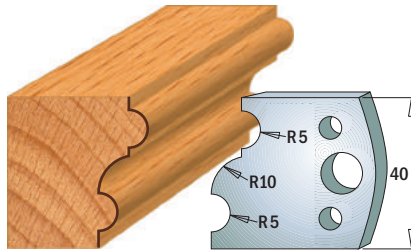

Pair of knives **690.052**  
Pair of limiters **691.052**

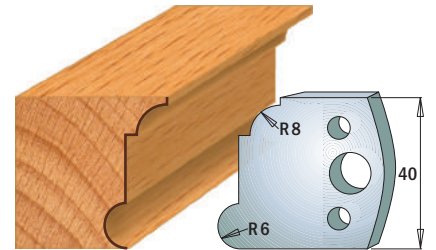

Pair of knives **690.053**  
Pair of limiters **691.053**

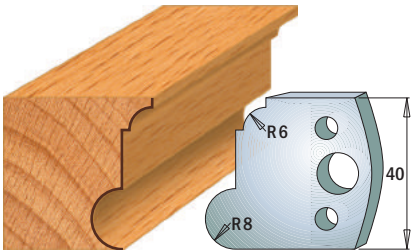

Pair of knives **690.054**  
Pair of limiters **691.054**

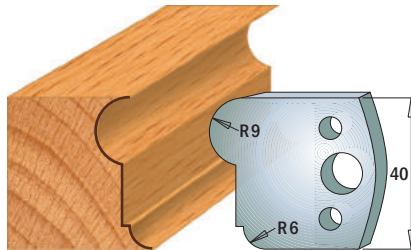

Pair of knives **690.055**  
Pair of limiters **691.055**

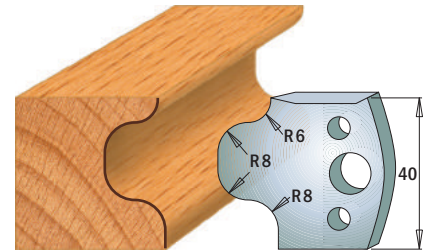

Pair of knives **690.056**  
Pair of limiters **691.056**

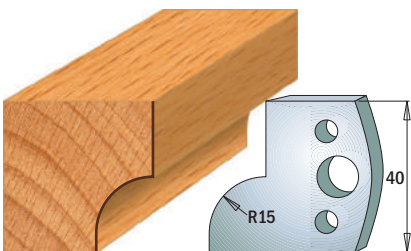

Pair of knives **690.057**  
Pair of limiters **691.057**

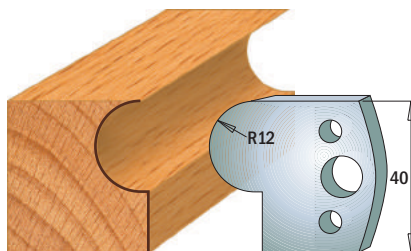

Pair of knives **690.058**  
Pair of limiters **691.058**

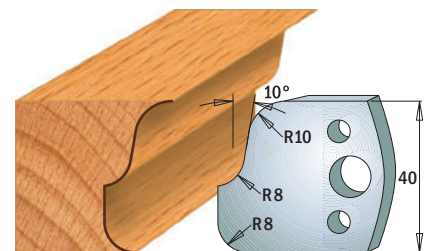

Pair of knives **690.059**  
Pair of limiters **691.059**

**NOTE:** all knives & limiters available only in pairs

Drawings are 1:2 scale

Dimensions in mm.



# Profile Knives and Limiters

Cutting Length=40mm Thickness=4mm

Pack Qty. 10



SP

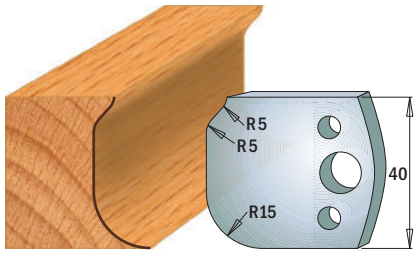

Pair of knives **690.060**  
Pair of limiters **691.060**

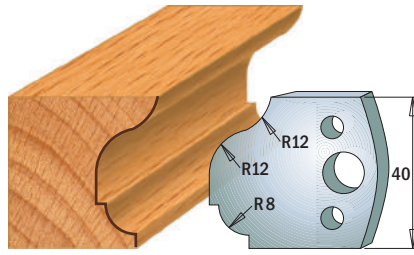

Pair of knives **690.061**  
Pair of limiters **691.061**

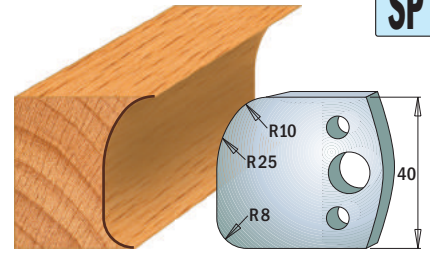

Pair of knives **690.062**  
Pair of limiters **691.062**

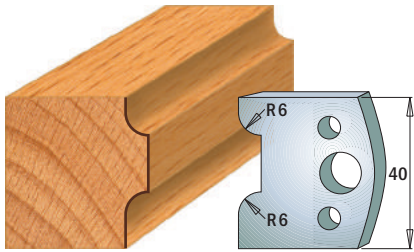

Pair of knives **690.063**  
Pair of limiters **691.063**

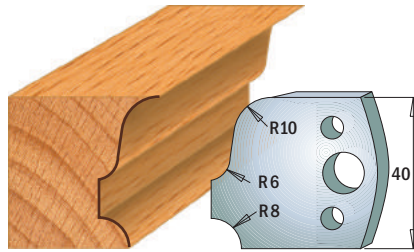

Pair of knives **690.064**  
Pair of limiters **691.064**

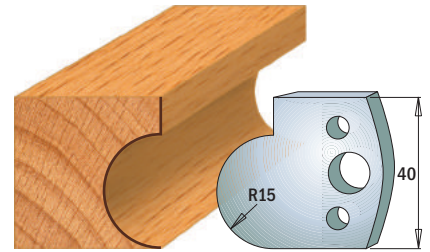

Pair of knives **690.065**  
Pair of limiters **691.065**

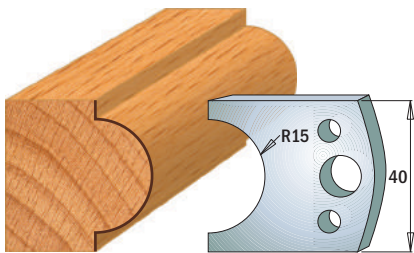

Pair of knives **690.066**  
Pair of limiters **691.066**

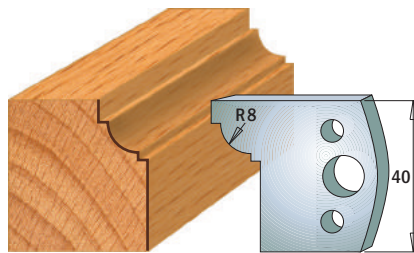

Pair of knives **690.067**  
Pair of limiters **691.067**

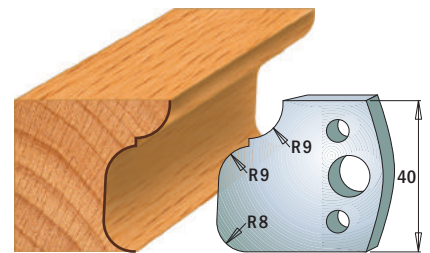

Pair of knives **690.068**  
Pair of limiters **691.068**

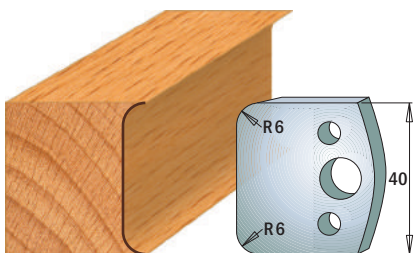

Pair of knives **690.069**  
Pair of limiters **691.069**

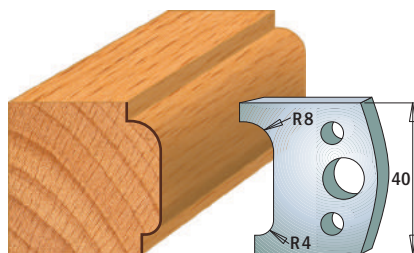

Pair of knives **690.070**  
Pair of limiters **691.070**

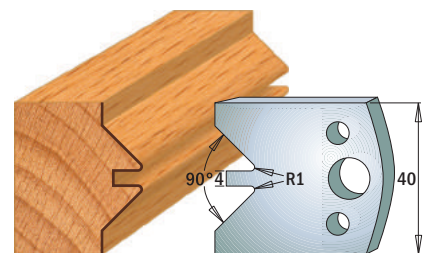

Pair of knives **690.071**  
Pair of limiters **691.071**

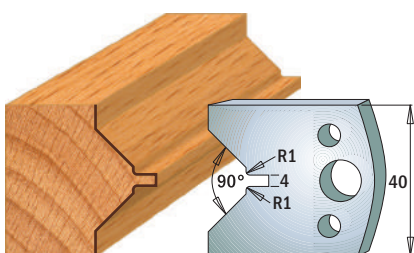

Pair of knives **690.072**  
Pair of limiters **691.072**

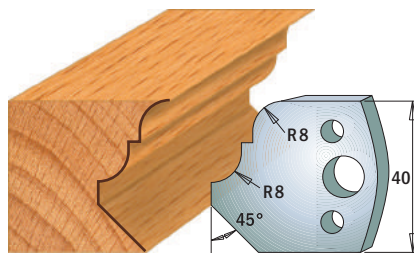

Pair of knives **690.073**  
Pair of limiters **691.073**

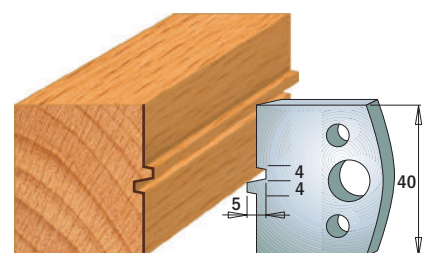

Pair of knives **690.074**  
Pair of limiters **691.074**

**NOTE:** all knives & limiters available only in pairs

Drawings are 1:2 scale

Dimensions in mm.



# Profile Knives and Limiters

Cutting Length=40mm Thickness=4mm

Pack Qty. 10



SP

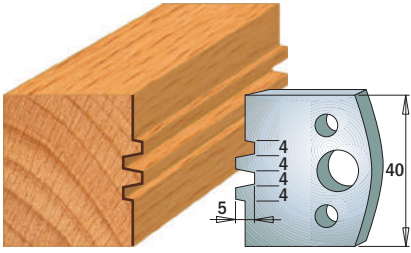

Pair of knives **690.075**  
Pair of limiters **691.075**

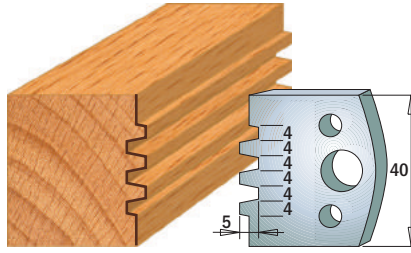

Pair of knives **690.076**  
Pair of limiters **691.076**

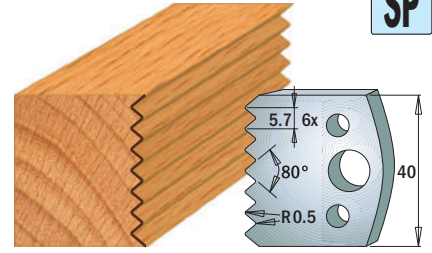

Pair of knives **690.077**  
Pair of limiters **691.077**

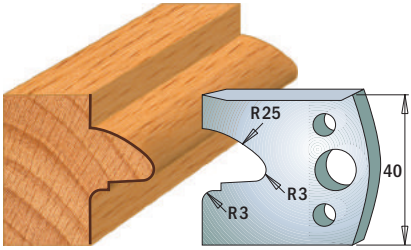

Pair of knives **690.078**  
Pair of limiters **691.078**

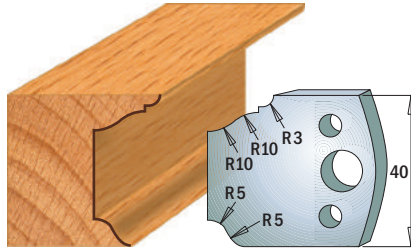

Pair of knives **690.079**  
Pair of limiters **691.079**

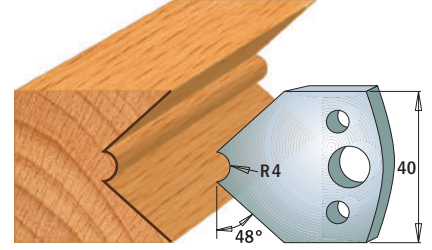

Pair of knives **690.080**  
Pair of limiters **691.080**

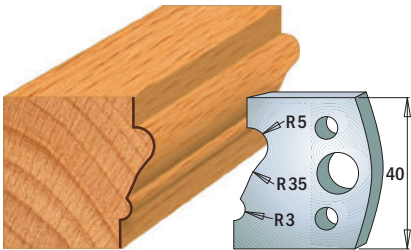

Pair of knives **690.081**  
Pair of limiters **691.081**

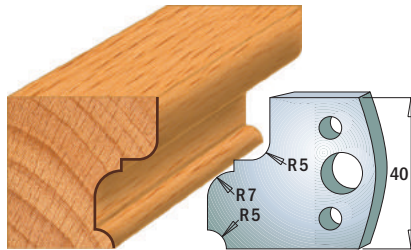

Pair of knives **690.082**  
Pair of limiters **691.082**

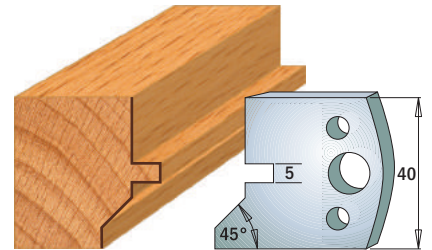

Pair of knives **690.083**  
Pair of limiters **691.083**

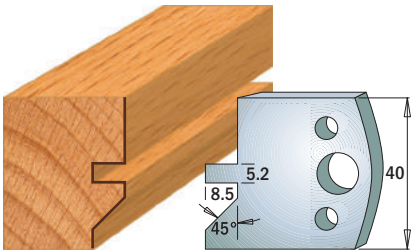

Pair of knives **690.084**  
Pair of limiters **691.084**

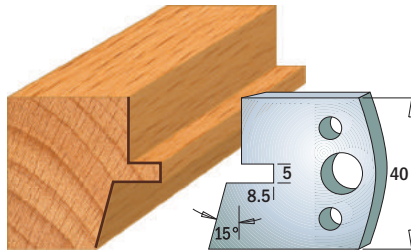

Pair of knives **690.085**  
Pair of limiters **691.085**

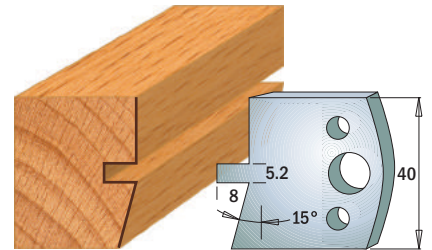

Pair of knives **690.086**  
Pair of limiters **691.086**

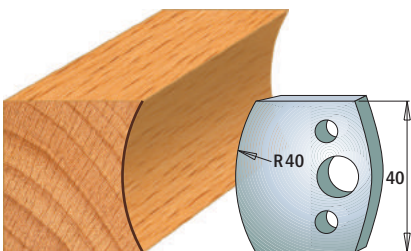

Pair of knives **690.087**  
Pair of limiters **691.087**

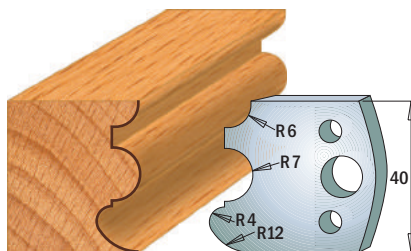

Pair of knives **690.088**  
Pair of limiters **691.088**

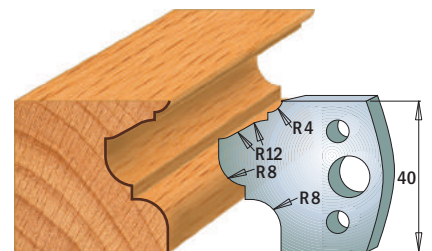

Pair of knives **690.089**  
Pair of limiters **691.089**

**NOTE:** all knives & limiters available only in pairs

Drawings are 1:2 scale

Dimensions in mm.



# Profile Knives and Limiters

Cutting Length=40mm

Thickness=4mm

Pack Qty. 10



SP

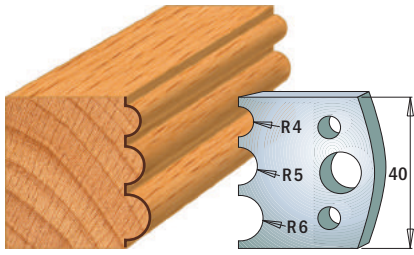

Pair of knives **690.090**  
Pair of limiters **691.090**

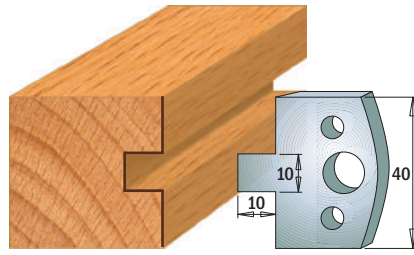

Pair of knives **690.091**  
Pair of limiters **691.091**

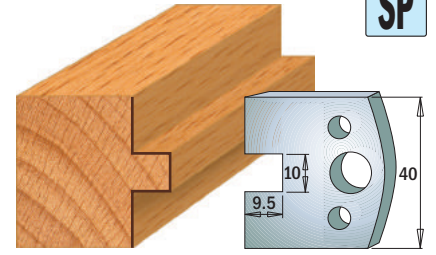

Pair of knives **690.092**  
Pair of limiters **691.092**

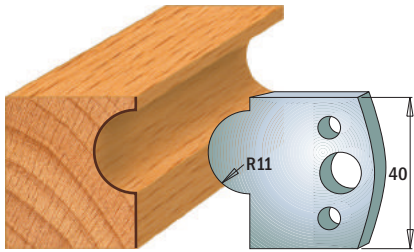

Pair of knives **690.093**  
Pair of limiters **691.093**

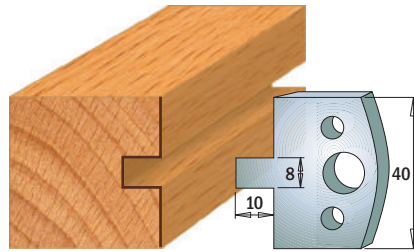

Pair of knives **690.094**  
Pair of limiters **691.094**

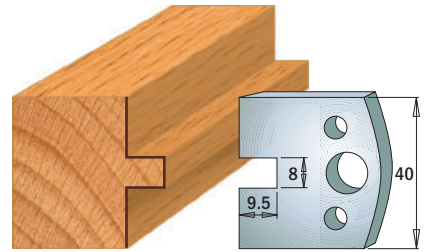

Pair of knives **690.095**  
Pair of limiters **691.095**

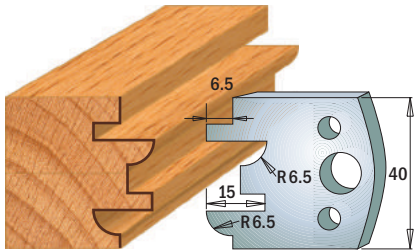

Pair of knives **690.096**  
Pair of limiters **691.096**

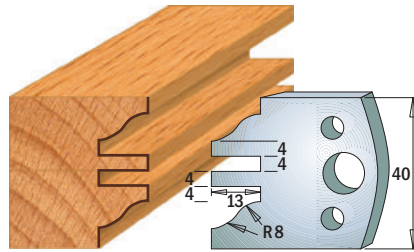

Pair of knives **690.097**  
Pair of limiters **691.097**

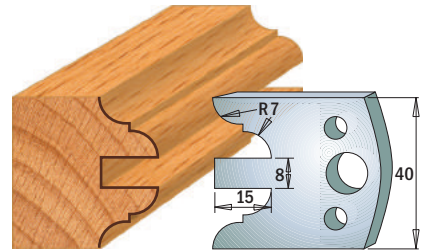

Pair of knives **690.098**  
Pair of limiters **691.098**

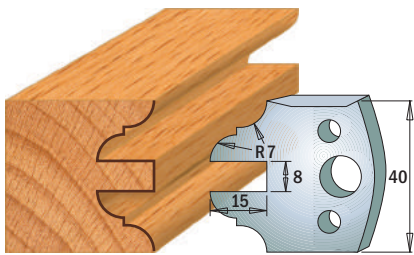

Pair of knives **690.099**  
Pair of limiters **691.099**

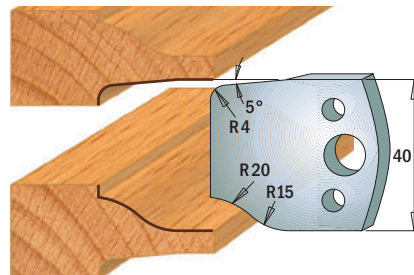

Pair of knives **690.100**  
Pair of limiters **691.100**

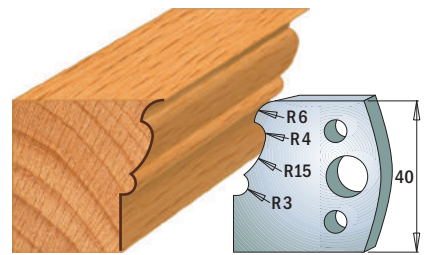

Pair of knives **690.101**  
Pair of limiters **691.101**

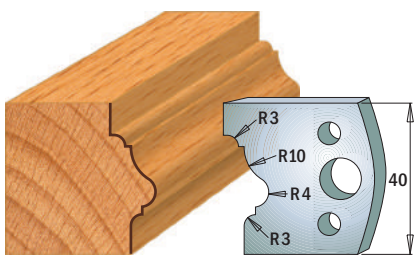

Pair of knives **690.102**  
Pair of limiters **691.102**

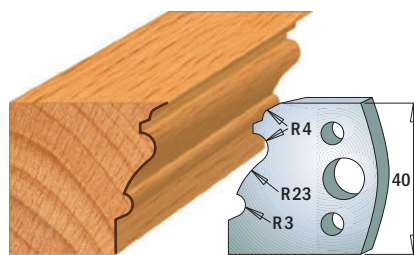

Pair of knives **690.103**  
Pair of limiters **691.103**

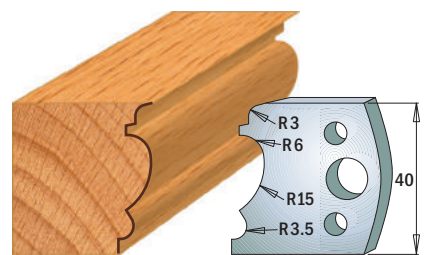

Pair of knives **690.104**  
Pair of limiters **691.104**

**NOTE:** all knives & limiters available only in pairs

Drawings are 1:2 scale

Dimensions in mm.



# Profile Knives and Limiters

Cutting Length=40mm Thickness=4mm

Pack Qty. 10



SP

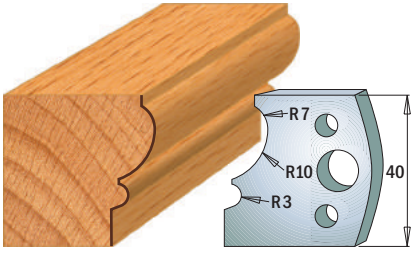

Pair of knives **690.105**  
Pair of limiters **691.105**

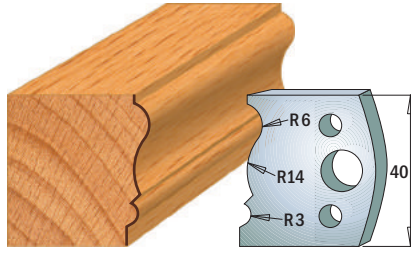

Pair of knives **690.106**  
Pair of limiters **691.106**

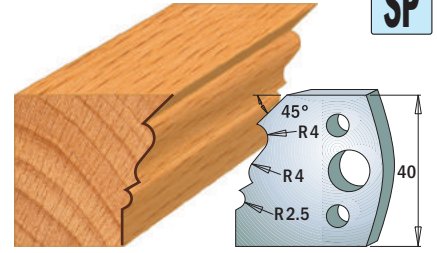

Pair of knives **690.107**  
Pair of limiters **691.107**

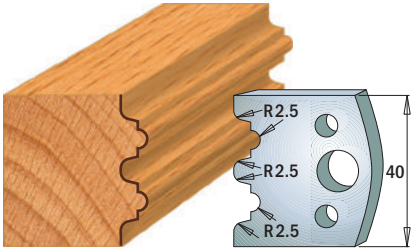

Pair of knives **690.108**  
Pair of limiters **691.108**

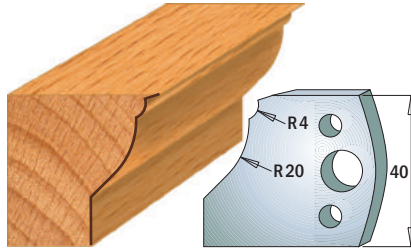

Pair of knives **690.109**  
Pair of limiters **691.109**

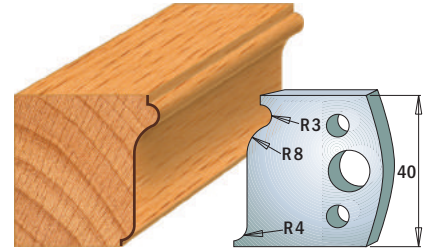

Pair of knives **690.110**  
Pair of limiters **691.110**

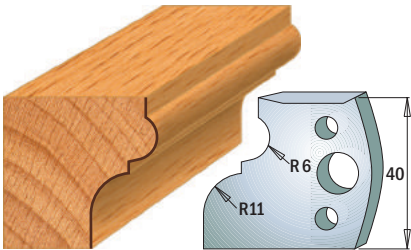

Pair of knives **690.111**  
Pair of limiters **691.111**

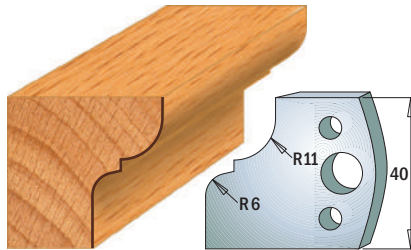

Pair of knives **690.112**  
Pair of limiters **691.112**

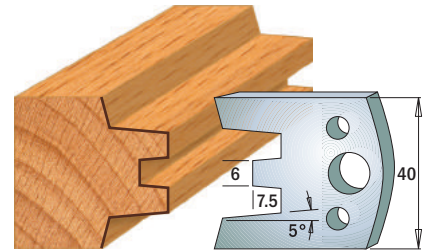

Pair of knives **690.113**  
Pair of limiters **691.113**

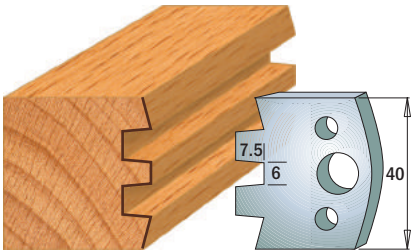

Pair of knives **690.114**  
Pair of limiters **691.114**

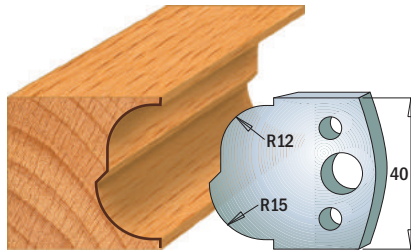

Pair of knives **690.115**  
Pair of limiters **691.115**

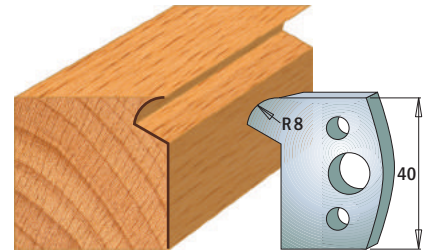

Pair of knives **690.116**  
Pair of limiters **691.116**

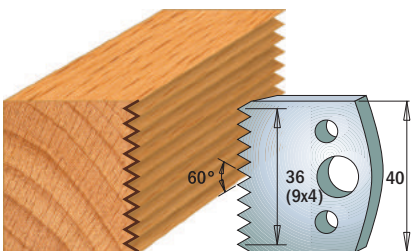

Pair of knives **690.117**  
Pair of limiters **691.117**

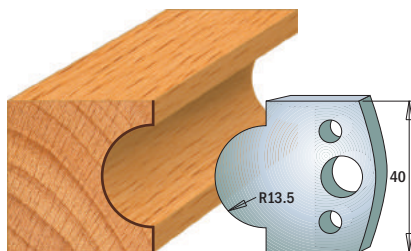

Pair of knives **690.118**  
Pair of limiters **691.118**

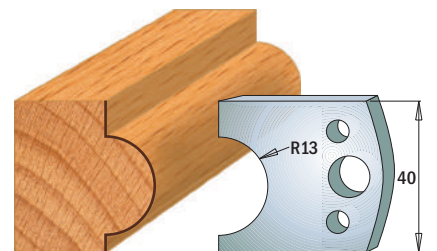

Pair of knives **690.119**  
Pair of limiters **691.119**

**NOTE:** all knives & limiters available only in pairs

Drawings are 1:2 scale

Dimensions in mm.



# Profile Knives and Limiters

Cutting Length=40mm

Thickness=4mm

Pack Qty. 10



SP

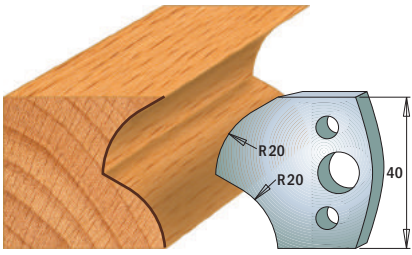

Pair of knives **690.120**  
Pair of limiters **691.120**

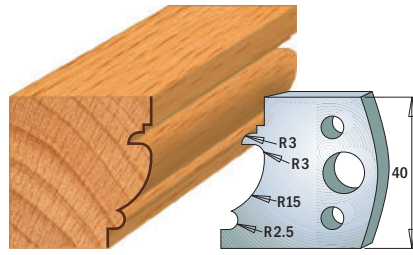

Pair of knives **690.121**  
Pair of limiters **691.121**

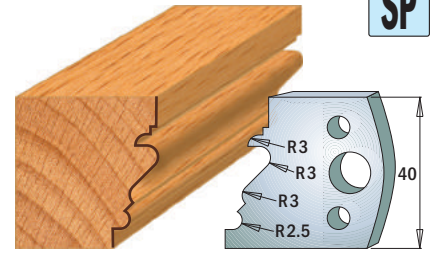

Pair of knives **690.122**  
Pair of limiters **691.122**

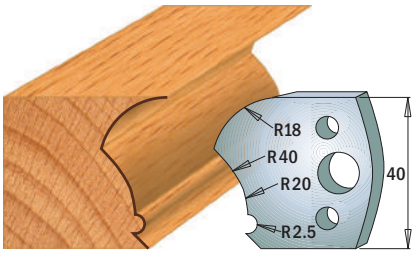

Pair of knives **690.123**  
Pair of limiters **691.123**

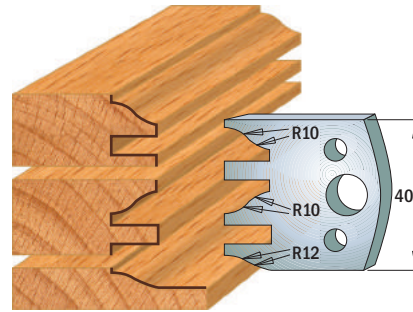

Pair of knives **690.124**  
Pair of limiters **691.124**

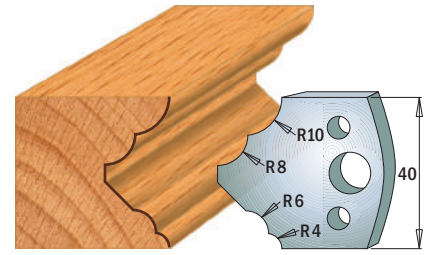

Pair of knives **690.125**  
Pair of limiters **691.125**

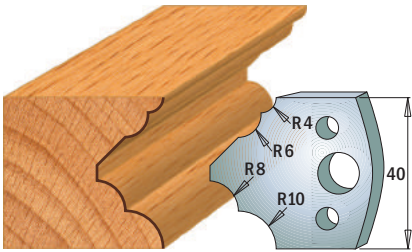

Pair of knives **690.126**  
Pair of limiters **691.126**

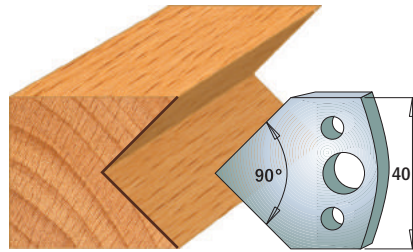

Pair of knives **690.127**  
Pair of limiters **691.127**

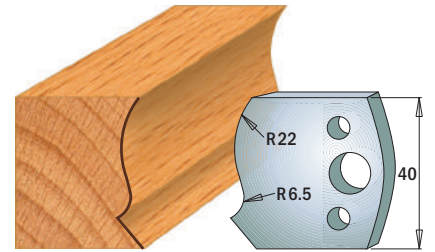

Pair of knives **690.128**  
Pair of limiters **691.128**

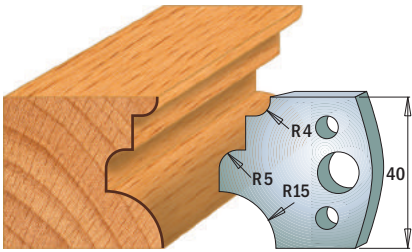

Pair of knives **690.129**  
Pair of limiters **691.129**

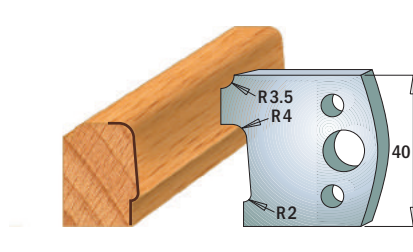

Pair of knives **690.130**  
Pair of limiters **691.130**

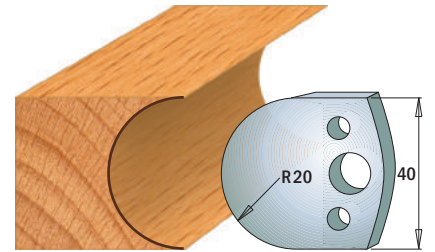

Pair of knives **690.131**  
Pair of limiters **691.131**

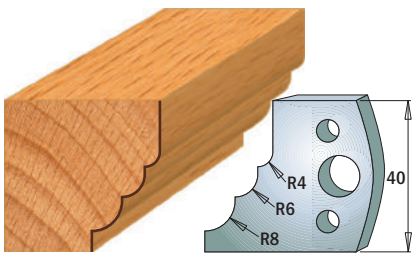

Pair of knives **690.132**  
Pair of limiters **691.132**

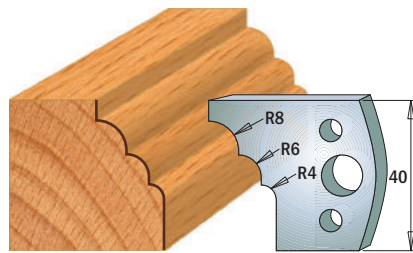

Pair of knives **690.133**  
Pair of limiters **691.133**

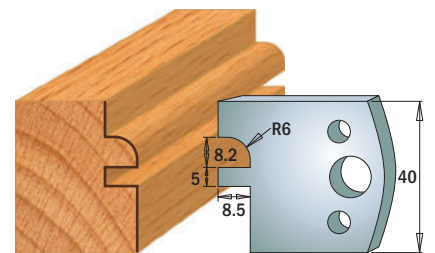

Pair of knives **690.134**  
Pair of limiters **691.134**

**NOTE:** all knives & limiters available only in pairs

Drawings are 1:2 scale

Dimensions in mm.



# Profile Knives and Limiters

Cutting Length=40mm Thickness=4mm

Pack Qty. 10



SP

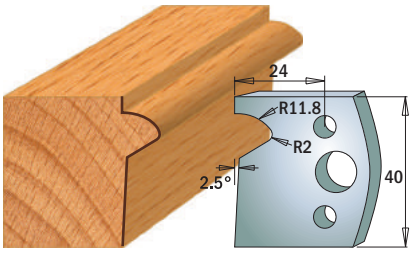

Pair of knives **690.135**  
Pair of limiters **691.135**

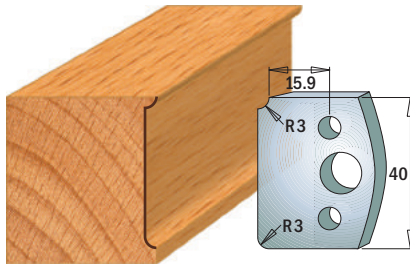

Pair of knives **690.170**  
Pair of limiters **691.170**

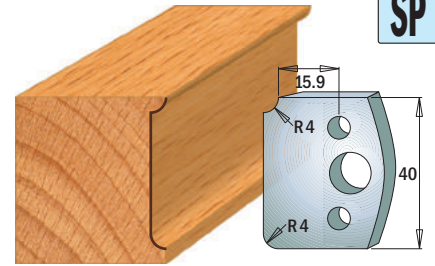

Pair of knives **690.171**  
Pair of limiters **691.171**

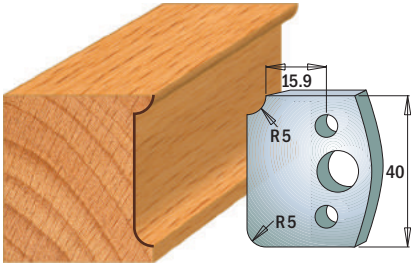

Pair of knives **690.172**  
Pair of limiters **691.172**

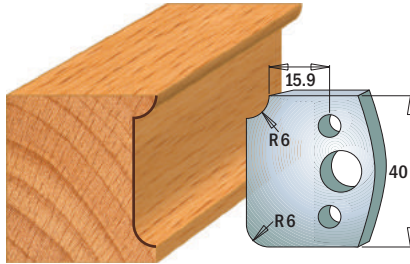

Pair of knives **690.173**  
Pair of limiters **691.173**

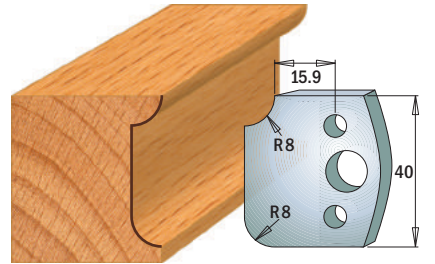

Pair of knives **690.174**  
Pair of limiters **691.174**

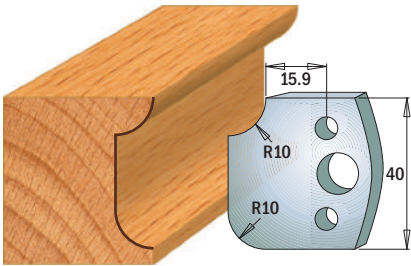

Pair of knives **690.175**  
Pair of limiters **691.175**

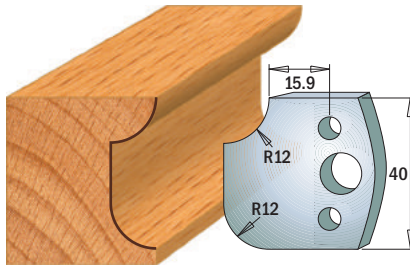

Pair of knives **690.176**  
Pair of limiters **691.176**

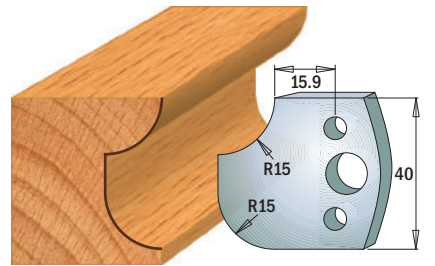

Pair of knives **690.177**  
Pair of limiters **691.177**

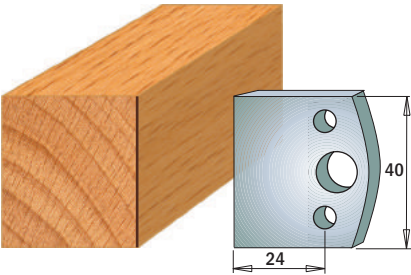

Pair of knives **690.192**  
Pair of limiters **691.192**

## Profile Knives and Limiters

Cutting Length=50mm

Thickness=4mm

Pack Qty. 10

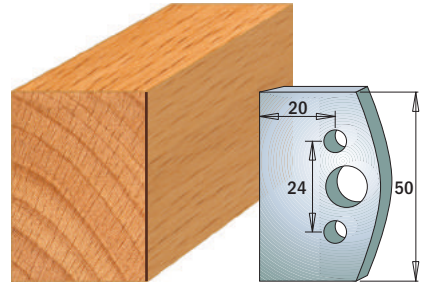

Pair of knives **690.500**  
Pair of limiters **691.500**

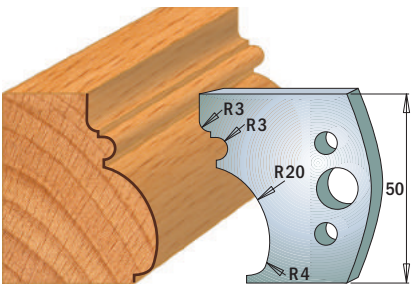

Pair of knives **690.501**  
Pair of limiters **691.501**

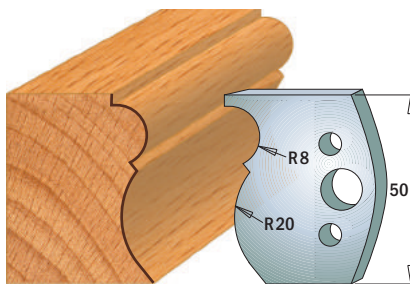

Pair of knives **690.502**  
Pair of limiters **691.502**

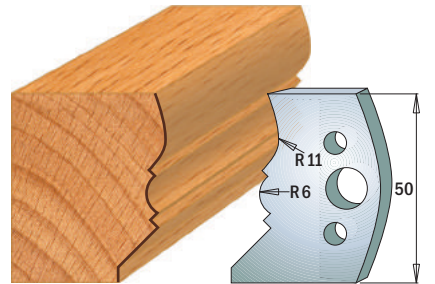

Pair of knives **690.503**  
Pair of limiters **691.503**

**NOTE:** all knives & limiters available only in pairs

Drawings are 1:2 scale

Dimensions in mm.



# Profile Knives and Limiters

Cutting Length=50mm

Thickness=4mm

Pack Qty. 10



SP

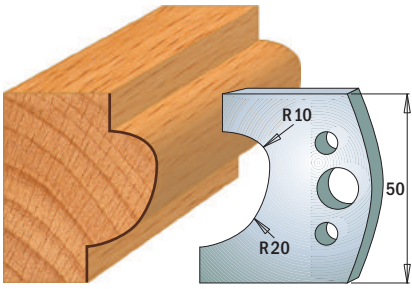

Pair of knives **690.504**  
Pair of limiters **691.504**

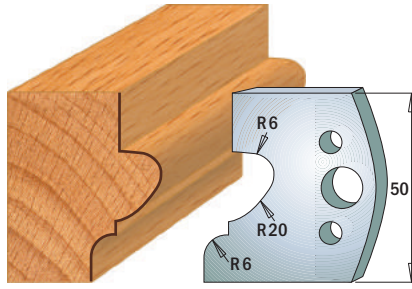

Pair of knives **690.505**  
Pair of limiters **691.505**

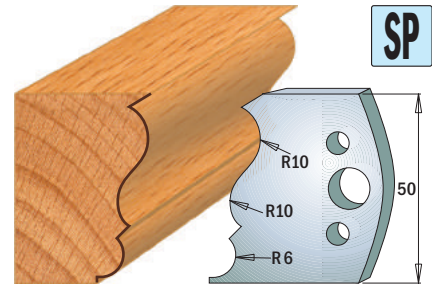

Pair of knives **690.506**  
Pair of limiters **691.506**

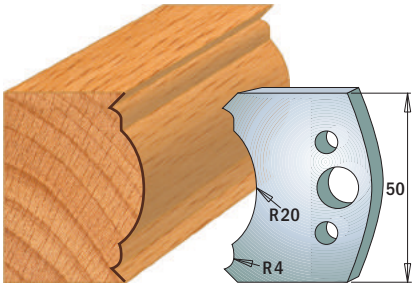

Pair of knives **690.507**  
Pair of limiters **691.507**

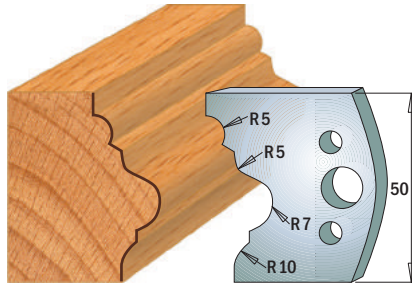

Pair of knives **690.508**  
Pair of limiters **691.508**

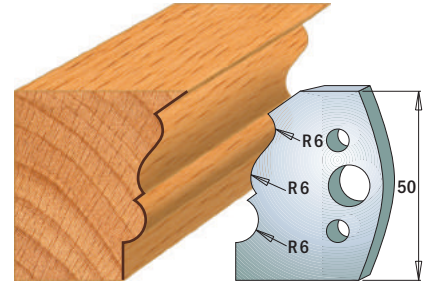

Pair of knives **690.509**  
Pair of limiters **691.509**

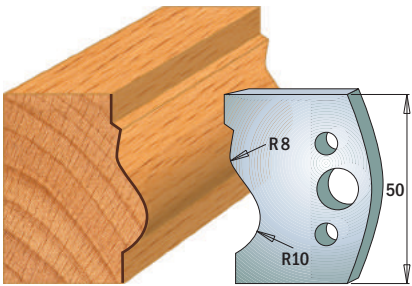

Pair of knives **690.510**  
Pair of limiters **691.510**

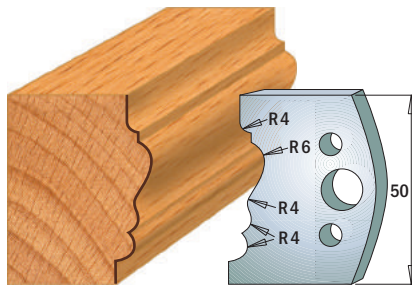

Pair of knives **690.511**  
Pair of limiters **691.511**

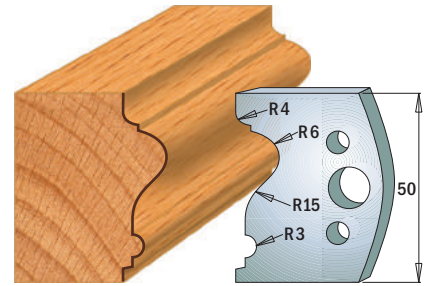

Pair of knives **690.512**  
Pair of limiters **691.512**

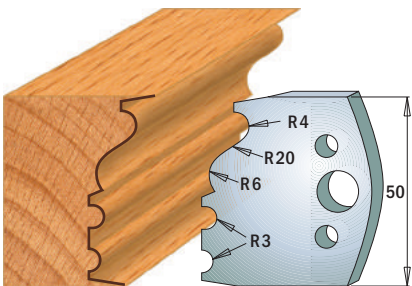

Pair of knives **690.513**  
Pair of limiters **691.513**

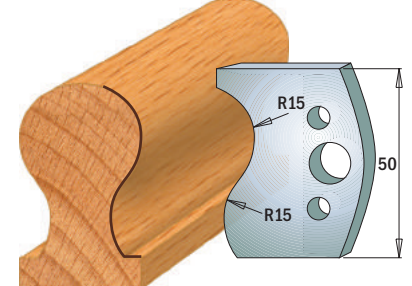

Pair of knives **690.514**  
Pair of limiters **691.514**

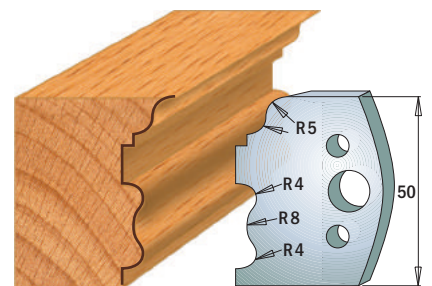

Pair of knives **690.515**  
Pair of limiters **691.515**

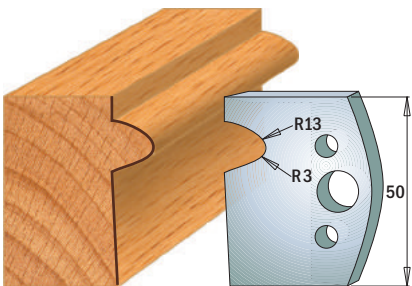

Pair of knives **690.516**  
Pair of limiters **691.516**

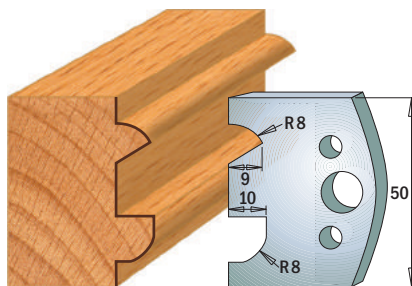

Pair of knives **690.517**  
Pair of limiters **691.517**

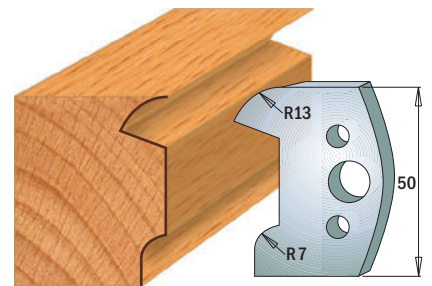

Pair of knives **690.518**  
Pair of limiters **691.518**

**NOTE:** all knives & limiters available only in pairs

Drawings are 1:2 scale

Dimensions in mm.



# Profile Knives and Limiters

Cutting Length=50mm Thickness=4mm

Pack Qty. 10



SP

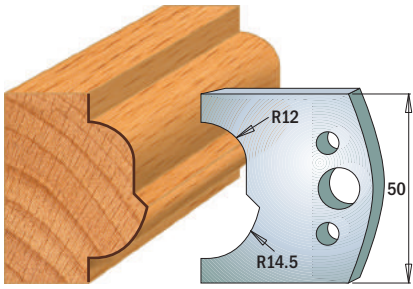

Pair of knives **690.519**  
Pair of limiters **691.519**

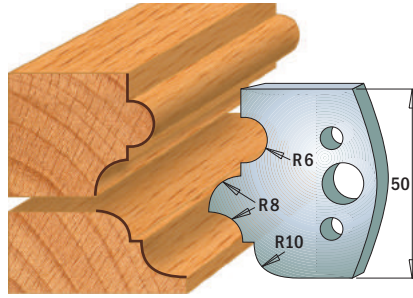

Pair of knives **690.520**  
Pair of limiters **691.520**

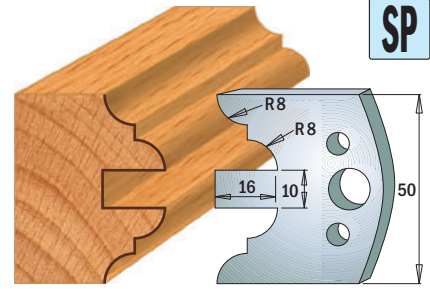

Pair of knives **690.522**  
Pair of limiters **691.522**

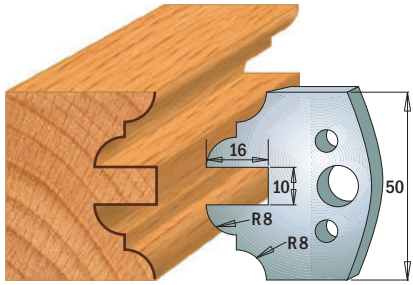

Pair of knives **690.523**  
Pair of limiters **691.523**

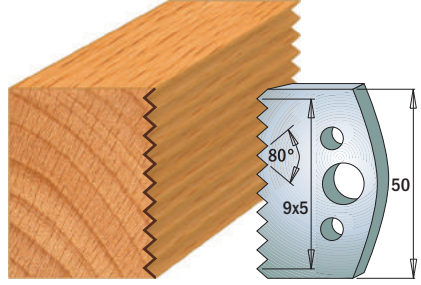

Pair of knives **690.524**  
Pair of limiters **691.524**

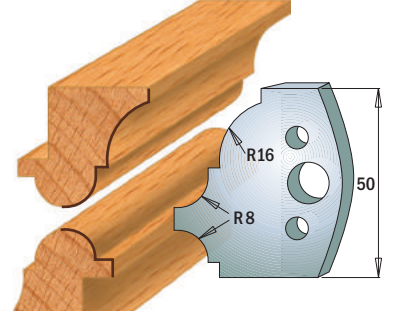

Pair of knives **690.541**  
Pair of limiters **691.541**

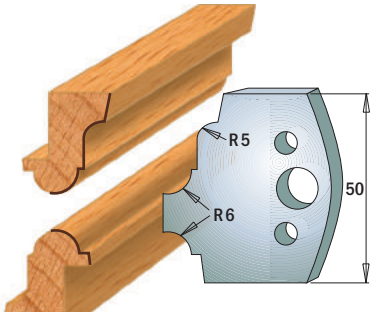

Pair of knives **690.542**  
Pair of limiters **691.542**

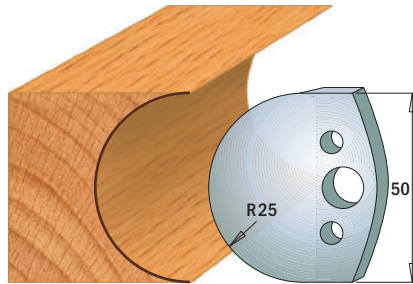

Pair of knives **690.543**  
Pair of limiters **691.543**

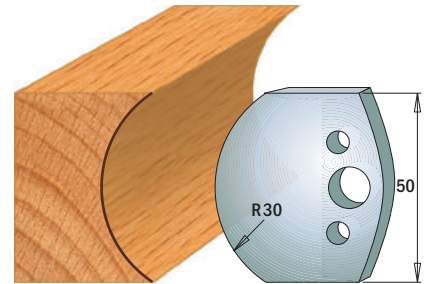

Pair of knives **690.544**  
Pair of limiters **691.544**

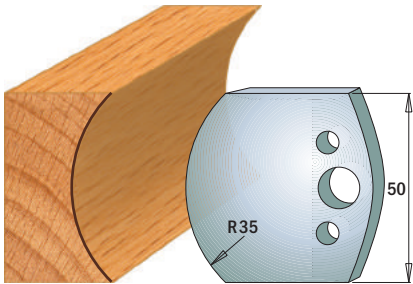

Pair of knives **690.545**  
Pair of limiters **691.545**

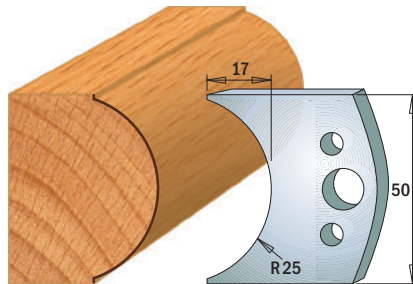

Pair of knives **690.546**  
Pair of limiters **691.546**

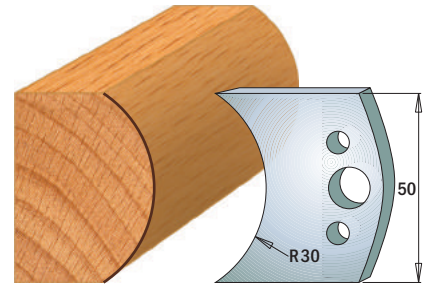

Pair of knives **690.547**  
Pair of limiters **691.547**

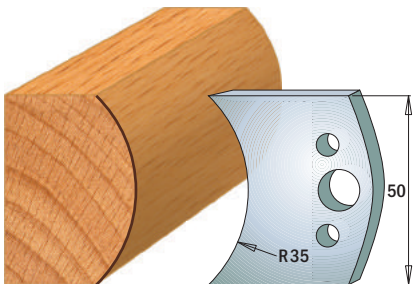

Pair of knives **690.548**  
Pair of limiters **691.548**

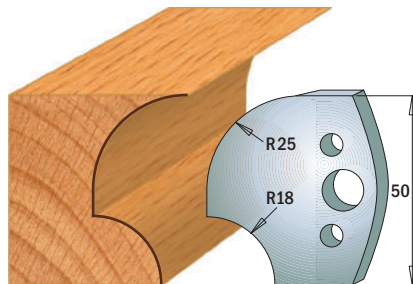

Pair of knives **690.549**  
Pair of limiters **691.549**

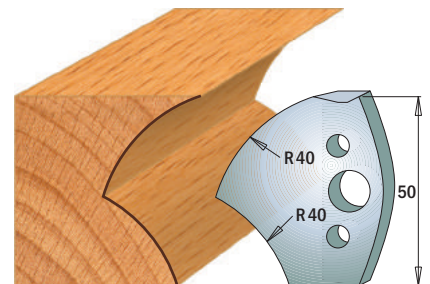

Pair of knives **690.550**  
Pair of limiters **691.550**

**NOTE:** all knives & limiters available only in pairs

Drawings are 1:2 scale

Dimensions in mm.



# Profile Knives and Limiters

Cutting Length=50mm

Thickness=4mm

Pack Qty. 10

SP

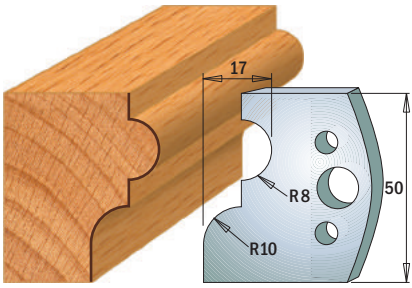

Pair of knives **690.551**  
Pair of limiters **691.551**

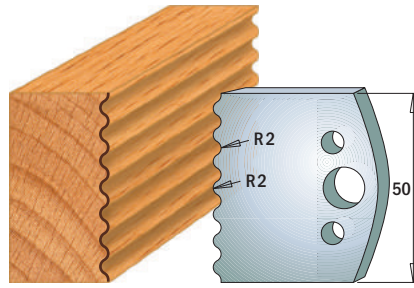

Pair of knives **690.552**  
Pair of limiters **691.552**

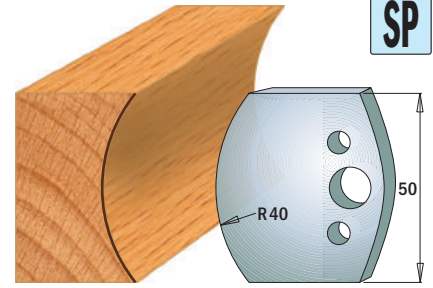

Pair of knives **690.553**  
Pair of limiters **691.553**

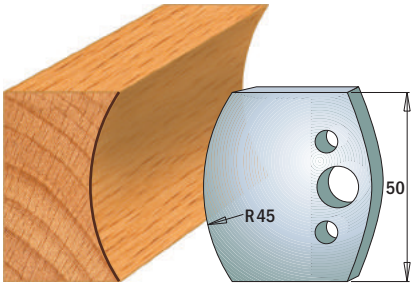

Pair of knives **690.554**  
Pair of limiters **691.554**

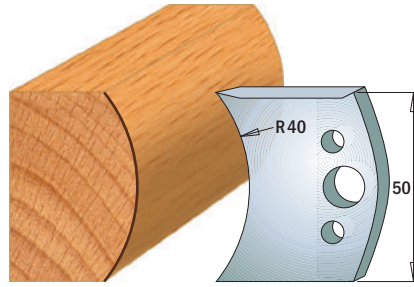

Pair of knives **690.555**  
Pair of limiters **691.555**

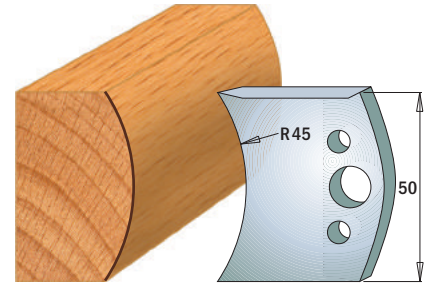

Pair of knives **690.556**  
Pair of limiters **691.556**

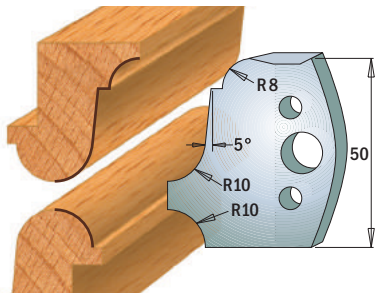

Pair of knives **690.557**  
Pair of limiters **691.557**

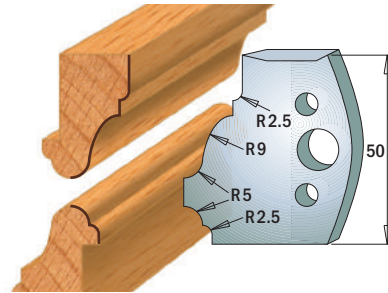

Pair of knives **690.558**  
Pair of limiters **691.558**

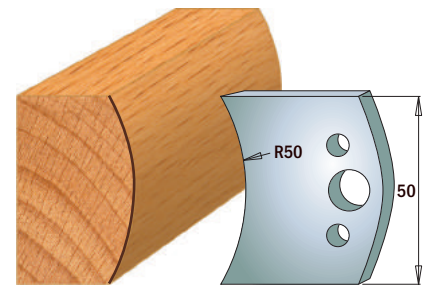

Pair of knives **690.559**  
Pair of limiters **691.559**

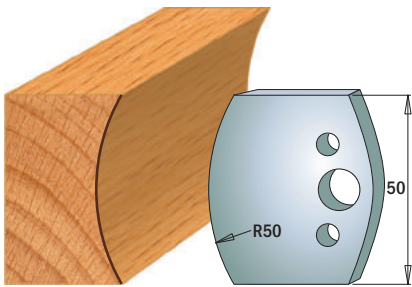

Pair of knives **690.560**  
Pair of limiters **691.560**

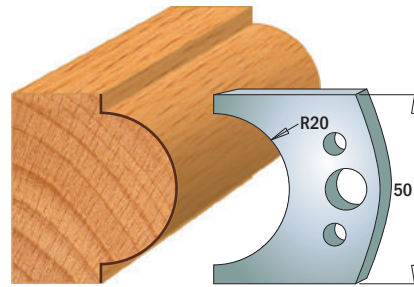

Pair of knives **690.561**  
Pair of limiters **691.561**

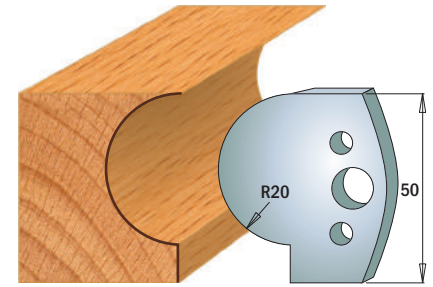

Pair of knives **690.562**  
Pair of limiters **691.562**

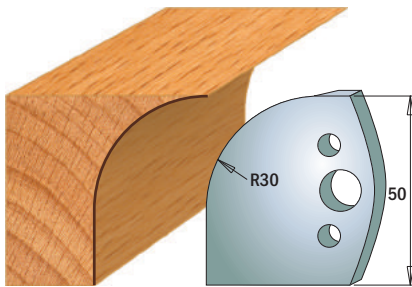

Pair of knives **690.563**  
Pair of limiters **691.563**

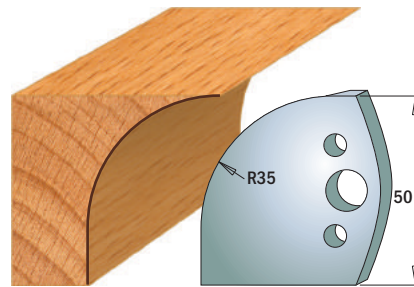

Pair of knives **690.564**  
Pair of limiters **691.564**

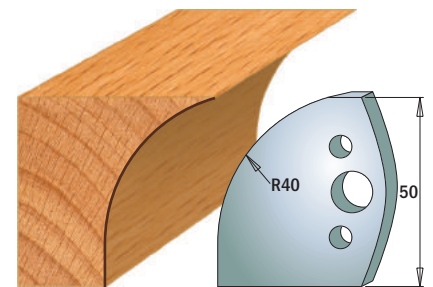

Pair of knives **690.565**  
Pair of limiters **691.565**

**NOTE:** all knives & limiters available only in pairs

Drawings are 1:2 scale

Dimensions in mm.



# Profile Knives and Limiters

Cutting Length=50mm Thickness=4mm

Pack Qty. 10

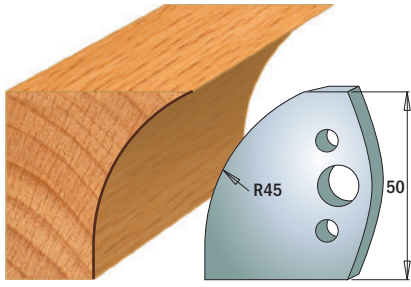

Pair of knives **690.566**  
Pair of limiters **691.566**

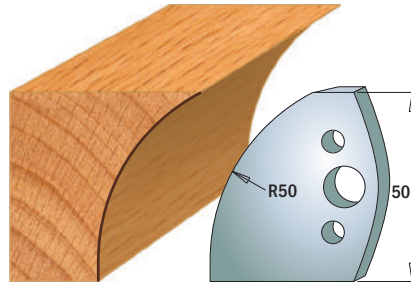

Pair of knives **690.567**  
Pair of limiters **691.567**

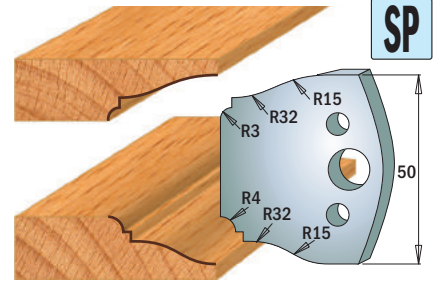

Pair of knives **690.568**  
Pair of limiters **691.568**

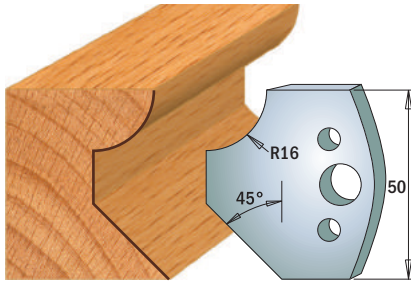

Pair of knives **690.569**  
Pair of limiters **691.569**

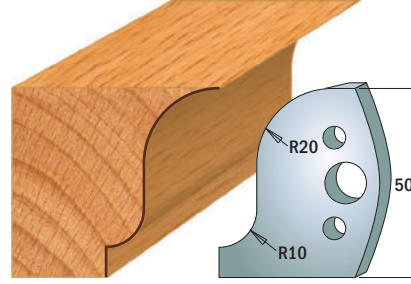

Pair of knives **690.570**  
Pair of limiters **691.570**

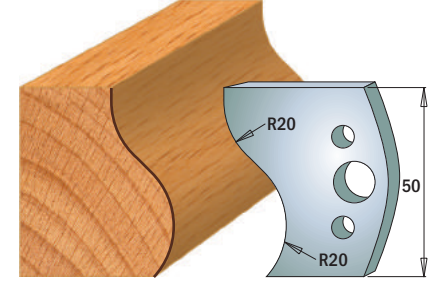

Pair of knives **690.571**  
Pair of limiters **691.571**

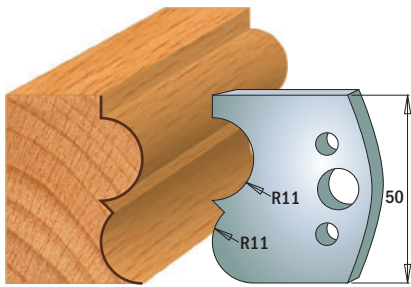

Pair of knives **690.572**  
Pair of limiters **691.572**

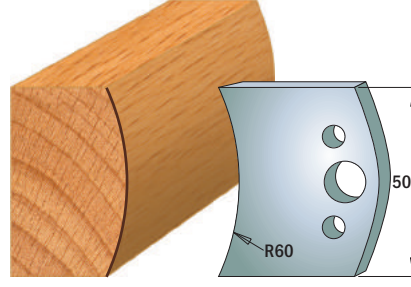

Pair of knives **690.573**  
Pair of limiters **691.573**

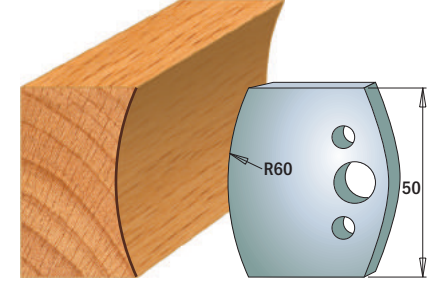

Pair of knives **690.574**  
Pair of limiters **691.574**

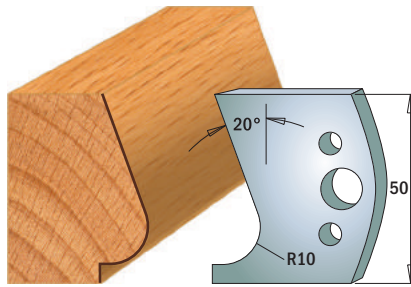

Pair of knives **690.575**  
Pair of limiters **691.575**

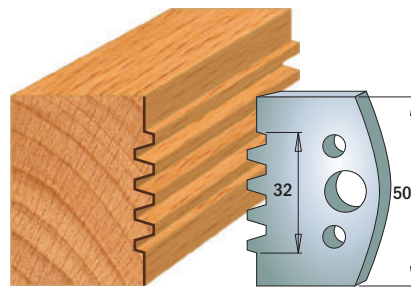

Pair of knives **690.576**  
Pair of limiters **691.576**

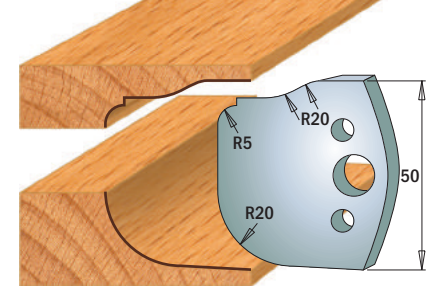

Pair of knives **690.577**  
Pair of limiters **691.577**

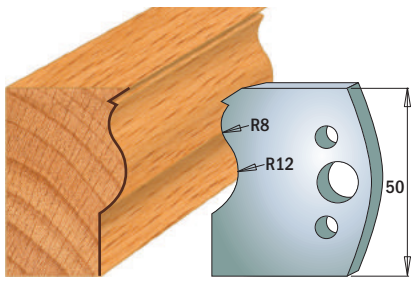

Pair of knives **690.578**  
Pair of limiters **691.578**

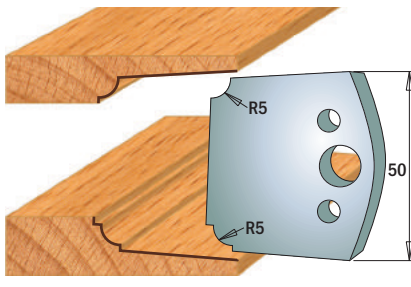

Pair of knives **690.579**  
Pair of limiters **691.579**

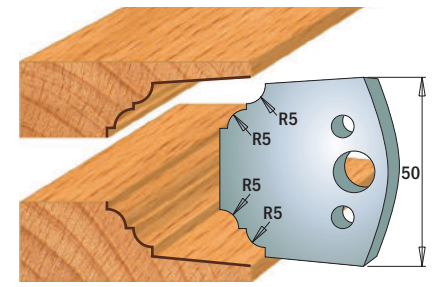

Pair of knives **690.580**  
Pair of limiters **691.580**

**NOTE:** all knives & limiters available only in pairs

Drawings are 1:2 scale

Dimensions in mm.

Blank Knives & Limiters (to be sharpened)

**SP HSS**

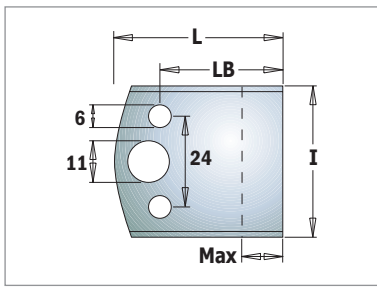

**690-691**

DESCRIPTION	I mm	LB mm	L mm	Max mm		ORDER NO. SP	ORDER NO. HSS
Pair of knives	40	32,5	44,5	18	10	<b>690.193</b>	<b>690.193H</b>
Pair of knives	50	34	46	20	10	<b>690.599</b>	<b>690.599H</b>
Pair of limiters	38	16	28	2	10	<b>691.190</b>	
Pair of limiters	38	24	36	10	10	<b>691.192</b>	
Pair of limiters	38	32,5	44,5	18	10		<b>691.193</b>
Pair of limiters	48	34	46	20	10	<b>691.599</b>	

Pair of Bore Reducers

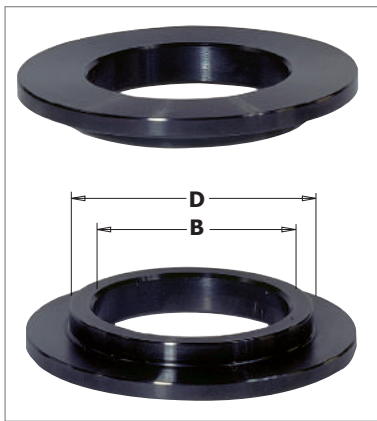

**699**

D mm	B mm		ORDER NO.	D mm	B mm		ORDER NO.
19,05	12,7	10	<b>699.019.13</b>	35	32	10	<b>699.035.32</b>
25,4	19,05	10	<b>699.026.19</b>	40	30	10	<b>699.040.30</b>
30	19,05	10	<b>699.030.19</b>	40	32	10	<b>699.040.32</b>
30	25,4	10	<b>699.030.26</b>	40	35	10	<b>699.040.35</b>
31,75	19,05	10	<b>699.031.19</b>	50	30	1	<b>699.050.30</b>
31,75	25,4	10	<b>699.031.26</b>	50	32	1	<b>699.050.32</b>
31,75	30	10	<b>699.031.30</b>	50	35	1	<b>699.050.35</b>
35	30	10	<b>699.035.30</b>	50	40	1	<b>699.050.40</b>
35	31,75	10	<b>699.035.31</b>				

For use only paired.

Chucks & "ER20" Collets for Spindle Moulder Machine

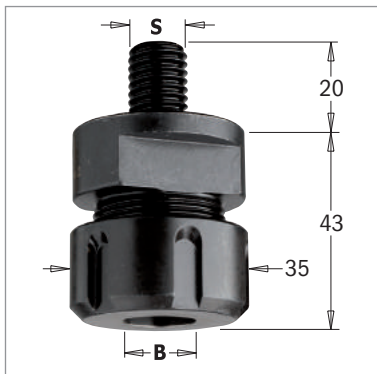

**796**

S mm	B mm	L mm		ORDER NO.
M12x1,75	3 ~ 12,7	43	10	<b>796.122.00</b>
M14x2	3 ~ 12,7	43	10	<b>796.142.00</b>
M16x2	3 ~ 12,7	43	10	<b>796.162.00</b>

**Spare parts** 992.483.03 M25x1,5mm clamping nut  
991.483.00 "ER20" key

**TECHNICAL DETAILS:**  
Super strength steel.  
Precisely machined for accuracy.

**Collet not included.**

"ER20" Precision Collets for 796.122/142/162 Items

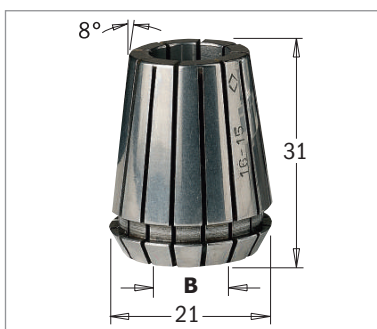

**184**

B mm		ORDER NO.	B mm		ORDER NO.
2	10	<b>184.020.20</b>	8	10	<b>184.080.20</b>
3	10	<b>184.030.20</b>	9	10	<b>184.090.20</b>
4	10	<b>184.040.20</b>	10	10	<b>184.100.20</b>
5	10	<b>184.050.20</b>	11	10	<b>184.110.20</b>
6	10	<b>184.060.20</b>	12	10	<b>184.120.20</b>
6,35	10	<b>184.064.20</b>	12,7	10	<b>184.127.20</b>
7	10	<b>184.070.20</b>			

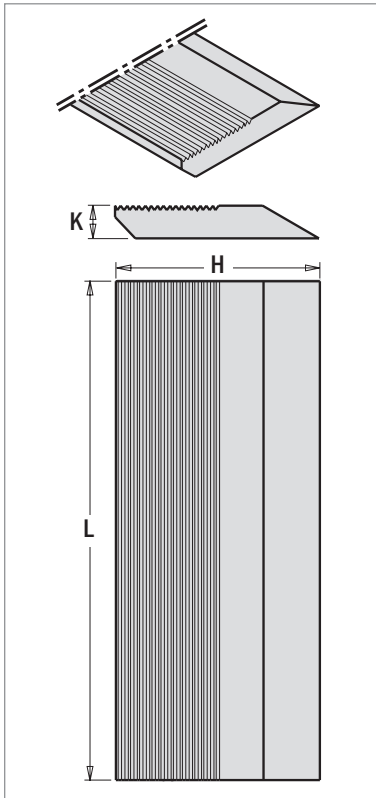

IN QUADROPACK PACKAGING  
4 KNIVES FOR EACH SET

MATERIAL	HSS
Dry softwood	●
Wet softwood	●
Dry hardwood	●
Wet hardwood	○

- Suitable
- Party suitable

## 793

L mm	H mm	K mm	ORDER NO. pieces for each set		ORDER NO. HSS
40 x	50 x	8	4	1	793.040.50
40 x	60 x	8	4	1	793.040.60
40 x	70 x	8	4	1	793.040.70
60 x	50 x	8	4	1	793.060.50
60 x	60 x	8	4	1	793.060.60
60 x	70 x	8	4	1	793.060.70
80 x	50 x	8	4	1	793.080.50
80 x	60 x	8	4	1	793.080.60
80 x	70 x	8	4	1	793.080.70
100 x	50 x	8	4	1	793.100.50
100 x	60 x	8	4	1	793.100.60
100 x	70 x	8	4	1	793.100.70
120 x	50 x	8	4	1	793.120.50
120 x	60 x	8	4	1	793.120.60
120 x	70 x	8	4	1	793.120.70
130 x	60 x	8	4	1	793.130.60
130 x	70 x	8	4	1	793.130.70
650 x	40 x	8	4	1	793.650.40
650 x	50 x	8	4	1	793.650.50
650 x	60 x	8	4	1	793.650.60
650 x	70 x	8	4	1	793.650.70

**REMARK:** special dimensions available on request.

**TECHNICAL DETAILS:**

Corrugated back moulder knives for profile cutter heads with precise positioning, angle 60°, pitch 1,6mm.



## Set of 2 Magnetic Knife Setting Jigs



Insert your knives into the tool holders and align them perfectly with this set! Perfect micro adjustments on will guarantee excellent cutting performance!

1. MAGNETIC STOP
2. JOINTS WITH MAGNETIC CONNECTORS
3. LOCK SCREW

## CMT792

2 setup possibilities

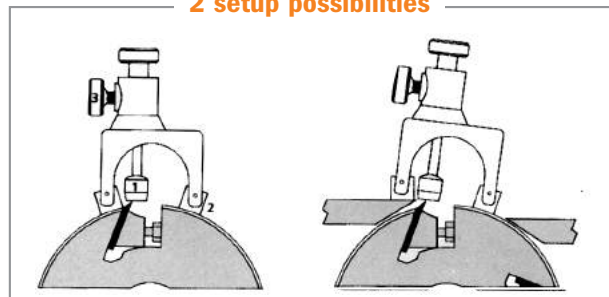

Positioning on the tool holder body with detection of the knife position.

Direct positioning on both the planer table and the tool holder body with detection of the knife position.

DESCRIPTION		ORDER NO.
Set of 2 magnetic knife setting jigs	25	CMT792



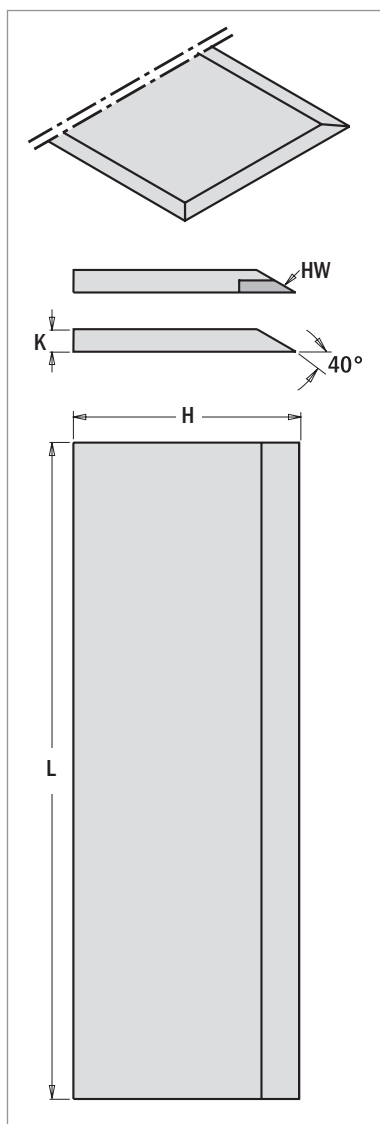

IN QUADROPACK PACKAGING  
2 KNIVES FOR EACH SET

\* The HSS knives are balanced and milled.

MATERIAL	SP	HSS	HW
Dry softwood	○	●	
Wet softwood	○	○	
Dry hardwood	○	●	●
Wet hardwood	○	●	○
Chipboard			○
MDF			○
Glulam		○	●
Solid surface			○

- Suitable
- Party suitable

## 792

L mm	H mm	K mm	KNIVES pieces for each set		ORDER NO. SP	ORDER NO. HSS*	ORDER NO. HW
120 x	30 x	3	2	1		792.120.30	
130 x	30 x	3	2	1	792.131.30	792.130.30	792.132.30
150 x	30 x	3	2	1		792.150.30	
180 x	30 x	3	2	1	792.181.30	792.180.30	792.182.30
200 x	30 x	3	2	1	792.201.30	792.200.30	
210 x	30 x	3	2	1	792.211.30	792.210.30	
230 x	30 x	3	2	1	792.231.30	792.230.30	792.232.30
250 x	30 x	3	2	1	792.251.30	792.250.30	792.252.30
260 x	30 x	3	2	1	792.261.30	792.260.30	792.262.30
300 x	30 x	3	2	1	792.301.30	792.300.30	792.302.30
310 x	30 x	3	2	1	792.311.30	792.310.30	792.312.30
350 x	30 x	3	2	1	792.351.30	792.350.30	792.352.30
400 x	30 x	3	2	1	792.401.30	792.400.30	792.402.30
410 x	30 x	3	2	1	792.411.30	792.410.30	792.412.30
430 x	30 x	3	2	1	792.431.30	792.430.30	792.432.30
450 x	30 x	3	2	1	792.451.30	792.450.30	792.452.30
500 x	30 x	3	2	1	792.501.30	792.500.30	792.502.30
510 x	30 x	3	2	1	792.511.30	792.510.30	792.512.30
520 x	30 x	3	2	1	792.521.30	792.520.30	792.522.30
530 x	30 x	3	2	1	792.531.30	792.530.30	792.532.30
600 x	30 x	3	2	1	792.601.30	792.600.30	792.602.30
610 x	30 x	3	2	1	792.611.30	792.610.30	792.612.30
630 x	30 x	3	2	1	792.631.30	792.630.30	792.632.30
640 x	30 x	3	2	1		792.640.30	
710 x	30 x	3	2	1		792.710.30	
810 x	30 x	3	2	1	792.811.30	792.810.30	792.812.30
1050 x	30 x	3	2	1	792.998.30	792.997.30	792.999.30
300 x	35 x	3	2	1		792.300.35	
310 x	35 x	3	2	1	792.311.35		
350 x	35 x	3	2	1	792.351.35	792.350.35	
400 x	35 x	3	2	1	792.401.35	792.400.35	
410 x	35 x	3	2	1	792.411.35	792.410.35	
430 x	35 x	3	2	1		792.430.35	
450 x	35 x	3	2	1	792.451.35	792.450.35	
500 x	35 x	3	2	1	792.501.35	792.500.35	
510 x	35 x	3	2	1	792.511.35	792.510.35	
520 x	35 x	3	2	1	792.521.35	792.520.35	
530 x	35 x	3	2	1	792.531.35	792.530.35	
550 x	35 x	3	2	1	792.551.35	792.550.35	
600 x	35 x	3	2	1	792.601.35	792.600.35	
610 x	35 x	3	2	1	792.611.35	792.610.35	
630 x	35 x	3	2	1	792.631.35	792.630.35	
650 x	35 x	3	2	1	792.651.35	792.650.35	
710 x	35 x	3	2	1		792.710.35	
810 x	35 x	3	2	1	792.811.35	792.810.35	
820 x	35 x	3	2	1	792.821.35		
1050 x	35 x	3	2	1	792.998.35	792.997.35	

**REMARK:** special dimensions available on request.

The mirror finish on HW knives produces both razor sharp and extremely durable cutting edges.



## TERSA

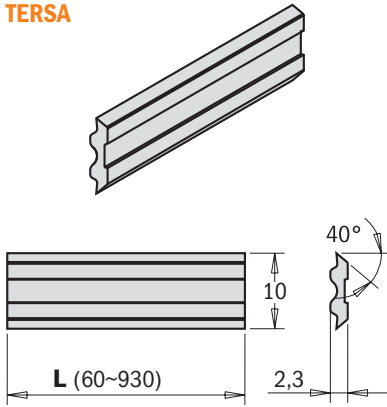

## CENTROSTAR CENTROFIX QUICKFIX

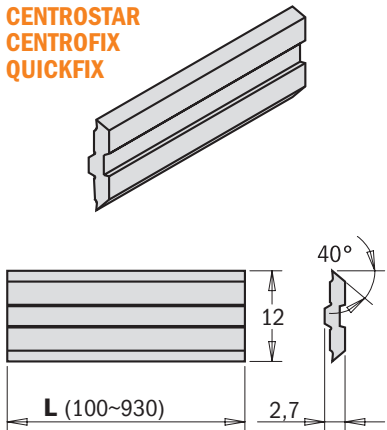

## CENTROLOCK

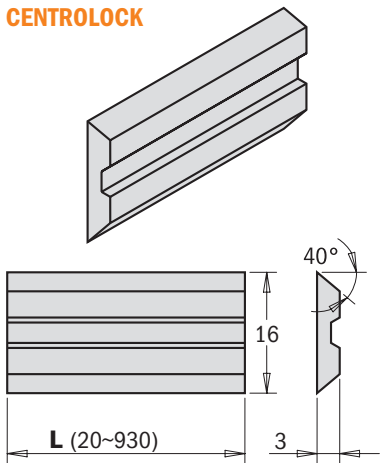

2 KNIVES FOR EACH SET

MATERIAL	GOOD	EXCELLENT
Dry Softwood		●
Wet Softwood		●
Dry Hardwood		●
Wet Hardwood		●
Exotic Hardwood	●	

## 795

TERSA				CENTROSTAR, CENTROFIX, QUICKFIX				CENTROLOCK			
L	H	K	ORDER NO.	L	H	K	ORDER NO.	L	H	K	ORDER NO.
mm	mm	mm		mm	mm	mm		mm	mm	mm	
80 x 10 x 2,3			<b>795.080.10*</b>					20 x 16 x 3			<b>795.020.16*</b>
100 x 10 x 2,3			<b>795.100.10</b>	100 x 12 x 2,7			<b>795.100.12*</b>	80 x 16 x 3			<b>795.080.16*</b>
110 x 10 x 2,3			<b>795.110.10</b>	110 x 12 x 2,7			<b>795.110.12*</b>				
120 x 10 x 2,3			<b>795.120.10</b>	120 x 12 x 2,7			<b>795.120.12</b>				
130 x 10 x 2,3			<b>795.130.10</b>	130 x 12 x 2,7			<b>795.130.12</b>	130 x 16 x 3			<b>795.130.16</b>
150 x 10 x 2,3			<b>795.150.10</b>	150 x 12 x 2,7			<b>795.150.12</b>	150 x 16 x 3			<b>795.150.16</b>
				160 x 12 x 2,7			<b>795.160.12*</b>				
170 x 10 x 2,3			<b>795.170.10</b>	170 x 12 x 2,7			<b>795.170.12*</b>	170 x 16 x 3			<b>795.170.16</b>
180 x 10 x 2,3			<b>795.180.10</b>	180 x 12 x 2,7			<b>795.180.12</b>	180 x 16 x 3			<b>795.180.16</b>
				190 x 12 x 2,7			<b>795.190.12*</b>	190 x 16 x 3			<b>795.190.16</b>
				200 x 12 x 2,7			<b>795.200.12*</b>				
210 x 10 x 2,3			<b>795.210.10</b>					210 x 16 x 3			<b>795.210.16</b>
				220 x 12 x 2,7			<b>795.220.12*</b>				
230 x 10 x 2,3			<b>795.230.10</b>	230 x 12 x 2,7			<b>795.230.12</b>	230 x 16 x 3			<b>795.230.16</b>
								235 x 16 x 3			<b>795.235.16*</b>
				240 x 12 x 2,7			<b>795.240.12</b>	240 x 16 x 3			<b>795.240.16</b>
250 x 10 x 2,3			<b>795.250.10</b>								
260 x 10 x 2,3			<b>795.260.10</b>					260 x 16 x 3			<b>795.260.16</b>
				270 x 12 x 2,7			<b>795.270.12*</b>	270 x 16 x 3			<b>795.270.16</b>
				280 x 12 x 2,7			<b>795.280.12*</b>				
300 x 10 x 2,3			<b>795.300.10</b>								
310 x 10 x 2,3			<b>795.310.10</b>	310 x 12 x 2,7			<b>795.310.12</b>	310 x 16 x 3			<b>795.310.16</b>
330 x 10 x 2,3			<b>795.330.10*</b>								
350 x 10 x 2,3			<b>795.350.10</b>	350 x 12 x 2,7			<b>795.350.12*</b>				
				360 x 12 x 2,7			<b>795.360.12*</b>				
400 x 10 x 2,3			<b>795.400.10</b>	400 x 12 x 2,7			<b>795.400.12</b>				
410 x 10 x 2,3			<b>795.410.10</b>	410 x 12 x 2,7			<b>795.410.12</b>				
420 x 10 x 2,3			<b>795.420.10</b>	420 x 12 x 2,7			<b>795.420.12*</b>				
430 x 10 x 2,3			<b>795.430.10</b>	430 x 12 x 2,7			<b>795.430.12*</b>				
450 x 10 x 2,3			<b>795.450.10</b>	450 x 12 x 2,7			<b>795.450.12*</b>				
500 x 10 x 2,3			<b>795.500.10</b>								
510 x 10 x 2,3			<b>795.510.10</b>	510 x 12 x 2,7			<b>795.510.12</b>				
520 x 10 x 2,3			<b>795.520.10</b>	520 x 12 x 2,7			<b>795.520.12</b>				
530 x 10 x 2,3			<b>795.530.10</b>	530 x 12 x 2,7			<b>795.530.12*</b>				
540 x 10 x 2,3			<b>795.540.10</b>								
610 x 10 x 2,3			<b>795.610.10</b>	610 x 12 x 2,7			<b>795.610.12</b>				
				620 x 12 x 2,7			<b>795.620.12</b>				
630 x 10 x 2,3			<b>795.630.10</b>	630 x 12 x 2,7			<b>795.630.12</b>				
635 x 10 x 2,3			<b>795.635.10</b>								
640 x 10 x 2,3			<b>795.640.10</b>	640 x 12 x 2,7			<b>795.640.12</b>				
650 x 10 x 2,3			<b>795.650.10</b>	650 x 12 x 2,7			<b>795.650.12*</b>				
710 x 10 x 2,3			<b>795.710.10</b>	710 x 12 x 2,7			<b>795.710.12*</b>				
				810 x 12 x 2,7			<b>795.810.12*</b>				
860 x 10 x 2,3			<b>795.860.10*</b>								
910 x 10 x 2,3			<b>795.910.10*</b>								
930 x 10 x 2,3			<b>795.930.10</b>	930 x 12 x 2,7			<b>795.930.12*</b>	930 x 16 x 3			<b>795.930.16</b>

\*While supplies last

### TECHNICAL DETAILS:

HPS® was specially developed for the woodworking industry. The Thyssen-Krupp heat treatment division developed a special heat treatment system in a modern vacuum oven which gives this steel its special attributes and renders it an outstanding alternative to HSS steel. The main advantages are:

- superb wear resistance
- maximum level of toughness
- resistance to softening
- easy to profile
- long lasting tested

Test result: Wood=Oak, Spinadle speed=6000 rpm, feed=24 meter/min  
 = Result HPS® 17500 meters.  
 = Result HSS 10000 meters.

## 790



	L mm	H mm	K mm	A	Z	ORDER NO. K1920	ORDER NO. K2250
	7,5	12	1,5	35°	2	790.075.00	
7,65	12	1,5	35°	2	790.076.00		
9,6	12	1,5	35°	2	790.096.00		
15	12	1,5	35°	2	790.150.00		
19,5	12	1,5	4/35°	2	790.195.12		
20	12	1,5	35°	2	790.200.00	790.200.03	

	L mm	H mm	K mm	A	Z	ORDER NO. K1920	ORDER NO. K2250
	24,7	12	1,5	35°	2	790.250.00	
30	12	1,5	35°	2	790.300.00	790.300.03	
30	12	1,5	45°	2	790.300.20		
40	12	1,5	35°	2	790.400.00	790.400.03	
50	12	1,5	35°	2	790.500.00	790.500.03	
60	12	1,5	35°	2	790.600.00	790.600.03	

	L mm	H mm	K mm	A	Z	ORDER NO. K1920	
	29,5	9	1,5	35°	4	790.295.09	
29,5	12	1,5	35°	4	790.295.12		
39,5	9	1,5	35°	4	790.395.09		
39,5	12	1,5	35°	4	790.395.12		
49,5	9	1,5	35°	4	790.495.09		
49,5	12	1,5	35°	4	790.495.12		

	L mm	H mm	K mm	A	Z	ORDER NO. K1920	
	28,3	12	1,5	35°	4	790.283.12	
48,3	12	1,5	35°	4	790.483.12		

	L mm	H mm	K mm	A	Z	ORDER NO. K1920	ORDER NO. K2250
12	12	1,5	35°	4	790.120.00	790.120.03	
13,6	13,6	2	30°	4	790.136.00		
14	14	1,2	30°	4	790.140.10		
14	14	2	30°	4	790.140.00	790.140.03	
14	14	2	45°	4	790.140.02		

	L mm	H mm	K mm	A	Z	ORDER NO. K1920	
	12	12	1,5	30°	4	790.120.20	
14	14	2	30°		790.140.20		

	L mm	H mm	K mm	R mm	A	Z	ORDER NO. K1920
	15	15	2,5	115	30°	4	790.152.12
15	15	2,5	150	30°	4	790.152.22	

	L mm	H mm	K mm	A	Z	ORDER NO. K1920	
	20	4,1	1,1	35°	4	790.200.01	
30	5,5	1,1	35°	4	790.300.01		
50	5,5	1,1	35°	4	790.500.01		



**790**



	L mm	H mm	K mm	A	Z	ORDER NO.	
	50	9	1,5	35°	4	<b>K1920</b>	<b>790.500.09</b>

	L mm	H mm	K mm	B	A	Z	ORDER NO.
	20	12	1,5	1	35°	2	<b>K1920</b>
	30	12	1,5	2	35°	2	<b>790.201.00</b>
	50	12	1,5	2	35°	2	<b>790.301.00</b>

	L mm	H mm	K mm	Z	ORDER NO.
	18	18	1,95	4	<b>K1920</b>
	18	18	2,45	4	<b>790.181.00</b>

	L mm	H mm	K mm	A	Z	ORDER NO.
	22	19	2	30°	3	<b>K1920</b>
						<b>790.220.02</b>

	L mm	H mm	K mm	A	Z	ORDER NO.
	28	14	2	30°	2	<b>K1920</b>
						<b>790.280.00</b>

	L mm	H mm	K mm	R mm	A	Z	ORDER NO.
	16	22	5	1,5			<b>K1920</b>
	16	22	5	2			<b>790.161.00</b>
	16	22	5	3			<b>790.162.00</b>
	16	22	5		45°		<b>790.163.00</b>
	16	22	5		45°		<b>790.160.00</b>

	L mm	H mm	K mm	R mm	A	Z	ORDER NO.
	19,5	9	1,5	2	35°	2	<b>K1920</b>
	19,5	9	1,5	3	35°	2	<b>790.020.00</b>
	19,5	9	1,5	5	35°	2	<b>790.030.00</b>
	24	12	1,5	6,4	35°	2	<b>790.050.00</b>
	24	12	1,5	8	35°	2	<b>790.064.00</b>
					35°	2	<b>790.080.00</b>

	L mm	H mm	K mm	A	Z	ORDER NO.
	30	12	1,5	35°	1	<b>K1920</b>
						<b>DP</b>
						<b>790.300.60*</b>

\*These knives are supplied in a 2 pc. case. Minimum 2 pieces or multiple of 2 piece order.

MATERIAL	K1920	K2250
Softwood	★★★★★	★★★★★
Hardwood	★★★★★	★★★★★
Chipboard	★★★★★	★★★★★
MDF	★★★★★	★★★★★
HDF	★★★★★	★★★★★
Plastics	★★★	★★★★★
Solid Surface		★★★★★

**TECHNICAL DETAILS:**

**K1920** Hardness (HV10): 1.920 - Transverse rupture strength (N/mm2): 2.600  
New chrome grade for universal cutting applications. Excellent resistance to corrosion, oxidation and mechanical wear. High efficiency, 20% longer lifetime compared to standard grade.

**K2250** Hardness (HV10): 2.250 - Transverse rupture strength (N/mm2): 2.400  
New nano-grain grade for maximum wear resistance. Higher efficiency due to improved tool lifetime. Improved toughness.

All knives are supplied in a 10 pc. case.  
Minimum 10 piece or multiple of 10 piece order.



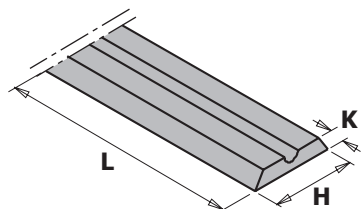

10-PCS. CASE (minimum order)

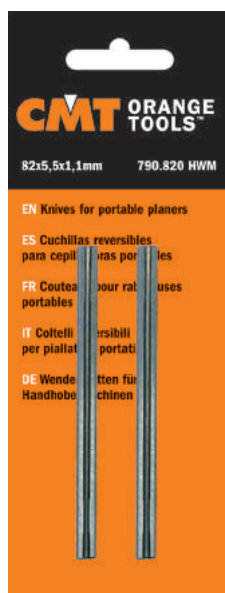

2-PCS. BLISTER CASE  
(790.755/790.780/790.806/790.805/790.820)

## 790

L mm	H mm	K mm	MACHINE	MODEL MACHINE	ORDER NO. 2-pcs. blister case	ORDER NO. 10-pcs. blister case
56	5,5	1,1	Adler			<b>790.560.00</b>
60	5,5	1,1	Wegoma			<b>790.600.01</b>
75,5	5,5	1,1	Aeg	HTH75	<b>790.755</b>	<b>790.755.00</b>
			Black & Decker	DN75, 750SR, 600K		
			Bosch	0590, P400, 1590,1591		
			Festool	REP75		
			Haffner	FH222		
			Holz-Her	2223, 2286, 2320		
			Kress	Jet-Star 6701, 6702		
			Mafell	HU75		
			Metabo	6375		
			Scheer	MH75/3, MH80		
			Skil	98H		
78	5,5	1,1	Virutex		<b>790.780</b>	<b>790.780.00</b>
80,5	5,9	1,2	Elu	MFF40, MFF80, MFF81, MFF81EK, PF161	<b>790.806</b>	<b>790.805.00</b>
80,5	5,5	1,1	Elu Aeg, Bosch Haffner	MFF80	<b>790.805</b>	<b>790.805.01</b>
82	5,5	1,1	Aeg	EH82, EH825, EH822, EH450, EH700, EH82-1, H500, H750, EH700R	<b>790.820</b>	<b>790.820.00</b>
			Black & Decker	DN76		
			Bosch	PHO 100/150, PHO 200/300 4387, PHO 2-82/3-82, Gustav, H00882		
			Casals	CE82		
			DeWalt	DW678, DW678EK, DW680		
			Elu	HH15, HH40, HH40K, HH40EK		
			Fein	HS2151		
			Felisatti	TP282		
			Haffner	FH224		
			Hitachi	F20, F20A, FP20A, P20V, P20SA		
			Holz-Her	2321, 2322		
			Legna	R82, G82		
			Mafell	EHU82, MHU82		
			Makita	1001, 1100, 1125B, 1900B, 1901, 1923B, 1923H, 1923HO		
			Metabo	4382, 8382, 0882, 0883, E0983		
			Peerles	HHB82B		
			Peugeot	RA400, 82RAC, RA82CS, BR82 BRA1-82, BRA3-82, RA1082CA		
			Ryobi	L1323-A		
			Skil	H92, H94, H95, H96, H97 1506, 1510		
			Stayer	980B		
92	5,5	1,2	Aeg	450		<b>790.920.00</b>
			Hitachi	F30A, FU30		
			Ryobi	L120N, L150N, L1205N, L1323		
102	5,5	1,1	Aeg	HB750, EH102, HBE800		<b>790.992.00</b>



2-PCS. BLISTER CASE

L mm	H mm	K mm	MACHINE	MODEL MACHINE	ORDER NO. 2-pcs. HSS	ORDER NO. 2-pcs. HW
82	29	3	Bosch	GH020-82	<b>790.821.50</b>	<b>790.821.10</b>
			B&D	DN710, DB711		
			Makita	1900B, 1923B, 1100, 1901 1125		
			Ryobi	L-1323A, L-282		
<b>new</b>	110	29	3	Makita	1002BA, 1911B	<b>790.110.50</b>

### TECHNICAL DETAILS:

- Order no. ISO: K40
- Hardness (HV10): 1.400
- Transverse rupture strength (N/mm<sup>2</sup>): 2.600

### APPLICATION:

- Softwood ..... Good
- Hardwood ..... Suitable
- Plywood ..... Suitable

# WHAT'S THE SECRET TO FLAWLESS EDGE PROFILES WITH NO REWORK?

**WOOD** MAGAZINE **Best Overall**  
WOOD'S CHOICE 1994  
ROUTER BITS

**CMT Overall Rating 10!**  
**Top Performing Router Bits**



**MULTI-AXIS GRINDING  
 CREATES A 3X LONGER  
 LASTING MIRROR FINISH**

Each cutting edge is precisely sharpened to the micron, in order to produce a cutting angle, which is razor sharp, yet extremely durable.

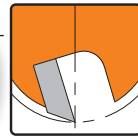

**ANTI-KICKBACK DESIGN**

Controls depth of cut and minimizes the chance of kickback, reducing your risk of injury.



**SINTERHIP**  
**HI-DENSITY  
 INDUSTRIAL CHROME  
 CARBIDE**

**SINTERHIP HI-DENSITY  
 INDUSTRIAL CHROME  
 CARBIDE**

New process called SinterHIP (Hot Isostatic Pressing), helps prevent material failure and increases cutting life.

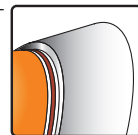

**TRI-METAL BRAZING**

Our Silver-Copper-Silver brazing protects the carbide tip when cutting harder wood or wood composites and reduces the chance of failed welds.



**NON-STICK  
 ORANGE SHIELD  
 COATING®**

Prevents bit from heating up, reduces pitch build-up, protects against corrosion and provides a longer bit life.

























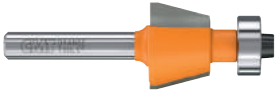























Deluxe packaging

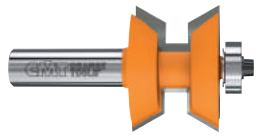





























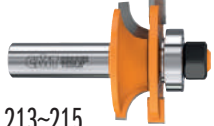
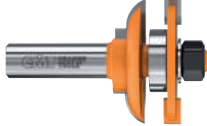

















**SUPERIOR  
 HIGH-STRENGTH STEEL**

We use high-quality, solid bar stock sourced from Switzerland, which provides exceptional resistance to fatigue and abrasion.



<p><b>UP &amp; DOWN CUT SPIRAL</b></p>  <p>146</p>	<p><b>Z1 UPCUT SPIRAL</b></p>  <p>146</p>	<p><b>Z2 UP &amp; DOWN CUT SPIRAL</b></p>  <p>147</p>	<p><b>STRAIGHT WITH CENTER TIP</b></p>  <p>148</p>
<p><b>STRAIGHT</b></p>  <p>149-151</p>	<p><b>STRAIGHT WITH THREADED SHANK</b></p>  <p>152</p>	<p><b>SPIRAL FOR ALUMINIUM</b></p>  <p>153</p>	<p><b>STRAIGHT WITH INSERT KNIVES</b></p>  <p>154-155</p>
<p><b>MORTISING &amp; HINGE</b></p>  <p>156-157</p>	<p><b>PATTERN</b></p>  <p>158</p>	<p><b>PATTERN WITH INSERT KNIVES</b></p>  <p>159</p>	<p><b>WEATHERSEAL</b></p>  <p>160</p>
<p><b>COMBINATION TRIMMER</b></p>  <p>160-161</p>	<p><b>COMBINATION TRIMMER WITH BEARING</b></p>  <p>161</p>	<p><b>FLUSH TRIM</b></p>  <p>162-163</p>	<p><b>SPIRAL FLUSH TRIM</b></p>  <p>164</p>
<p><b>FLUSH TRIM FOR LAMINATE</b></p>  <p>164-165</p>	<p><b>FLUSH TRIM WITH INSERT KNIVES</b></p>  <p>165</p>	<p><b>PATTERN/FLUSH WITH INSERT KNIVES</b></p>  <p>166</p>	<p><b>PATTERN/FLUSH TRIM</b></p>  <p>166</p>
<p><b>PANEL PILOT</b></p>  <p>167</p>	<p><b>RABBETING</b></p>  <p>168-170</p>	<p><b>RABBETING WITH INSERT KNIVES</b></p>  <p>169-170</p>	<p><b>KEYHOLE</b></p>  <p>171</p>
<p><b>T-SLOT</b></p>  <p>171</p>	<p><b>SCREW SLOT</b></p>  <p>172</p>	<p><b>SLOT FOR FLOORING</b></p>  <p>172</p>	<p><b>SLOT CUTTERS &amp; SETS</b></p>  <p>173-176</p>
<p><b>LOCK MITER</b></p>  <p>176-177</p>	<p><b>GLUE JOINT</b></p>  <p>178</p>	<p><b>DRAWER LOCK</b></p>  <p>179</p>	
<p><b>WINDOW SASH</b></p>  <p>180</p>		<p><b>GLASS DOOR SASH</b></p>  <p>181</p>	
<p><b>V-TONGUE &amp; GROOVE</b></p>  <p>183</p>		<p><b>EDGE BANDING</b></p>  <p>183</p>	
<p><b>FINGER JOINT</b></p>  <p>182</p>	<p><b>DOVETAIL</b></p>  <p>184-186</p>	<p><b>60° LETTERING</b></p>  <p>187</p>	<p><b>BOWL &amp; TRAY</b></p>  <p>187</p>
<p><b>V-GROOVING &amp; LASER POINT</b></p>  <p>188-190</p>	<p><b>CHAMFER</b></p>  <p>191-192</p>	<p><b>CHAMFER WITH INSERT KNIVES</b></p>  <p>191</p>	<p><b>ROUND NOSE</b></p>  <p>193</p>

<b>BALL END</b>  194	<b>COVE</b>  195-196	<b>OVOLO &amp; ROUNDROVER</b>  196~199	<b>ROUNDROVER WITH INSERT KNIVES</b>  197
<b>DECORATIVE BEADING</b>  200-201	<b>OGEE &amp; PROFILES</b>  202-203	<b>ADJUSTABLE ROUNDROVER</b>  204	<b>WAINSCOT PANELING</b>  205
<b>CORNER BEADING</b>  205-206	<b>BEAD &amp; BULL NOSE</b>  206	<b>EDGE-FLUTING</b>  207	
<b>MOULDING SYSTEM</b>  207		<b>MOULDING</b>  208~210	<b>FINGER PULL DOOR LIP</b>  210-211
<b>TABLE EDGE &amp; HAND RAIL</b>  212		<b>VERTICAL RAISED PANEL</b>  212	<b>RAISED PANEL</b>  216-217
<b>RAIL &amp; STILE SET</b>  213~215		<b>STILE &amp; PANEL</b>  218	<b>STRIPLOX CUTTER</b>  219
<b>SOLID SURFACE COUNTER-TOP TRIM</b>  219	<b>SOLID SURFACE ROUNDROVER</b>  220-221	<b>SOLID SURFACE BEVEL</b>  222	<b>SOLID SURFACE CUT &amp; PLUG REPAIR SET</b>  223
<b>SOLID SURFACE NO-DRIP</b>  224	<b>SOLID SURFACE WAVY JOINT</b>  224	<b>SOLID SURFACE SINK &amp; TRIM</b>  225-226	<b>ROUTER BIT SETS</b>  227~237
<b>STRAIGHT</b>  239	<b>PATTERN</b>  240	<b>FLUSH TRIM</b>  240	<b>ROUND NOSE</b>  240
<b>V-GROOVE</b>  241	<b>DECORATIVE</b>  241	<b>KEYHOLE</b>  241	<b>DOVETAIL</b>  242
<b>SLOT CUTTER</b>  242	<b>CHAMFER</b>  242	<b>RABBETING</b>  243	<b>COVE</b>  243
<b>OVOLO</b>  243	<b>ROUNDROVER &amp; BEADING</b>  244	<b>OGEE</b>  244	<b>FINGER PULL</b>  245

## BUILDING THE WORLD'S FINEST CUTTING TOOLS

We built our foundations - and our reputation for high quality - on the craftsman-like manufacturing of boring bits and router bits. Times have changed and technology has completely altered the way things are done, and in this regard CMT is no exception. Our facilities have been newly renovated and our equipment today represents the most advanced technology available on the market, but we still make and will continue to make routers and boring bits with all the skill and care that we always have.

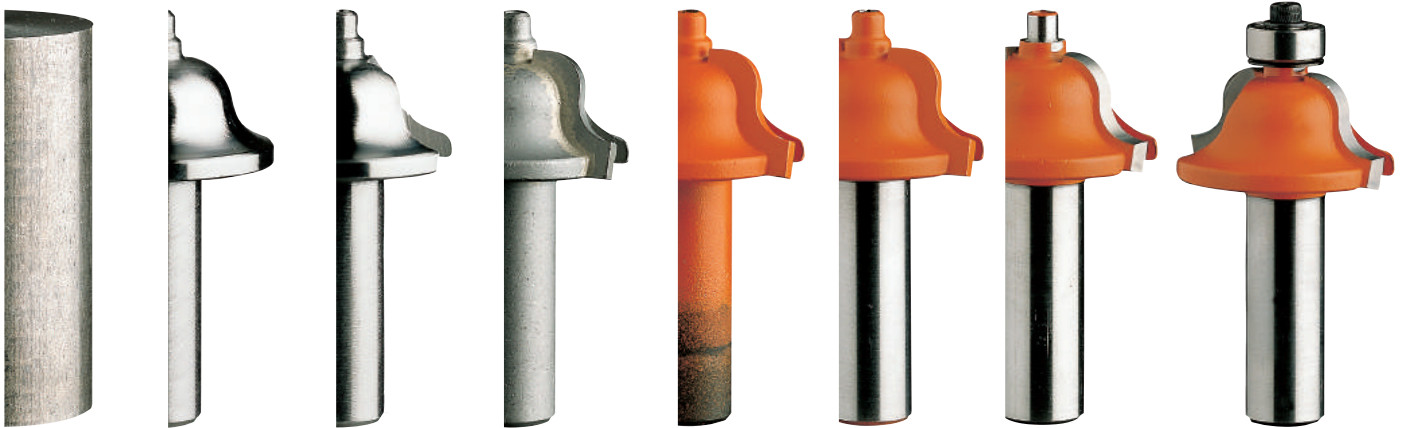

### DESIGN

We engineer each tool with a purpose in mind. Years of developing high performance tools means that many of our top-selling tools are tried and true, the result of continuously perfecting each design, but we don't stop there. New materials, new profiles and new methods of working keep emerging. At CMT, we want to stay on the cutting edge of what's new in the industry so our technical department constantly evaluates current market developments and, by using state of the art software and years of experience, designs tools that are worthy of the CMT brand.

### MATERIALS

Essentially, the main components of a router bit are just two: steel and carbide. If either of these is less than the best, the tool we make will show it. We've researched steel and carbide since the beginning, and found exactly what we were looking for:

**Superior Steel.** All our steel comes from right above the border, in Switzerland, where they use an exclusive hot drawing process to forge the solid bar stock we use to manufacture our router bit shanks and bodies. The result is steel that is superior in strength and exceptionally resistant to fatigue and abrasion.

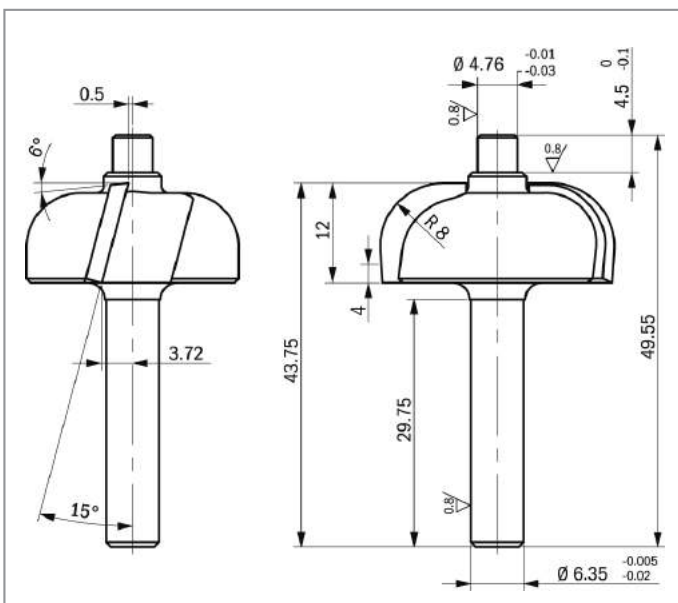



**High-Grade Tungsten Carbide.** If steel is what gives our tools strength, carbide is what gives them intelligence. The capacity of the carbide tip to cut precisely and to last a long time is critical for the performance of any tool, so at CMT we use only premium micrograin carbide from Luxembourg to make the tips for our router bits.

## MANUFACTURING

**Turning, Milling and Cutting.** Our biggest investment in recent years has been in upgrading production. Today, all machinery at CMT is fully automated. CNC machines run by specially trained operators who make sure that the shanks and bodies of our router bits and boring bits are accurate and perfectly balanced.



**Heat Forged Steel Bodies for Large Diameter Bits.** No router bits are exactly the same, sometimes not even in the way they are made. Certain bits require a few more steps than others, like heat forging the steel of larger diameter bits before turning it down into precise bit bodies. This extra step produces a radial grain orientation which gives large diameter bits extra strength and durability.

**Brazing.** We have pioneered the art of brazing. Not only does our unique custom-designed computerized brazing equipment help eliminate the inconsistencies found in old fashioned hand brazing, but our silver-copper-silver brazing 'sandwich' provides a tight bond between the steel and the carbide, with a shock absorbing effect to protect the carbide tips when cutting harder woods.

**Specially Formulated Carbide for Specific Applications.** You have to cut every kind material, so we make sure that our carbide tips can handle each individual job. This means specially formulating the carbide of each tool so that the compositions vary from being super hard (for tough cutting jobs like laminates) to being less hard (to absorb the impact when cutting large profiles) and everything in between.

**Grinding and Sharpening.** The final step in the production process is no different from the rest: sharpening and grinding are done to extreme precision on multi-axis CNC machines. Each bevel and angle is ground or sharpened to the micron, to produce a cutting edge that is both razor



680°C in seconds - and the brazing is complete.

sharp yet extremely durable.

## QUALITY CONTROL

In even the most carefully done task, there's always room for error. However at CMT, we take measures to prevent even this. We always manually check the quality of our tools at each step of the manufacturing process, and we still make test cuts with rail & stile bits to make sure the cut fits. However, now we also use a fully automatic measuring process that measures every dimension of the tool without actually coming into contact with it, to make sure that the tool measurements are accurate and that the profiles conform precisely to technical specifications. We also use this system to gauge the wear and tear on the CNC machines.



CMT's fully automatic measuring system.

## CUTTING EDGE TYPE

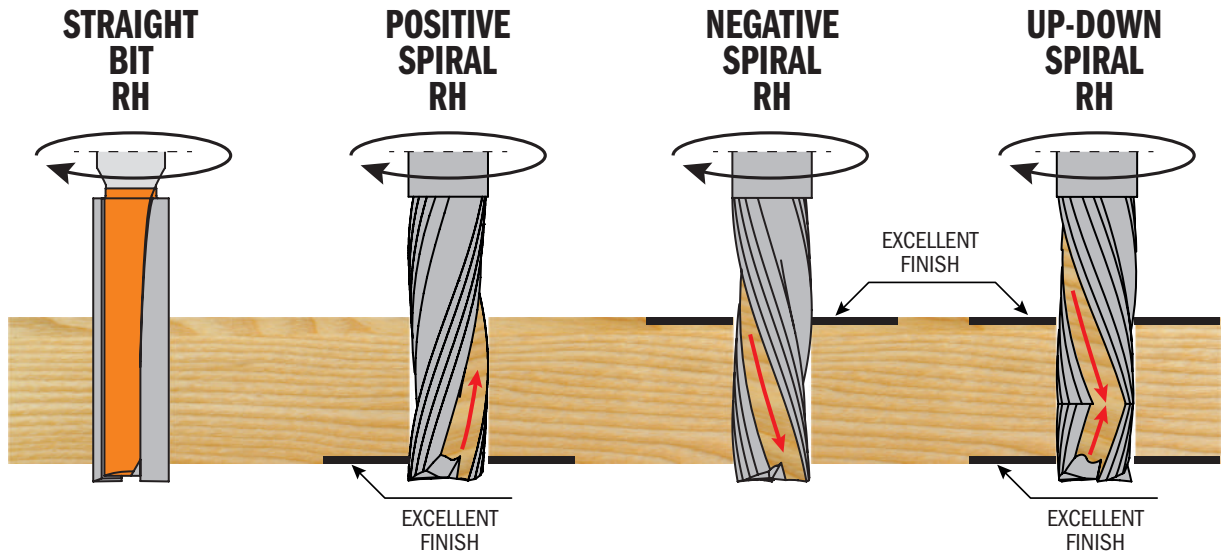

## RECOMMENDED PLUNGING METHOD

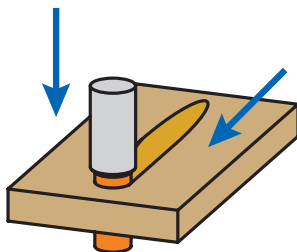

**RAMP PLUNGING**

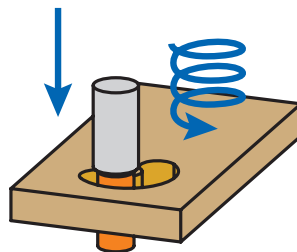

**SPIRAL PLUNGING**

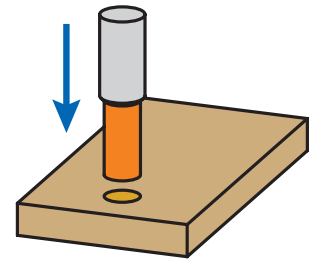

**AXIAL PLUNGING**

Router bits with mainly negative cutting shear angles, negative spiral, and router bits without plunging cutter are not suitable for axial plunging!

These methods are recommended for sizing and grooving tools.

## PROBLEM SOLVING

### PROBLEM

Bad finishing
Cutting edge wear
Cutting edge burns
Cutting edge debris
Vibrations
Cutter breakage

### SOLUTIONS

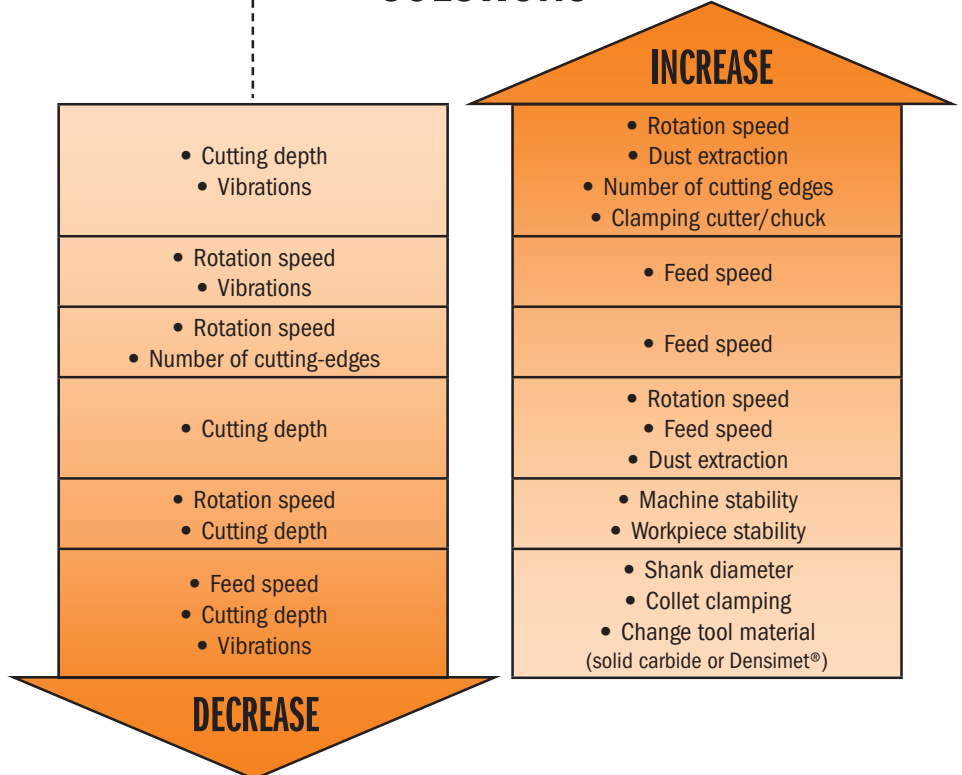





# X-TREME COATING

## THE ULTIMATE TECHNOLOGY FOR INDUSTRIAL CNC TOOLS

DLCS is a modified diamond-like carbon coating with enhanced load bearing capacity. A hard, durable metal-based layer (chromium nitride) provides a higher hardness surface and increases the resilience of the superposed, tribologically effective carbon coating. Coating prevents high heats which is detrimental to cutting tool performance and will remain fully effective after use.

<p><b>Extreme Coating Hardness</b> <b>&gt;HV 2.500</b></p> <p>Offers impressive hardness on cutting areas of the tool and superb protection against abrasive wear and stress resistance.</p>	<p><b>Minimal coating thickness</b> <b>µm 2-4</b></p> <p>The minimal micron coating guaranteed perfect sharpen edges for high cutting quality.</p>	<p><b>The lowest coefficient of friction</b> <b>0,1-0,2</b></p> <p>Very good running-in and low friction losses. Reduction of sticking. Ideal for high speeds in Nesting applications.</p>	<p><b>High Working Temperature</b></p> <p>Less overheating! The coating guarantees working temperature up to 400° preserving the cutting edges from wear.</p>
--	--	--	---

## BENEFITS



**3X**  
LONGER LIFE  
THAN UNCOATED

**DLCS CHROME COATING**  
provides 3 times longer life  
than uncoated tools!



**Test performed in U.S. with 1/2" solid carbide compression spiral bit**

**MACHINE:** Felder Profit H10 Nested Base/Overhead CNC Router

**WORKING PARAMETERS:** RPM = 18,000 - Feed = 20 mts/minute

**MATERIAL:** 19mm Melamine Chipboard

**APPLICATION:** Nesting Full Dimensioning

**PERFORMANCE:** DLCS coated bit cut 165 melamine panels  
Uncoated bit cut 56 melamine panels

Felder Profit H10

DLCS coated bit

Melamine Chipboard

Cut quality after 165 panels





# Solid Carbide Spiral Bits

Due to their spiral cutting edge which stays in continuous contact with the workpiece, these bits give a smooth, chatter-free cutting action, unlike conventional bits which have intermittent contact with the workpiece. Unsurpassed for cleaner cuts in ordinary or difficult materials, softwood, hardwood, plywood, composites etc. This new range of spiral bits with 6 - 8 - 12mm and 6,35 - 12,7mm shanks allow them to be used with a CNC router and hand-routers.

**Test check yourself the extraordinary quality-price ratio of these bits!**

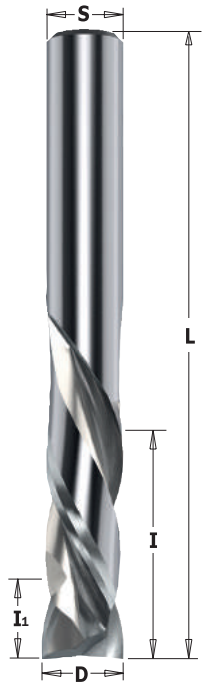

## 190 Upcut & Downcut Spiral

D mm	I mm	I <sub>1</sub> Pos. mm	L mm	Z	ORDER NO. S=Ø6,35mm	ORDER NO. S=Ø8mm	ORDER NO. S=Ø9,52mm	ORDER NO. S=Ø10mm	ORDER NO. S=Ø12mm	ORDER NO. S=Ø12,7mm
<b>new</b> 6,35	22,2	7	63,5	2+2	10	<b>190.008.11</b>				
8	32	7	80	2+2	10		<b>190.080.11</b>			
9,52	28,6	7	76,2	2+2	10			<b>190.504.11</b>		
10	32	7	80	2+2	10				<b>190.100.11</b>	
10	42	7	90	2+2	10				<b>190.101.11</b>	
12	42	7	90	2+2	10					<b>190.120.11</b>
12	52	7	100	2+2	10					<b>190.121.11</b>
12,7	25,4	12	76,2	2+2	10					<b>190.505.11</b>
12,7	28,6	12	76,2	2+2	10					<b>190.506.11</b>
12,7	34,9	12	88,9	2+2	10					<b>190.507.11</b>
12,7	41,3	12	101,6	2+2	10					<b>190.508.11</b>
<b>Up &amp; Downcut Mortising Bits</b>										
9,52	22,2	4,8	76,2	2+2	10			<b>190.513.11</b>		
9,52	25,4	5,2	76,2	3+3	10			<b>190.813.11</b>		
12	25,4	5,2	83	3+3	10				<b>190.320.11</b>	
12,7	22,2	5,2	76,2	2+2	10					<b>190.515.11</b>
12,7	34,9	5,2	88,9	2+2	10					<b>190.517.11</b>
<b>new</b> 12,7	28,5	6	76,2	3+3	10					<b>190.815.11</b>



## 190.41 Upcut & Downcut Spiral - DLCS Chrome Coating Long Life



D mm	I mm	I <sub>1</sub> Pos. mm	L mm	Z	ORDER NO. S=Ø9,52mm	ORDER NO. S=Ø12mm	ORDER NO. S=Ø12,7mm
9,52	28,6	7	76,2	2+2	10	<b>190.504.41</b>	
12	42	7	90	2+2	10		<b>190.120.41</b>
12	52	7	100	2+2	10		<b>190.121.41</b>
12,7	25,4	12	76,2	2+2	10		<b>190.505.41</b>
12,7	28,6	12	76,2	2+2	10		<b>190.506.41</b>
12,7	34,9	12	88,9	2+2	10		<b>190.507.41</b>
12,7	41,3	12	101,6	2+2	10		<b>190.508.41</b>
<b>Up &amp; Downcut Mortising Bits</b>							
9,52	22,2	4,8	76,2	2+2	10	<b>190.513.41</b>	
9,52	25,4	5,2	76,2	3+3	10	<b>190.813.41</b>	
12	25,4	5,2	83	3+3	10		<b>190.320.41</b>
12,7	22,2	5,2	76,2	2+2	10		<b>190.515.41</b>
12,7	34,9	5,2	88,9	2+2	10		<b>190.517.41</b>
12,7	28,5	6	76,2	3+3	10		<b>190.815.41</b>

Excellent finish

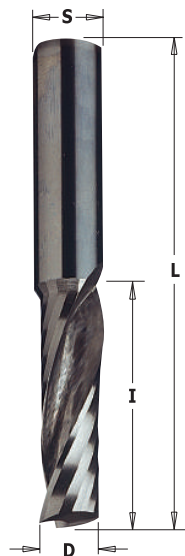

## 198 Upcut

D mm	I mm	L mm	ORDER NO. S=Ø6mm	ORDER NO. S=Ø6,35mm	ORDER NO. S=Ø8mm	ORDER NO. S=Ø12mm
3,18	12,7	50,8	10	<b>198.001.11</b>		
4,76	15,87	50,8	10	<b>198.005.11</b>		
6	22	60	10	<b>198.060.11</b>		
6,35	19,05	50,8	10		<b>198.007.11</b>	
6,35	25,4	63,5	10		<b>198.008.11</b>	
8	22	70	10			<b>198.080.11</b>
8	32	80	10			<b>198.081.11</b>
12	32	83	10			<b>198.120.11</b>



Excellent finish

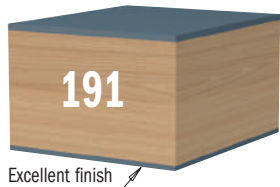
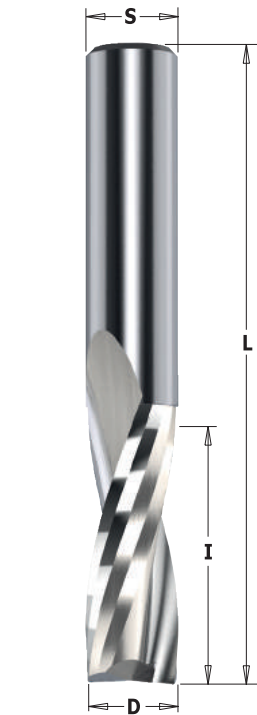

## 191 Upcut Spiral



D mm	I mm	L mm		ORDER NO. S=Ø6mm	ORDER NO. S=Ø6,35mm	ORDER NO. S=Ø8mm	ORDER NO. S=Ø12mm	ORDER NO. S=Ø12,7mm
3	12	60	10	<b>191.630.11</b>		<b>191.830.11</b>		
3,18	12,7	50,8	10		<b>191.001.11</b>			
3,5	12	60	10	<b>191.635.11</b>				
3,97	12,7	50,8	10		<b>191.003.11</b>			
4	15	60	10	<b>191.640.11</b>		<b>191.840.11</b>		
4,76	19,05	50,8	10		<b>191.005.11</b>			
5	17	60	10	<b>191.650.11</b>		<b>191.850.11</b>		
6	27	70	10	<b>191.060.11</b>		<b>191.860.11</b>		
6,35	19,05	50,8	10		<b>191.007.11</b>			
6,35	25,4	63,5	10		<b>191.008.11</b>			
7	32	80	10			<b>191.870.11</b>		
7,94	25,4	76,2	10					<b>191.501.11</b>
8	22	70	10			<b>191.080.11</b>		
8	32	80	10			<b>191.081.11</b>		
8	42	90	10			<b>191.082.11</b>		
9	32	83	10				<b>191.890.11</b>	
9,53	31,75	82,5	10					<b>191.503.11</b>
10	32	80	10			<b>191.800.11</b>		
10	32	83	10				<b>191.900.11</b>	
10	42	90	10				<b>191.901.11</b>	
12	35	83	10			<b>191.820.11</b>	<b>191.120.11</b>	
12	42	90	10				<b>191.121.11</b>	
12	52	100	10				<b>191.122.11</b>	
12,7	31,75	76,2	10					<b>191.505.11</b>
12,7	38,1	88,9	10					<b>191.506.11</b>
12,7	50,8	101,6	10					<b>191.507.11</b>

10 pc. masterpack

6,35 25,4 63,5 **191.008.11-X10**

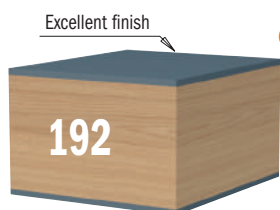

## 192 Downcut Spiral



D mm	I mm	L mm		ORDER NO. S=Ø6mm	ORDER NO. S=Ø6,35mm	ORDER NO. S=Ø8mm	ORDER NO. S=Ø12mm	ORDER NO. S=Ø12,7mm
3	12	60	10	<b>192.630.11</b>		<b>192.830.11</b>		
3,18	12,7	50,8	10		<b>192.001.11</b>			
3,97	12,7	50,8	10		<b>192.003.11</b>			
4	15	60	10	<b>192.640.11</b>		<b>192.840.11</b>		
4,76	19,05	50,8	10		<b>192.005.11</b>			
5	17	60	10	<b>192.650.11</b>		<b>192.850.11</b>		
6	27	70	10	<b>192.060.11</b>		<b>192.860.11</b>		
6,35	19,05	50,8	10		<b>192.007.11</b>			
6,35	25,4	63,5	10		<b>192.008.11</b>			
7,94	25,4	76,2	10					<b>192.501.11</b>
8	22	70	10			<b>192.080.11</b>		
8	32	80	10			<b>192.081.11</b>		
8	42	90	10			<b>192.082.11</b>		
9,53	31,75	82,5	10					<b>192.503.11</b>
10	32	80	10			<b>192.800.11</b>		
10	32	83	10				<b>192.900.11</b>	
12	35	83	10			<b>192.820.11</b>	<b>192.120.11</b>	
12,7	31,75	76,2	10					<b>192.505.11</b>
12,7	38,1	88,9	10					<b>192.506.11</b>
12,7	50,8	101,6	10					<b>192.507.11</b>

10 pc. masterpack

8 32 80 **192.081.11-X10**

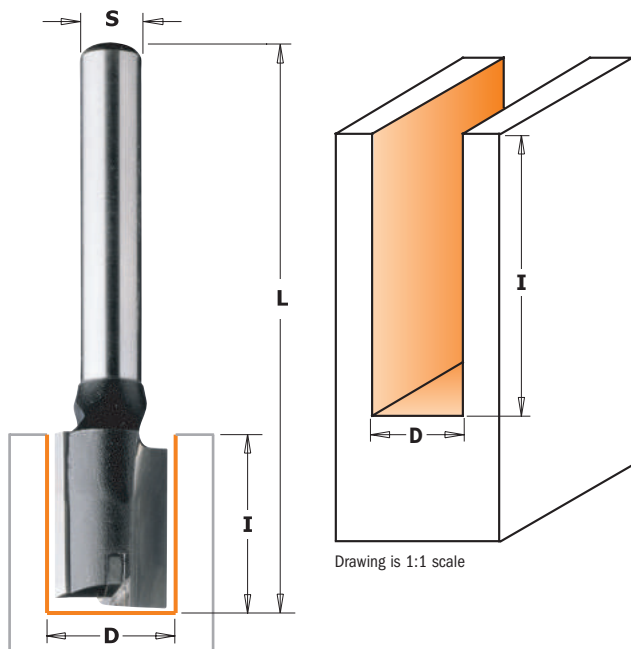

## 174-177



These industrial straight bits are made from stainless steel specifically created to withstand rigorous work on router machines and CNC routers.

The cutting edge allows you to execute any kind of plunge drilling and trimming jobs on soft or hardwood, wood composites and plastic or laminated materials.

**APPLICATION:** used for drilling, grooving or jointing solid wood and wood composites. Can be used on machining centres, CNC routers and hand-held routers equipped with chucks or adapters.

### Plunge Centre Tip

This particular kind of cutting edge guarantees long-lasting performance during plunging operations.

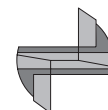

## 177

D mm	I mm	L mm		ORDER NO. S=∅12mm
10	35	90	10	<b>177.100.11</b>
12	35	90	10	<b>177.120.11</b>
12	50	100	10	<b>177.121.11</b>
14	35	90	10	<b>177.140.11</b>
16	35	90	10	<b>177.160.11</b>
16	60	110	10	<b>177.161.11</b>
18	35	90	10	<b>177.180.11</b>
18	60	110	10	<b>177.181.11</b>
20	35	90	10	<b>177.200.11</b>
22	35	90	10	<b>177.220.11</b>
24	35	90	10	<b>177.240.11</b>
25	35	90	10	<b>177.250.11</b>
26	35	90	10	<b>177.260.11</b>
28	35	90	10	<b>177.280.11</b>
30	35	90	10	<b>177.300.11</b>
35	35	90	10	<b>177.350.11</b>

## 174

• HWM

D mm	I mm	L mm		ORDER NO. S=∅8mm
• 3	10	55	10	<b>174.030.11</b>
• 4	10	55	10	<b>174.040.11</b>
• 5	12	55	10	<b>174.050.11</b>
• 6	14	55	10	<b>174.060.11</b>
• 7	20	55	10	<b>174.070.11</b>
8	20	55	10	<b>174.080.11</b>
8	30	70	10	<b>174.081.11</b>
8	40	90	10	<b>174.082.11</b>
9	20	55	10	<b>174.090.11</b>
10	20	60	10	<b>174.100.11</b>
10	30	70	10	<b>174.102.11</b>
10	40	90	10	<b>174.101.11</b>
11	20	60	10	<b>174.110.11</b>
12	20	60	10	<b>174.120.11</b>
12	30	70	10	<b>174.122.11</b>
12	40	90	10	<b>174.121.11</b>
13	20	60	10	<b>174.130.11</b>
14	20	60	10	<b>174.140.11</b>
14	30	70	10	<b>174.142.11</b>
14	40	90	10	<b>174.141.11</b>
15	20	60	10	<b>174.150.11</b>
16	20	70	10	<b>174.160.11</b>
16	30	70	10	<b>174.162.11</b>
16	40	90	10	<b>174.161.11</b>
18	20	70	10	<b>174.180.11</b>
18	30	70	10	<b>174.181.11</b>
18	40	80	10	<b>174.182.11</b>
19	20	70	10	<b>174.190.11</b>
20	20	70	10	<b>174.200.11</b>
20	30	70	10	<b>174.201.11</b>
20	40	90	10	<b>174.202.11</b>
22	20	70	10	<b>174.220.11</b>
22	30	70	10	<b>174.221.11</b>
22	40	90	10	<b>174.222.11</b>
23,5	20	70	10	<b>174.235.11</b>
24	20	70	10	<b>174.240.11</b>
24	30	70	10	<b>174.241.11</b>
24	40	90	10	<b>174.242.11</b>
25	20	70	10	<b>174.250.11</b>
26	20	70	10	<b>174.260.11</b>
26	30	70	10	<b>174.261.11</b>
28	20	70	10	<b>174.280.11</b>
28	30	70	10	<b>174.281.11</b>
29	20	70	10	<b>174.290.11</b>
30	20	70	10	<b>174.300.11</b>



HWM HW Z2 RH

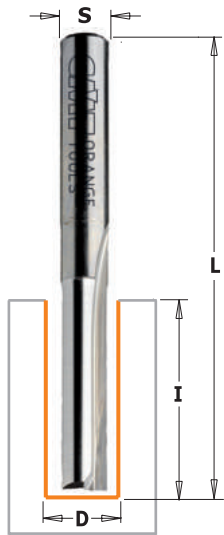

## 7/8/912

**SAFETY PRECAUTIONS:** never use damaged or worn bits. Always work at the recommended proper feed rate without forcing the bit. Pay particular attention when making the initial cut with a small diameter bit. For best results when working with small diameter bits, make the cut in more than one pass.

The sharpened cutting edge on 9mm diameter bits or larger are perfect for short plunging operations.

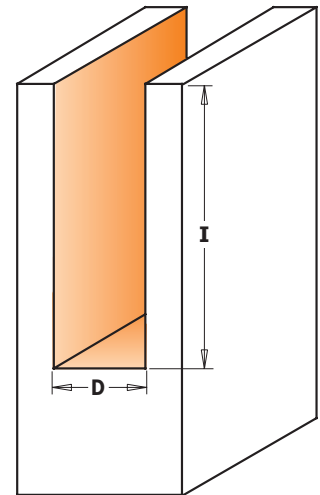
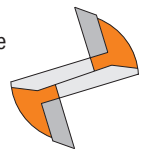

Drawing is 1:1 scale



Masterpack

• HWM

D mm	I mm	L mm		ORDER NO. S=Ø6mm	ORDER NO. S=Ø6,35mm	ORDER NO. S=Ø8mm	ORDER NO. S=Ø12mm	ORDER NO. S=Ø12,7mm
• 3	11	60	10	<b>712.030.11</b>				
• 3,2	12,7	50,8	10		<b>812.032.11</b>			
• 4	12	60	10	<b>712.040.11</b>				
• 5	18	60	10	<b>712.050.11</b>				
• 6	25,4	60	10	<b>712.060.11</b>	<b>812.060.11</b>	<b>912.060.11</b>		
• 6,35	25,4	60	10		<b>812.064.11</b>			
• 8	31,7	60	10	<b>712.080.11</b>	<b>812.080.11</b>	<b>912.080.11</b>		
• 8	31,7	75	10				<b>912.580.11</b>	
9	31,7	75	10				<b>912.590.11</b>	
9,5	31,7	63,5	10		<b>812.095.11</b>			
9,5	31,7	73	10					<b>812.595.11</b>
10	31,7	60	10	<b>712.100.11</b>	<b>812.100.11</b>	<b>912.100.11</b>		
10	31,7	70	10					<b>812.600.11</b>
10	31,7	74	10				<b>912.600.11</b>	
11,1	31,7	82,5	10					<b>812.611.11</b>
12	31,7	60	10	<b>712.120.11</b>	<b>812.120.11</b>	<b>912.120.11</b>		
12	31,7	70	10					<b>812.620.11</b>
12	38,1	95	10				<b>912.621.11</b>	<b>812.621.11</b>
12	50,8	108	10				<b>912.622.11</b>	
12*	70	110	10				<b>912.623.11</b>	
12,7	31,7	70	10		<b>812.127.11</b>	<b>912.127.11</b>		
12,7	38,1	95	10					<b>812.627.11</b>
12,7	50,8	108	10					<b>812.628.11</b>
12,7	63,5	111	10					<b>812.629.11</b>
14	31,7	60	10	<b>712.140.11</b>	<b>812.140.11</b>	<b>912.140.11</b>		
14	31,7	70	10				<b>912.640.11</b>	
15	31,7	66	10	<b>712.150.11</b>	<b>812.150.11</b>	<b>912.150.11</b>		
15	31,7	70	10				<b>912.650.11</b>	
15,8	31,7	70	10		<b>812.158.11</b>			
16	31,7	66	10	<b>712.160.11</b>	<b>812.160.11</b>	<b>912.160.11</b>		
16	31,7	70	10				<b>912.660.11</b>	<b>812.660.11</b>
18	38,1	80	10				<b>912.681.11</b>	
19	38,1	82,5	10				<b>912.690.11</b>	<b>812.690.11</b>
19	50,8	92	10				<b>912.691.11</b>	<b>812.691.11</b>
20	38,1	80	10				<b>912.701.11</b>	
22	38,1	80	10				<b>912.721.11</b>	
<b>10 pc. masterpack</b>								
6,35	25,4	60						<b>812.064.11-X10</b>
12,7	50,8	108						<b>812.628.11-X10</b>

\* Z2+1 Warning. Long cutting edges. Carefully make several shallow passes to prevent damaging the tool. The warranty does not cover improper use of the tool.



## 7/8/911

If you are looking to get the most out of your time and money through more efficient production, but want nothing less than a beautiful clean edge on your finished piece, then you definitely must include CMT straight bits in your collection. These razor-sharp, double-faced cutters perfectly synthesize the characteristics and advantages that define quality CMT products. Made of special Fatigue Proof™ steel and micrograin carbide, our straight bits can withstand even the heaviest work load and still give you a smooth, precise cut every time. You also get exceptional chip ejection to allow cleaner and more constant cutting.

The surface of all CMT bits is protected with our trademark orange non-stick PTFE coating to help keep the bit from collecting resin, pitch and other residue. Every bit is subject to strict quality tests to guarantee perfect cutting tolerance, balance and concentricity. CMT bits allow production on an industrial scale using a variety of plywood, composites and natural woods. CMT produces 91 types of straight bits in a wide range of diameters so you can find exactly what you want.



The sharpened cutting edge is perfect for short plunging operations.

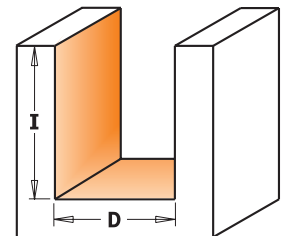

Drawing is 1:1 scale



Biscuit joint using bit #7/8/911.040.11

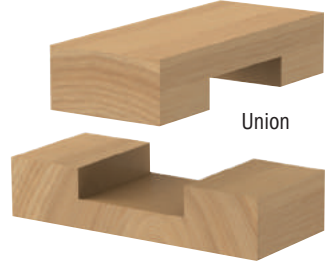

Union

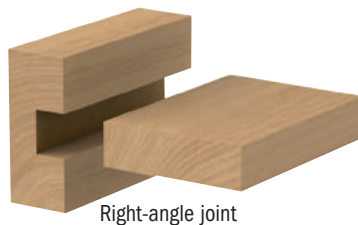

Right-angle joint

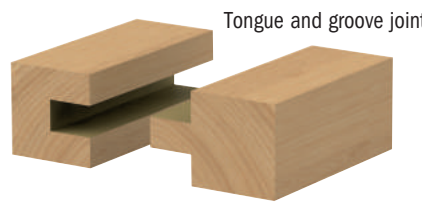

Tongue and groove joint

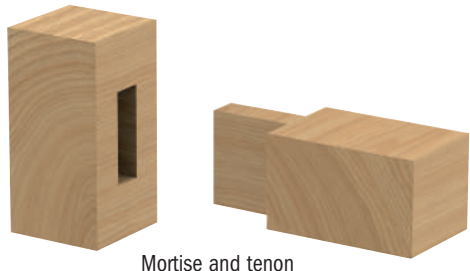

Mortise and tenon



Rabbet

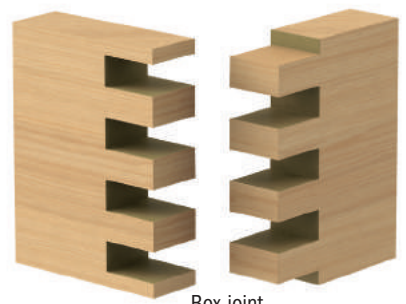

Box joint

## Plywood Groove Set



## 811



These groove bits are specifically designed to rout grooves and dadoes for joints in plywood. This means they match the true thickness of the material, producing tight, accurate joints. Use our 18.2mm bit for 19mm plywood, 12.3mm bit for 12.7mm plywood and our 6mm bit for 6.35mm plywood. No gaps. No sloppy joints. No worries! These money-saving 3-bit sets are available with 12.7mm or 6.35mm shanks.

### Example shown in 12,7mm thick plywood

This joint is made with the CMT 12,3mm straight bit for 12,7mm plywood. Notice the precise fit - no gaps.

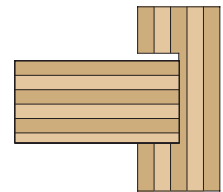
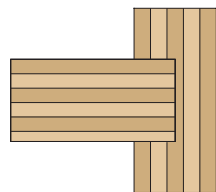

This joint is made with a regular 12,7mm straight bit for 12,7mm plywood. Notice the extra space and ill fitting joint.

DESCRIPTION		ORDER NO. S=Ø6,35mm	ORDER NO. S=Ø12,7mm
Plywood Groove Set (Ø6 - Ø12,3 - Ø18,2mm)	5	<b>811.001.11</b>	<b>811.501.11</b>

# Straight Bits, Short Series



D mm	I mm	L mm		ORDER NO. S=Ø6mm	ORDER NO. S=Ø6,35mm	ORDER NO. S=Ø8mm	ORDER NO. S=Ø12mm	ORDER NO. S=Ø12,7mm
• 2*	4	45	10	<b>711.020.11</b>	<b>811.020.11</b>			
• 3	8	45	10	<b>711.030.11</b>	<b>811.030.11</b>			
• 3	8	50	10			<b>911.030.11</b>		
• 3	8	58,3	10				<b>911.530.11</b>	
• 3,2	9,5	45	10		<b>811.032.11</b>			
• 4	10	58,3	10				<b>911.540.11</b>	
• 4	10	45	10	<b>711.040.11</b>	<b>811.040.11</b>			
• 4	10	50	10			<b>911.040.11</b>		
• 4,75	12,7	50,8	10		<b>811.047.11</b>			
• 5	12	50	10	<b>711.050.11</b>	<b>811.050.11</b>	<b>911.050.11</b>		
• 5	12	58,3	10				<b>911.550.11</b>	
• 6	16	50	10	<b>711.060.11</b>	<b>811.060.11</b>	<b>911.060.11</b>		
• 6	19	63,5	10				<b>911.560.11</b>	<b>811.560.11</b>
• 6,35	19	50,8	10		<b>811.064.11</b>			
• 6,35	19	57,2	10		<b>811.065.11</b>			
• 6,35	19	63,5	10					<b>811.564.11</b>
• 7	18	49	10	<b>711.070.11</b>	<b>811.070.11</b>	<b>911.070.11</b>		
• 7	18	63,5	10				<b>911.570.11</b>	
• 7,6	20	50	10			<b>911.076.11</b>		
• 8	20	50	10	<b>711.080.11</b>	<b>811.080.11</b>	<b>911.080.11</b>		
• 8	25,4	70	10		<b>811.081.11</b>			
• 8	25,4	70	10					<b>811.581.11</b>
9	20	48	10	<b>711.090.11</b>		<b>911.090.11</b>		
9,5	19	50,8	10		<b>811.095.11</b>			
9,5	25,4	63,5	10		<b>811.096.11</b>			
9,5	25,4	66,7	10					<b>811.595.11</b>
10	20	48	10	<b>711.100.11</b>	<b>811.100.11</b>	<b>911.100.11</b>		
10	25,4	63,5	10					<b>811.600.11</b>
11	20	48	10	<b>711.110.11</b>		<b>911.110.11</b>		
12	20	50	10	<b>711.120.11</b>	<b>811.120.11</b>	<b>911.120.11</b>		
12	25,4	63,5	10				<b>911.620.11</b>	<b>811.620.11</b>
12,3	25,4	57,2	10		<b>811.123.11</b>			
12,3	25,4	63,5	10					<b>811.623.11</b>
12,7	19	57,2	10		<b>811.127.11</b>			
12,7	25,4	66,7	10					<b>811.627.11</b>
12,7	31,7	82,5	10					<b>811.628.11</b>
13	20	57	10	<b>711.130.11</b>		<b>911.130.11</b>		
14	20	50	10	<b>711.140.11</b>	<b>811.140.11</b>	<b>911.140.11</b>		
14,2	14,2	57,2	10		<b>811.142.11</b>			
15	20	57,2	10	<b>711.150.11</b>	<b>811.150.11</b>	<b>911.150.11</b>		
15,8	19	66,7	10		<b>811.158.11</b>			
15,8	25,4	63,5	10					<b>811.660.11</b>
16	20	57,2	10	<b>711.160.11</b>	<b>811.160.11</b>	<b>911.160.11</b>		
16	25,4	63,5	10					<b>811.661.11</b>
17	20	50	10	<b>711.170.11</b>				
18	20	50	10	<b>711.180.11</b>	<b>811.180.11</b>	<b>911.180.11</b>		
18,2	25,4	57,2	10		<b>811.182.11</b>			
18,2	25,4	63,5	10					<b>811.682.11</b>
19	20	57,2	10	<b>711.190.11</b>	<b>811.191.11</b>	<b>911.190.11</b>		
19	25,4	63,5	10					<b>811.690.11</b>
19,85	25,4	59	10					<b>811.700.11</b>
20	20	50	10	<b>711.200.11</b>	<b>811.200.11</b>	<b>911.200.11</b>		
22	20	57,2	10	<b>711.220.11</b>	<b>811.220.11</b>	<b>911.220.11</b>		
24	20	50	10	<b>711.240.11</b>		<b>911.240.11</b>		
25	20	50	10	<b>711.250.11</b>		<b>911.250.11</b>		
25,4	19	50,8	10		<b>811.254.11</b>			
25,4	31,7	76,2	10					<b>811.754.11</b>
28,5	31,7	76,2	10					<b>811.785.11</b>

**10 pc. masterpack**

9,5	25,4	63,5						<b>811.096.11-X10</b>
-----	------	------	--	--	--	--	--	-----------------------

• HWM  
\* Z1





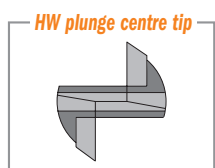
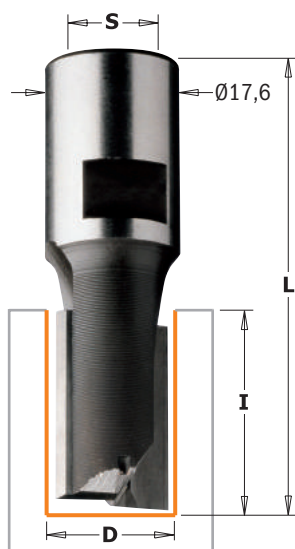

**TECHNICAL DETAILS:**

- Super strength steel
- 2 HW alternating precision ground cutting edges [Z2+1]

**APPLICATION:** ideal for cutting openings for electrical boxes and similar operations in solid wood, wood composites, plastics and laminates. Can be used on machining centres, CNC routers and hand-held routers equipped with chucks or adapters.

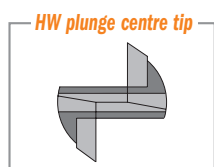

## 170-171-180-181



D mm	I mm	L mm		ORDER NO. S=M12x1
6	18	60	1	170.060.11
8	23	60	1	170.080.11
10	23	60	1	170.100.11
11	23	60	1	170.110.11
12	23	60	1	170.120.11
14	23	60	1	170.140.11
15	25	60	1	170.150.11
16	25	60	1	170.160.11
18	25	60	1	170.180.11
20	25	60	1	170.200.11
22	25	60	1	170.220.11
24	25	60	1	170.240.11
25	25	60	1	170.250.11
26	25	60	1	170.260.11
28	25	60	1	170.280.11
30	25	60	1	170.300.11
35	25	60	1	170.350.11
8	35	67	1	171.080.11
10	35	67	1	171.100.11
12	35	67	1	171.120.11
14	35	67	1	171.140.11
16	35	67	1	171.160.11
18	35	67	1	171.180.11
20	35	67	1	171.200.11
22	35	67	1	171.220.11
12	45	77	1	180.120.11
16	45	77	1	180.160.11
18	45	77	1	180.180.11
20	45	77	1	180.200.11
16	60	92	1	181.160.11
20	60	92	1	181.200.11

## 173-182



D mm	I mm	L mm		ORDER NO. S=M10x1,5
6	14	50	1	173.060.11
8	20	52	1	173.080.11
10	22	52	1	173.100.11
12	22	52	1	173.120.11
14	25	52	1	173.140.11
15	25	52	1	173.150.11
16	25	52	1	173.160.11
18	25	52	1	173.180.11
20	25	52	1	173.200.11
22	25	52	1	173.220.11
25	25	52	1	173.250.11
30	25	52	1	173.300.11
8	35	67	1	182.080.11
10	35	67	1	182.100.11
12	35	67	1	182.120.11
14	35	67	1	182.140.11
16	45	77	1	182.160.11
18	45	77	1	182.180.11
20	45	77	1	182.200.11

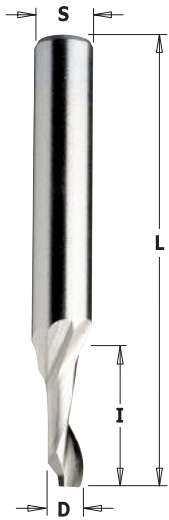

**188**

**HSS Z1 RH**

D mm	I mm	L mm		ORDER NO. S=Ø8mm
3	12	60	50	<b>188.030.51</b>
4	12	60	50	<b>188.040.51</b>
4	40	100	1	<b>188.041.51</b>
5	14	60	50	<b>188.050.51</b>
5	40	100	1	<b>188.051.51</b>
6	14	60	50	<b>188.060.51</b>
6	40	100	1	<b>188.061.51</b>
7	14	60	50	<b>188.070.51</b>
8	14	80	50	<b>188.080.51</b>
8	40	100	1	<b>188.081.51</b>
9	14	80	50	<b>188.090.51</b>
10	14	80	50	<b>188.100.51</b>
12	14	80	50	<b>188.120.51</b>

Suggested MAX RPM 12.000

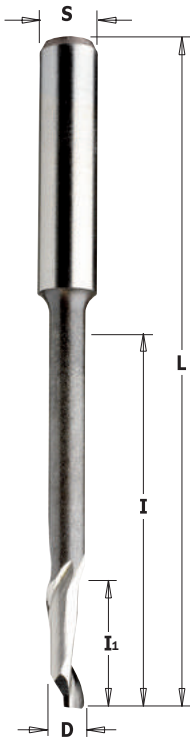

**189** 5% Co HS Spiral Bits for High Cutting Depth

**HSS Z1 RH**

D mm	I mm	I <sub>1</sub> mm	L mm	S mm		ORDER NO.
4	46	16	90	8	1	<b>189.040.51</b>
5	35	18	80	8	50	<b>189.050.51</b>
5	35	14	120	8	1	<b>189.051.51</b>
5	55	16	90	8	1	<b>189.052.51</b>
6	45	16	90	8	1	<b>189.060.51</b>
8	68	14	100	8	1	<b>189.080.51</b>
8	55	14	80	8	50	<b>189.081.51</b>
10	95	14	120	10	1	<b>189.100.51</b>
10	70	30	100	10	1	<b>189.101.51</b>

Suggested MAX RPM 12.000

**TECHNICAL DETAILS:**

- 5% Co premium solid HS
- 1 upcut spiral cutting edge
- Upward chip ejection

**APPLICATION:** these tools feature single flute design allowing efficient and effective carving on all types of aluminium. This translates into greater flexibility, enhanced productivity and superb quality finishing.

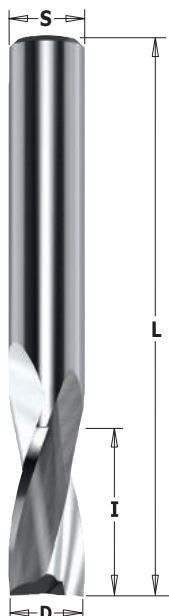

Solid Carbide Upcut Spiral Bits for Aluminum and PVC

**186**

**MIRROR FINISH HWM Z2 RH**

D mm	I mm	L mm	S mm		ORDER NO. Right-hand rotation
4	10	60	6	10	<b>186.640.11</b>
5	12	60	6	10	<b>186.650.11</b>
6	15	60	6	10	<b>186.060.11</b>
8	20	60	8	10	<b>186.080.11</b>
10	22	72	10	10	<b>186.100.11</b>
12*	25	83	12	10	<b>186.120.11</b>
14*	25	82	14	10	<b>186.140.11</b>
16*	25	82	16	10	<b>186.160.11</b>

\* with seat for seeger retention ring

**TECHNICAL DETAILS:**

- Premium quality HWM
- 2 spiral cutting edges [Z2]
- Extra-fine finish
- Upward chip ejection

**APPLICATION:** used for ripping, template routing and panel sizing on plastic materials and aluminum at high feed speed.

Can be used on machining centers, point to point machines, CNC routers and hand held routers equipped with chucks or adapters.

# Straight Router Bits with Insert Knives

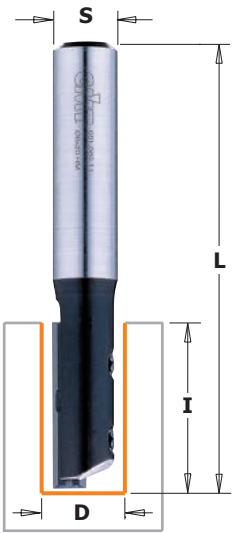

## 651-652

Straight router bit with one replaceable mini knife and fixing wedge. Radial and axial groove for better and safe knife insertion. For finishing, routing and grooving in board materials (DTD laminated, MDF and hardwood). For use on portable routers or CNC machining centres.

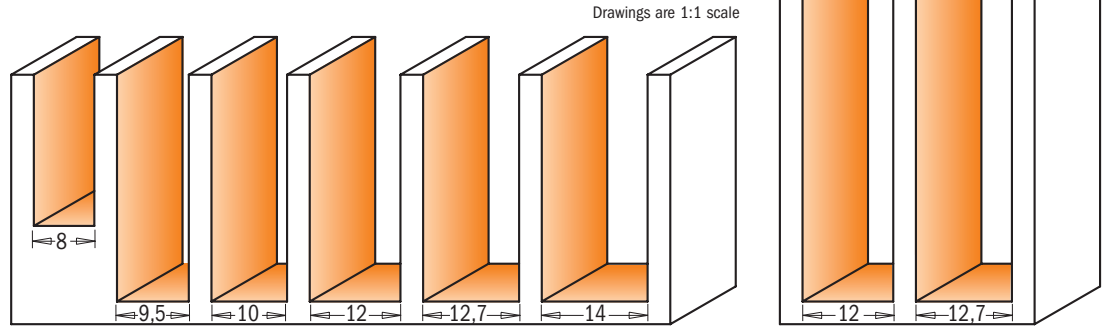

D mm	I mm	L mm		ORDER NO. S=Ø6,35mm	ORDER NO. S=Ø8mm	ORDER NO. S=Ø12mm	ORDER NO. S=Ø12,7mm	Spare parts							
8	20	60	10	<b>651.079.11</b>								790.200.01	651.999.01	990.070.00	991.063.00
8	20	60	10		<b>651.080.11</b>			790.200.01	651.999.01	990.070.00	991.063.00	790.200.01	651.999.01	990.070.00	991.063.00
8	20	67	10			<b>651.081.11</b>	<b>651.681.11</b>	790.200.01	651.999.01	990.070.00	991.063.00	790.200.01	651.999.01	990.070.00	991.063.00
9,5	30	70	10	<b>651.095.11</b>				790.300.01	651.999.02	990.071.00	991.063.00	790.300.01	651.999.02	990.071.00	991.063.00
9,5	30	80	10				<b>651.695.11</b>	790.300.01	651.999.02	990.071.00	991.063.00	790.300.01	651.999.02	990.071.00	991.063.00
10	30	70	10		<b>651.100.11</b>			790.300.01	651.999.02	990.071.00	991.063.00	790.300.01	651.999.02	990.071.00	991.063.00
10	30	80	10			<b>651.101.11</b>	<b>651.701.11</b>	790.300.01	651.999.02	990.071.00	991.063.00	790.300.01	651.999.02	990.071.00	991.063.00
12	30	70	10		<b>651.120.11</b>			790.300.01	651.999.02	990.071.00	991.063.00	790.300.01	651.999.02	990.071.00	991.063.00
12	30	80	10			<b>651.121.11</b>	<b>651.721.11</b>	790.300.01	651.999.02	990.071.00	991.063.00	790.300.01	651.999.02	990.071.00	991.063.00
12	50	103	10			<b>652.121.11</b>	<b>652.621.11</b>	790.500.01	651.999.03	990.016.00	991.060.00	790.500.01	651.999.03	990.016.00	991.060.00
12,7	30	70	10	<b>651.127.11</b>				790.300.01	651.999.02	990.071.00	991.063.00	790.300.01	651.999.02	990.071.00	991.063.00
12,7	30	80	10				<b>651.727.11</b>	790.300.01	651.999.02	990.071.00	991.063.00	790.300.01	651.999.02	990.071.00	991.063.00
12,7	50	103	10				<b>652.628.11</b>	790.500.01	651.999.03	990.016.00	991.060.00	790.500.01	651.999.03	990.016.00	991.060.00
14	30	73	10		<b>651.140.11</b>			790.300.01	651.999.02	990.071.00	991.063.00	790.300.01	651.999.02	990.071.00	991.063.00

# Straight Router Bits with Insert Knives for Laminates



## 652

Straight trimmer bits with one replaceable knife fixed by a Torx screw. A smart economical solution best suited for specialized applications requiring low downtime. The 29.5x9x1.5mm knives provide a 40mm cutting length by making multiple passes. For routing trimming and grooving on board materials (laminated chipboard, worktop panels and MDF). For use on portable routers.

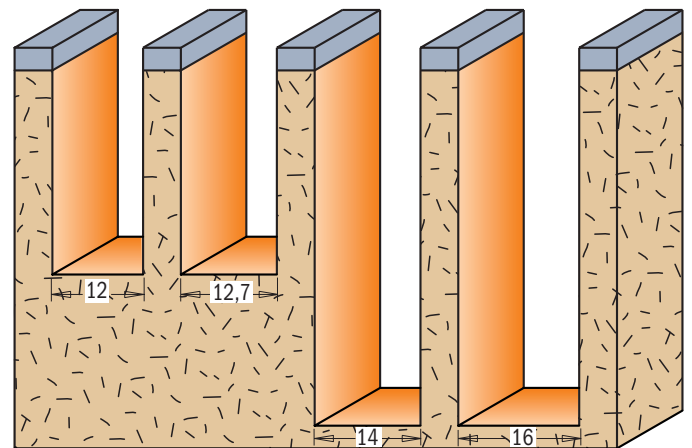
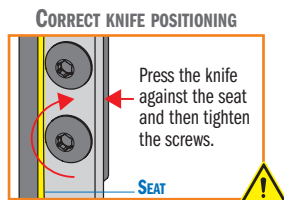

D mm	I mm	L mm		ORDER NO. S=Ø8mm	ORDER NO. S=Ø12mm	ORDER NO. S=Ø12,7mm	Spare parts					
12	29,5	79	10	<b>652.120.11</b>						790.295.09	990.072.00	991.061.00
12	39,5	90	10	<b>652.122.11</b>			790.395.09	990.072.00	991.061.00	790.295.09	990.072.00	991.061.00
12,7	29,5	89	10			<b>652.627.11</b>	790.295.09	990.072.00	991.061.00	790.295.09	990.072.00	991.061.00
14	50	96	10		<b>652.141.11</b>		790.500.09	990.072.00	991.061.00	790.500.09	990.072.00	991.061.00
16	50	96	10		<b>652.161.11</b>		790.500.09	990.072.00	991.061.00	790.500.09	990.072.00	991.061.00



# Straight Router Bits with Insert Knives

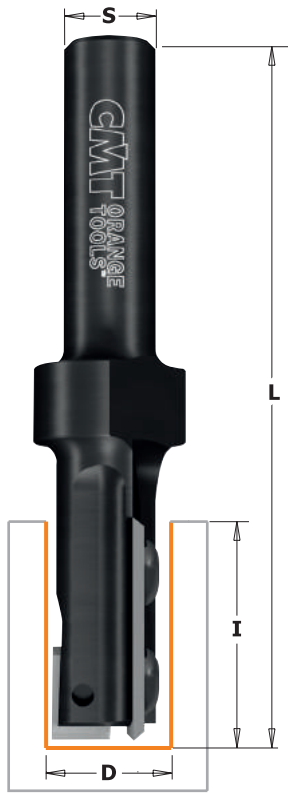

## 653

Straight router bits with a replaceable plunging knife and side knife fixed by a special Torx screw. The tool bodies are precisely balanced. For finishing, routing, plunging and grooving on board materials (laminated chipboards and MDF) and hardwood. For use on portable routers or CNC machining centres.

### CORRECT KNIFE POSITIONING

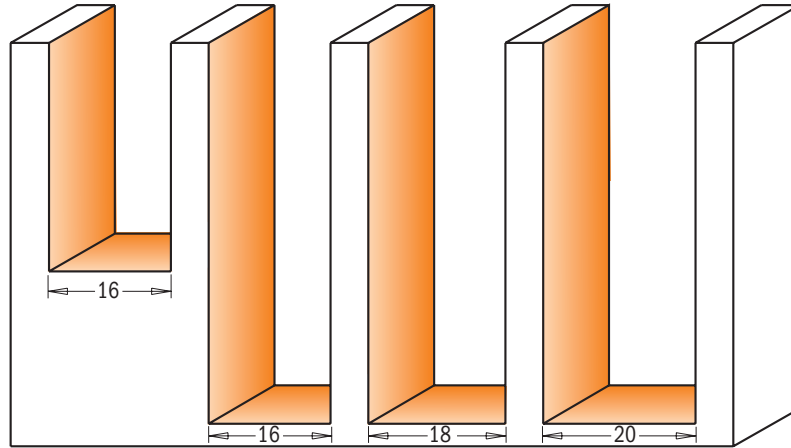
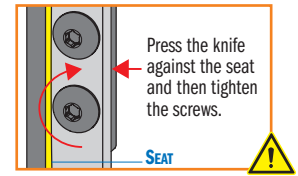

Drawings are 1:1 scale

D mm	I mm	L mm		ORDER NO. S=Ø8mm	ORDER NO. S=Ø12mm	ORDER NO. S=Ø12,7mm	ORDER NO. S=Ø20mm	Spare parts								
15,8	28,3	92	10			<b>653.158.11</b>		790.283.12	990.074.00	990.075.00	790.075.00	990.072.00	991.061.00			
15,8	48,3	112	10			<b>653.159.11</b>		790.483.12	990.074.00	990.075.00	790.075.00	990.072.00	991.061.00			
16	28,3	82	10	<b>653.160.11</b>				790.283.12	990.074.00	990.075.00	790.075.00	990.072.00	991.061.00			
16	28,3	92	10		<b>653.161.11</b>		<b>653.661.11</b>	790.283.12	990.074.00	990.075.00	790.075.00	990.072.00	991.061.00			
16	48,3	111,5	10		<b>653.162.11</b>		<b>653.662.11</b>	790.483.12	990.074.00	990.075.00	790.075.00	990.072.00	991.061.00			
18	48,3	111,5	10				<b>653.681.11</b>	790.483.12	990.074.00	990.075.00	790.075.00	990.072.00	991.061.00			
20	48,3	111,5	10				<b>653.701.11</b>	790.483.12	990.074.00	990.075.00	790.096.00	990.072.00	991.061.00			

# Straight Router Bits with Insert Knives

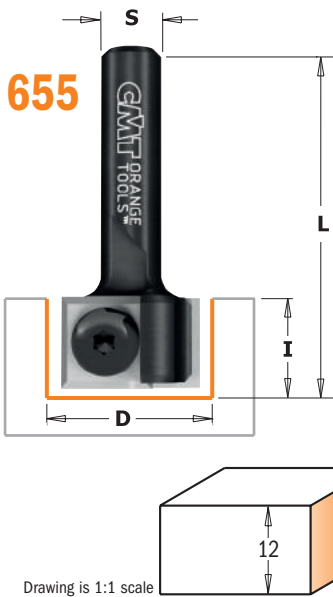

Drawing is 1:1 scale

## 654



Straight router bit with two replaceable knives fixed by special Torx screws. The blades are sharpened at a 3° angle for better plunging operations.

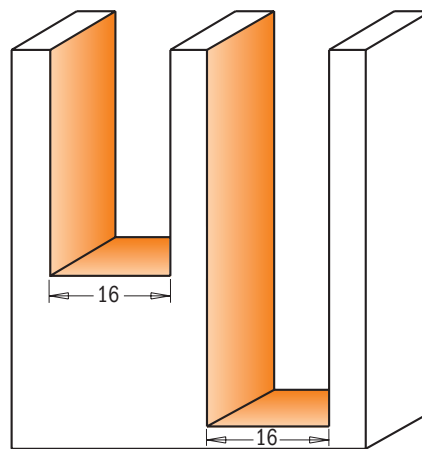

Drawings are 1:1 scale

### CORRECT KNIFE POSITIONING

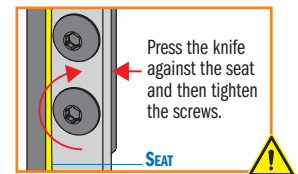

D mm	I mm	L mm		ORDER NO. S=Ø8mm	ORDER NO. S=Ø12mm	ORDER NO. S=Ø12,7mm	ORDER NO. S=Ø20mm	Spare parts		
16	28,3	76	10	<b>654.160.11</b>				790.283.12	990.073.00	991.061.00
16	28,3	87	10		<b>654.161.11</b>	<b>654.661.11</b>		790.283.12	990.073.00	991.061.00
16	48,3	105	10		<b>654.162.11</b>		<b>654.662.11</b>	790.483.12	990.073.00	991.061.00
19	12	45	10	<b>655.190.11</b>				790.120.00	990.075.00	991.061.00



## 7/8/901B

Equipped with thick carbide tips and negative shear angle design, CMT mortising bits guarantee flawless performance. Mortise perfect hinges with no splintered edges or rough bottoms. Mortising is a breeze on both natural wood and wood composites. Compatible with most mortising jigs. Complete with a top bearing guide, these bits are the perfect tool for sign making and template work.

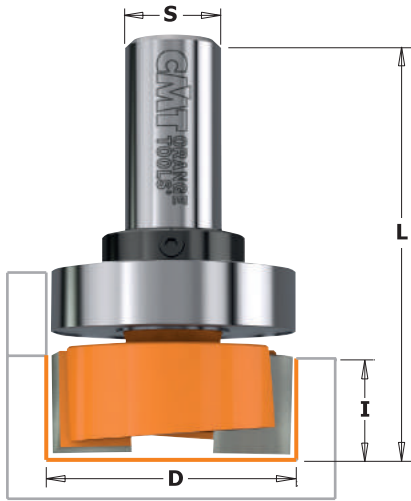

The CMT mortising bit is an essential tool for traditional hinge installation.

## 7/8/901

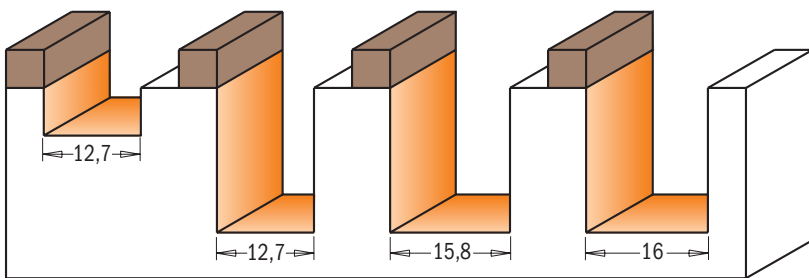

Drawings are 1:1 scale

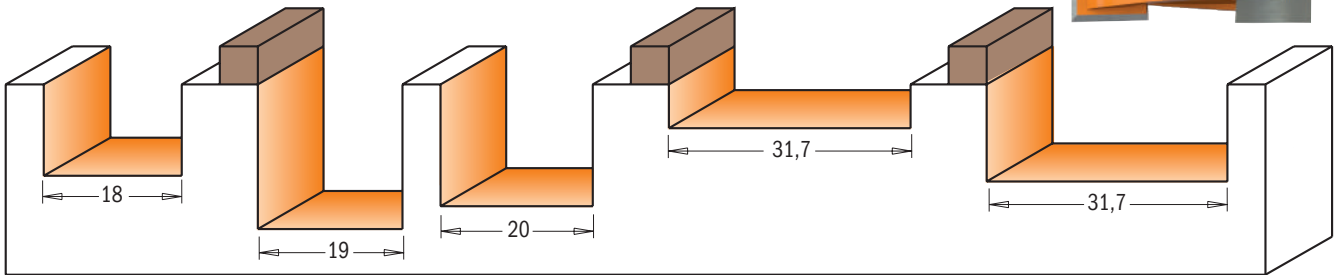

D mm	I mm	L mm		ORDER NO. S=Ø6mm	ORDER NO. S=Ø6,35mm	ORDER NO. S=Ø8mm	ORDER NO. S=Ø12mm	ORDER NO. S=Ø12,7mm
12,7	6,35	41	10		<b>801.128.11</b>			
12,7	19	54	10	<b>701.127.11</b>	<b>801.127.11</b>	<b>901.127.11</b>		
12,7	19	60	10				<b>901.627.11</b>	<b>801.627.11</b>
15,8	19	57	10		<b>801.158.11</b>			
16	19	54	10	<b>701.160.11</b>		<b>901.160.11</b>		
18	16	48	10	<b>701.180.11</b>		<b>901.180.11</b>		
19	19	54	10	<b>701.190.11</b>	<b>801.190.11</b>	<b>901.190.11</b>		
19	19	57	10					<b>801.690.11</b>
20	16	48	10	<b>701.200.11</b>		<b>901.200.11</b>		
31,7	5,7	63	10					<b>801.818.11</b>
31,7	12,7	48	10		<b>801.317.11</b>			
31,7	12,7	54	10				<b>901.817.11</b>	<b>801.817.11</b>

Spare parts



With top bearing

12,7	6,35	41	10		<b>801.128.11B</b>				791.010.00	541.001.00	991.056.00
12,7	19	54	10		<b>801.127.11B</b>				791.010.00	541.001.00	991.056.00
15,8	19	57	10		<b>801.158.11B</b>				791.009.00	541.001.00	991.056.00
16	19	54	10			<b>901.160.11B</b>			791.025.00	541.004.00	991.056.00
19	19	54	10	<b>701.190.11B</b>					791.007.00	541.003.00	991.056.00
19	19	54	10		<b>801.190.11B</b>				791.004.00	541.001.00	991.056.00
31,7	5,7	63	10					<b>801.818.11B</b>	791.015.00	541.002.00	991.056.00
31,7	12,7	54	10					<b>801.817.11B</b>	791.015.00	541.002.00	991.056.00

# Hinge Recesser Bits



## 7/902



CMT hinge recesser bits are ideal for shallow lateral routing cuts such as recessing hinges.

**SHOP TIPS:** comers will require final square with a hand or a corner chisel.

*Ideal for hinge recessing*

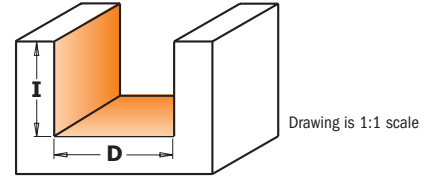
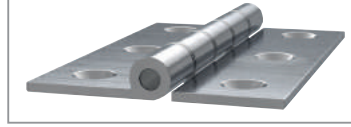

Drawing is 1:1 scale

The special construction allows good chip clearance and plunging.



D mm	I mm	L mm		ORDER NO. S=Ø6mm	ORDER NO. S=Ø8mm
12	12	38	10	702.120.11	902.120.11
13	12	38	10	702.130.11	902.130.11
14	12	38	10	702.140.11	902.140.11
15	12	38	10	702.150.11	902.150.11
16	12	38	10	702.160.11	902.160.11
18	12	38	10	702.180.11	902.180.11
20	11	38	10	702.200.11	902.200.11
22	11	38	10	702.220.11	902.220.11
23	11	38	10	702.230.11	902.230.11
24	11	38	10	702.240.11	902.240.11
25	11	38	10	702.250.11	902.250.11

# Dado & Planer Bits



## 852B

## 852



Thick carbide tips and downward shear angle provide exceptional performance and quality. The negative shear angle on the cutting edges push the wood fibers down as they cut. This means perfect hinge mortises, no splintered edges or rough bottoms. Mortising is easy on both natural wood and wood composites. Our bits fit the most popular mortising jigs.

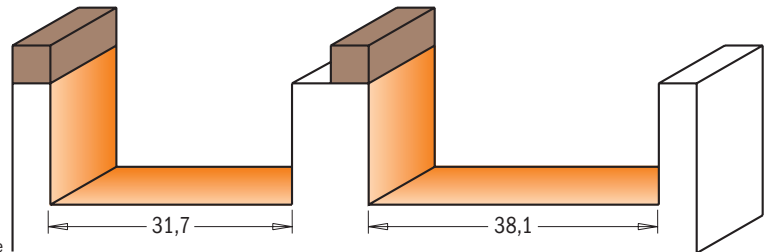
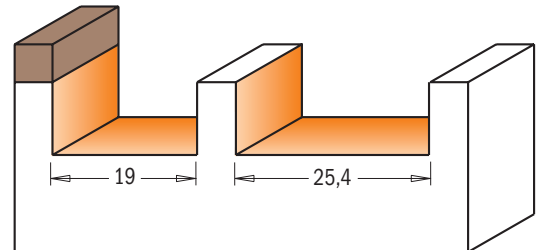

Drawings are 1:1 scale

D mm	I mm	L mm		ORDER NO. S=Ø6,35mm	ORDER NO. S=Ø12,7mm
19	9,5	57	10	852.001.11	
19	9,5	63,5	10		852.501.11
25,4	9,5	57	10		852.502.11
31,7	15,8	70	10		852.503.11
38,1	15,8	70	10		852.504.11

*With top bearing*

19	9,5	57	10	852.001.11B	
19	9,5	63,5	10		852.501.11B
31,7	15,8	70	10		852.503.11B
38,1	15,8	70	10		852.504.11B

*Spare parts*

791.004.00	541.001.00	991.056.00
791.011.00	541.002.00	991.056.00
791.015.00	541.002.00	991.056.00
791.020.00	541.002.00	991.056.00



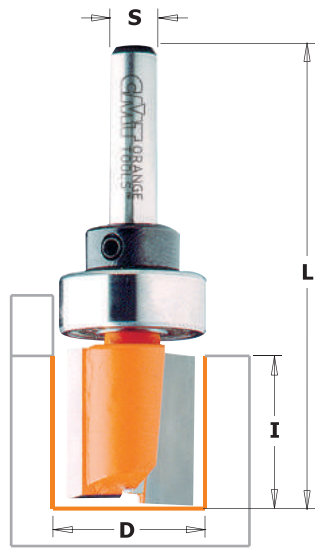

## 7/8/911B

Whether you're a full-time professional woodworker or part-time woodworking enthusiast, the CMT pattern bit is a valuable tool providing unlimited template routing possibilities. Pair up these double-fluted bits with a template of your choice and produce distinctive cabinets, furniture pieces, signs, toys and personalize any other creative project. Carbide tipped for long lasting performance, CMT pattern bits are also equipped with a top bearing providing you with a clear view throughout the routing process so you can work confidently and accurately.

**SAFETY TIPS:** make sure your router is in top condition. The template must be securely fastened to the workpiece. When choosing a bit, carefully consider the thickness of the template and all the implications of the cut. Opt for the shortest bit possible for the project you are working on.

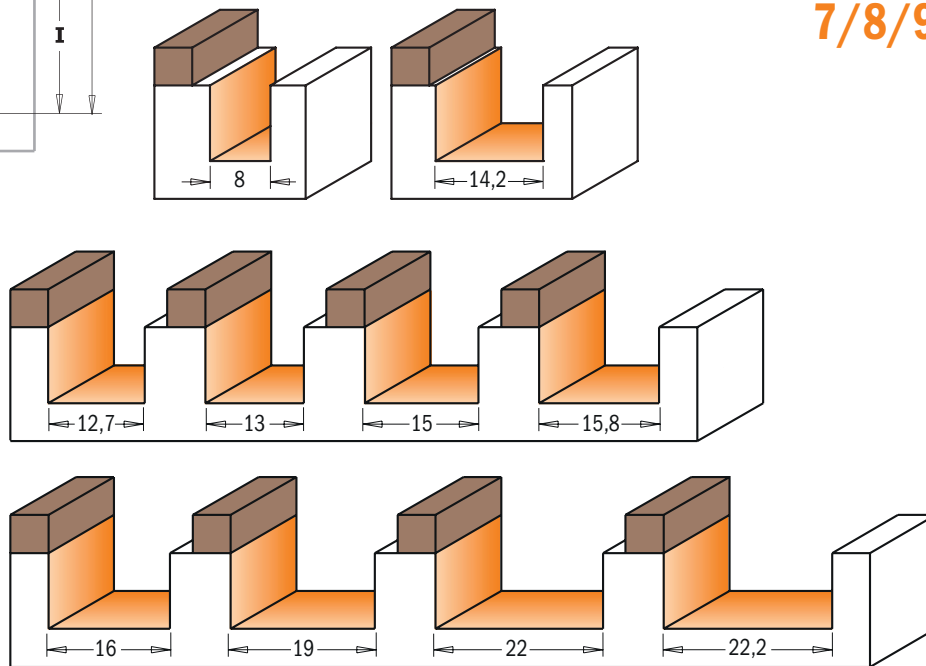

Drawings are 1:1 scale

## 7/8/912B



D mm	I mm	L mm		ORDER NO. S=Ø6mm	ORDER NO. S=Ø6,35mm	ORDER NO. S=Ø8mm	ORDER NO. S=Ø12mm	ORDER NO. S=Ø12,7mm
8	25,4	70	10		<b>811.081.11B</b>			
12,7	19	57,2	10		<b>811.127.11B</b>			
13	20	57	10	<b>711.130.11B</b>				
14,2	14,2	57,2	10		<b>811.142.11B</b>			
15	20	57	10	<b>711.150.11B</b>				
15,8	12,7	58	10		<b>811.159.11B</b>			
15,8	19	66,5	10		<b>811.158.11B</b>			
16	20	57	10			<b>911.160.11B</b>		
19	20	57	10	<b>711.190.11B</b>				
19	20	57,2	10		<b>811.191.11B</b>			
19	25,4	63,5	10					<b>811.690.11B</b>
22	20	57	10			<b>911.220.11B</b>		
22,2	25,4	66,5	10					<b>811.222.11B*</b>
<b>Long Series</b>								
12,7	31,7	70	10		<b>812.127.11B</b>			
15	31,7	66,5	10	<b>712.150.11B</b>				
15,8	31,7	70	10		<b>812.158.11B</b>			
16	31,7	66,5	10			<b>912.160.11B</b>		
19	38,1	82,5	10				<b>912.690.11B</b>	
19	38,1	82,5	10					<b>812.690.11B</b>
19	50,8	92	10				<b>912.691.11B</b>	
19	50,8	92	10					<b>812.691.11B</b>

Spare parts



791.010.00	541.001.00	991.056.00
791.010.00	541.001.00	991.056.00
791.023.00	541.003.00	991.056.00
791.009.00	541.001.00	991.056.00
791.024.00	541.003.00	991.056.00
791.009.00	541.001.00	991.056.00
791.009.00	541.001.00	991.056.00
791.009.00	541.001.00	991.056.00
791.025.00	541.004.00	991.056.00
791.007.00	541.003.00	991.056.00
791.004.00	541.001.00	991.056.00
791.011.00	541.002.00	991.056.00
791.005.00	541.004.00	991.056.00
791.021.00	541.006.00	991.056.00
791.010.00	541.001.00	991.056.00
791.024.00	541.003.00	991.056.00
791.009.00	541.001.00	991.056.00
791.025.00	541.004.00	991.056.00
791.011.00	541.005.00	991.056.00
791.011.00	541.002.00	991.056.00
791.011.00	541.005.00	991.056.00
791.011.00	541.002.00	991.056.00

■ This item requires a slightly larger bearing than its cutting diameter

\*Ø9,5mm shanks with Ø9,5/12,7mm bushings (799.001.00)

# Pattern Router Bits with Insert Knives

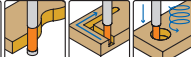



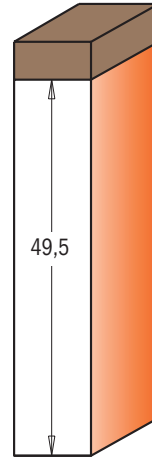
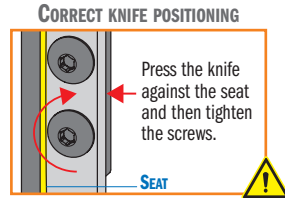

INSERT CARBIDE **Z1** **Z2** **RH**  **2X LONGER LIFE**

## 652B

Straight router bits with a replaceable knife fixed by a Torx screw. An economical solution for specialized applications requiring low downtime. They are equipped with top bearing for template use. For routing, trimming and grooving in board materials (laminated chipboards, worktop panels, MDF). For use on portable routers.



Drawing is 1:1 scale

D mm	I mm	L mm	Z		ORDER NO. S=Ø12mm	ORDER NO. S=Ø12,7mm	Spare parts											
19	49,5	100	1	10	<b>652.690.11B</b>	<b>652.691.11B</b>							790.495.09	990.072.00	991.061.00	791.011.00	541.002.00	991.056.00
<b>new</b> 28,6	49,5	100	2	10		<b>652.787.11B</b>		790.495.09	990.076.00	991.061.00	791.027.00	541.002.00	991.056.00					

# Pattern Router Bits with Insert Knives for Laminates





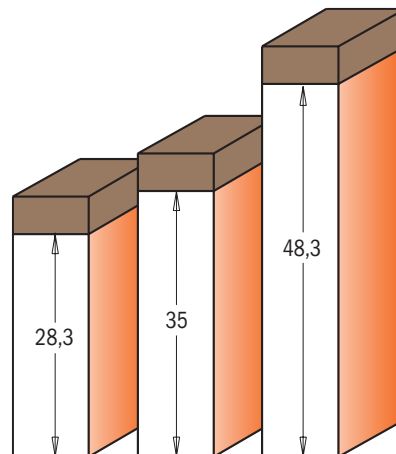
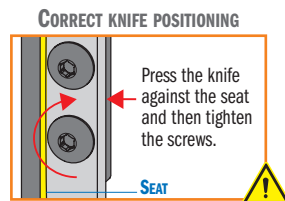

## 656

This bit type is equipped with top bearing for template use. For finishing, routing and grooving in board materials (laminated chipboards, MDF) and hardwood. For use on portable routers or CNC machining centres.

INSERT CARBIDE **Z2** **RH**  **2X LONGER LIFE**

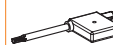

Drawings are 1:1 scale

D mm	I mm	L mm		ORDER NO. S=Ø8mm	ORDER NO. S=Ø12mm	ORDER NO. S=Ø12,7mm	Spare parts											
16	35	80	10	<b>656.160.11</b>									790.283.12	990.076.00	991.061.00	791.025.00	541.004.00	991.056.00
19	28,3	69	10	<b>656.190.11</b>			790.283.12	990.075.00	991.061.00	791.034.00	541.004.00	991.056.00						
19	28,3	79	10			<b>656.691.11</b>	790.283.12	990.075.00	991.061.00	791.011.00	541.002.00	991.056.00						
19	48,3	100	10		<b>656.692.11</b>	<b>656.693.11</b>	790.483.12	990.075.00	991.061.00	791.011.00	541.002.00	991.056.00						



Make your house more energy efficient by insulating old doors and windows. A CMT Weatherseal bit is the perfect bit to re-groove door and window frames to accommodate wind blocking inserts. Made of solid carbide for strength and endurance.

Special double-sided design lets you save money by offering two tips in one bit; with the same features as the one-sided weatherseal bit. Only available with a 3mm (1/8") cutting diameter.

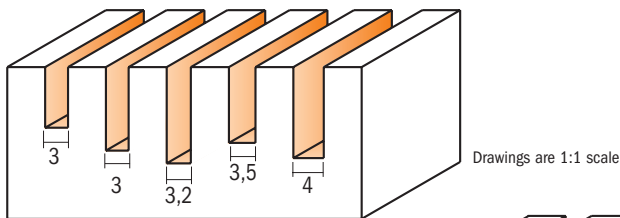

Drawings are 1:1 scale

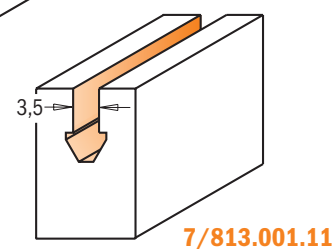

7/813.001.11



D mm	I mm	L mm		ORDER NO. S=Ø6mm	ORDER NO. S=Ø6,35mm
3	8	76	10	<b>711.031.11</b>	
3	11	60	10	<b>712.030.11</b>	
3,2	12,7	50,8	10		<b>812.032.11</b>
3,5	12	60	10	<b>191.635.11</b>	
4	12	60	10	<b>712.040.11</b>	
3,5	8	76	10	<b>713.001.11</b>	
3,5	8	63,5	10		<b>813.001.11</b>

# Combination Trimmer Bits



## 7/8/921

Work to your highest standards with the CMT combination trimmer bits. Now you can cut, trim and bevel all laminates without having to change the bit. Achieve great results when making straight or angled cuts on both soft and hard-wood. Three popular sizes, each with carbide-tipped cutting edges for efficient bevel and straight trimming.

**NOTICE:** these bits must be used with an edge, separate guide or fence.

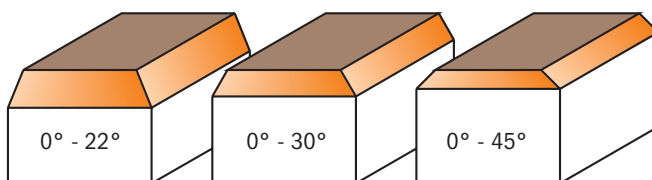
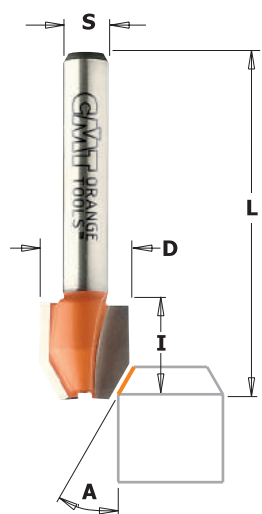

Drawings are 1:1 scale

A	D mm	I mm	L mm		ORDER NO. S=Ø6mm	ORDER NO. S=Ø6,35mm	ORDER NO. S=Ø8mm
0° - 22°	12	12,7	44,5	10	<b>721.022.11</b>	<b>821.022.11</b>	
0° - 30°	12	12,7	44,5	10	<b>721.030.11</b>	<b>821.030.11</b>	<b>921.030.11</b>
0° - 45°	12	12,7	44,5	10	<b>721.045.11</b>	<b>821.045.11</b>	



# Combination Trimmer Bits

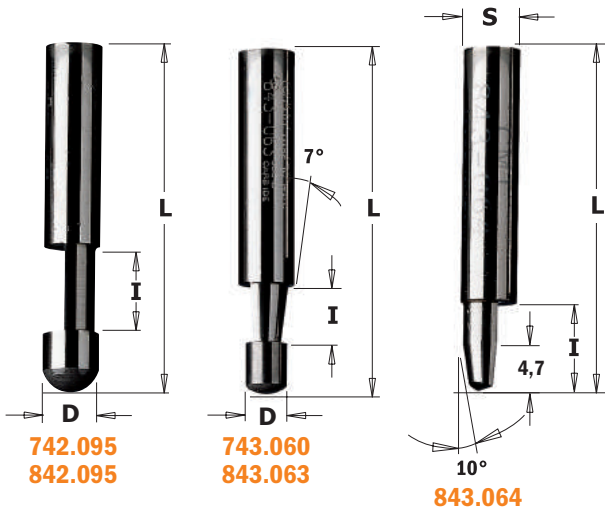

## 7/842 - 7/843



Work to your highest standards with CMT combination trimmer bits. Now you can cut, trim and bevel all laminates without having to change the bit. Achieve great results when making straight or angled cuts on both soft and hardwood. Three popular sizes, each with carbide-tipped edges guarantee efficient bevels and straight trimming.

**NOTICE:** these bits must be used with an edge, separate guide or fence.

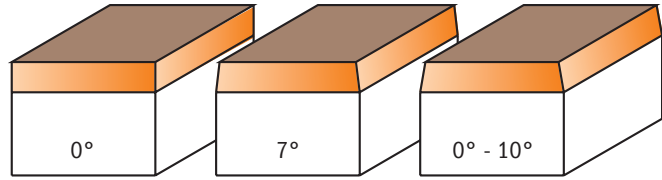

Drawings are 1:1 scale

A	D mm	I mm	L mm		ORDER NO. S=Ø6mm	ORDER NO. S=Ø6,35mm
0°	6	9,5	38	10	<b>742.095.11</b>	<b>842.095.11</b>
0°	6,35	9,5	38	10		<b>842.095.11</b>
7°	4,5 - 6	6	38	10	<b>743.060.11</b>	
7°	4,76 - 6,35	6,35	38	10		<b>843.063.11</b>
0° - 10°	6,35	9,5	38	10		<b>843.064.11</b>
<b>50 pc. masterpack</b>						
0°	6,35	9,5	38			<b>842.095.11-X50</b>
7°	4,76 - 6,35	6,35	38			<b>843.063.11-X50</b>



50 pc. masterpack

# Combination Trimmer Bits

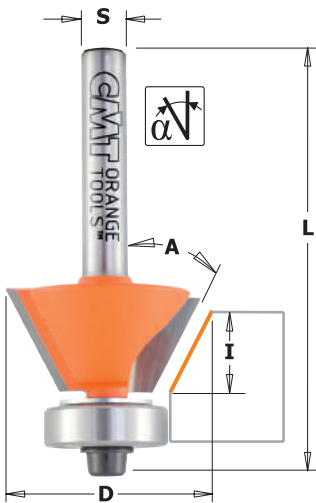

## 7/907 - 7/8/909 - 7/910

CMT's combination flush and bevel trim bits are perfect for executing superb precision finishing on laminates with ease. Achieve a great variety of angles without even changing the bit. Simply lower the bit cutting depth for precise right angle cuts or raise it to create rounded edges. Suitable for both soft and hardwood.

These bits include a ball bearing guide for easy template work and serve to protect your workpiece. They feature two flutes for executing smoother cuts and for rounding off table legs and other soft areas on furniture susceptible to damage.

**SHOP TIPS:** oversized bearing to use after resharpening.  
791.062.00 Ø9,3 replace bearing 791.002.00 (Ø9,5) after resharpening



7/907.210

7/809.016

809.023  
Z3

809.022  
809.025  
7/909.260  
7/910.260

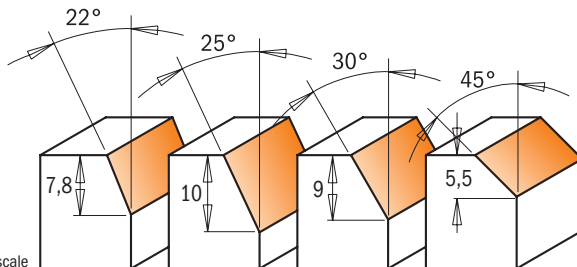

Drawings are 1:1 scale

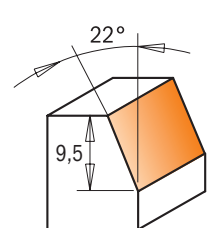
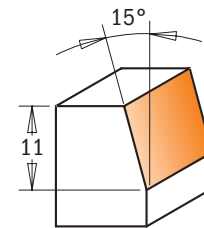
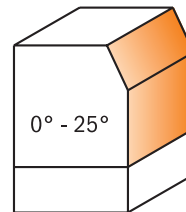

A	D mm	I mm	L mm	Z		ORDER NO. S=Ø6mm	ORDER NO. S=Ø6,35mm	ORDER NO. S=Ø8mm	Spare parts			
0° - 25°	19 - 24,5	16 (10+6)	56,5	2	10	<b>707.210.11</b>		<b>907.210.11</b>				
15°	18,6	11	57	2	10	<b>709.016.11</b>	<b>809.016.11</b>		791.007.00	990.004.00	991.062.00	
22°	12,7	7,8	47,6	2	10		<b>809.022.11</b>		990.422.00	791.044.00	990.058.00	991.057.00
22°	17,5	9,5	51	3	10		<b>809.023.11</b>			791.035.00	990.062.00	991.060.00
25°	19,05	10	52,4	2	10		<b>809.025.11</b>		990.422.00	791.002.00	990.058.00	991.057.00
30°	27	9	55	2	10	<b>709.260.11</b>		<b>909.260.11</b>	990.422.00	791.002.00	990.058.00	991.057.00
45°	27	5,5	51,5	2	10	<b>710.260.11</b>		<b>910.260.11</b>	990.423.00	791.018.00	990.058.00	991.057.00
									990.423.00	791.018.00	990.058.00	991.057.00

# Flush Trim Bits

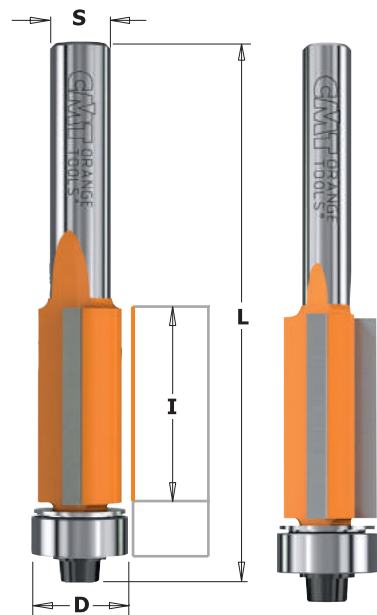

## 7/8/906

We have designed a series of truly indispensable bits available in a wide range of sizes for your woodworking needs. For precision work on laminates or quick template work with excellent finishing.

**SHOP TIPS:** these bits are excellent for making through mortises. Use a straight bit (#711.130.11) to groove the through mortise area, then use the drill bit (#517.130.31) to bore a through hole at the end of the groove. Turn the workpiece over to end the mortise. Use the flush trim bit with a cutting length slightly longer than the fillet, following the groove made on the opposite side of the workpiece with the ball bearing guide.

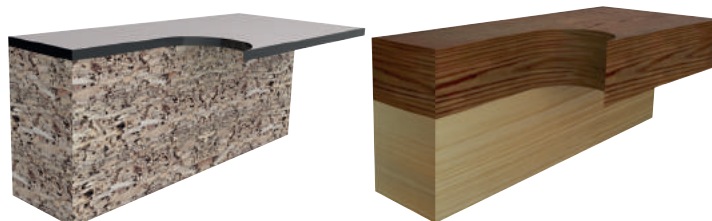
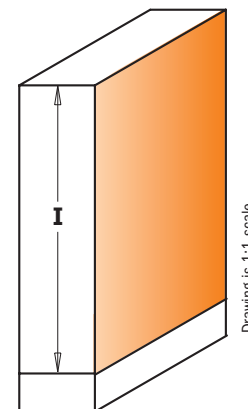

8/906.227.11  
Z3

Masterpack



• HWM

I mm	D mm	L mm	α	Box	ORDER NO. S=Ø6mm	ORDER NO. S=Ø6,35mm	ORDER NO. S=Ø8mm	ORDER NO. S=Ø12mm	ORDER NO. S=Ø12,7mm	Spare parts
•25,4	6,35	63,5	0°	10	706.064.11	806.064.11				791.035.00
12,7	9,5	55,5	0°	10	706.096.11	806.096.11	906.096.11			791.002.00
12,7	12,7	57,8	-5°	10	706.128.11	806.128.11	906.128.11			791.003.00
12,7	12,7	70,6	-5°	10				906.628.11	806.628.11	791.003.00
16	19	57,1	-5°	10	706.190.11		906.190.11			791.007.00
25,4	9,5	68,2	0°	10	706.095.11	806.095.11	906.095.11			791.002.00
25,4	12,7	70,7	-3°	10	706.127.11	806.127.11	906.127.11			791.003.00
25,4	12,7	71	0°	10		806.227.11	906.227.11			791.003.00
25,4	12,7	86,6	-3°	10				906.627.11	806.627.11	791.003.00
38,1	12,7	94	0°	10				906.629.11	806.629.11	791.003.00
50,8	12,7	104	0°	10				906.630.11	806.630.11	791.003.00
<b>10 pc. masterpack</b>										
25,4	9,5	68,2	0°			806.095.11-X10				
25,4	12,7	70,7	-3°			806.127.11-X10			806.627.11-X10	
38,1	12,7	94	0°						806.629.11-X10	

**Spare parts**  
 991.055.00 0,9mm hex key for screw (990.060.00)  
 991.057.00 3/32" hex key for screw (990.058.00)  
 991.062.00 2,5mm hex key for screw (990.004.00)

**SHOP TIPS: undersized bearing to use after resharpening.**  
 791.062.00 Ø9,3 replace bearing 791.002.00 (Ø9,5) after resharpening  
 791.063.00 Ø12,5 replace bearing 791.003.00 (Ø12,7) after resharpening

# Flush Trim Bit Set



## 806

Indispensable in any shop, the new 3 piece flush trim bit set gives you the option to trim laminates or do template work conveniently.

**Set contains:**  
 806.095.11 - 806.096.11 - 806.191.11

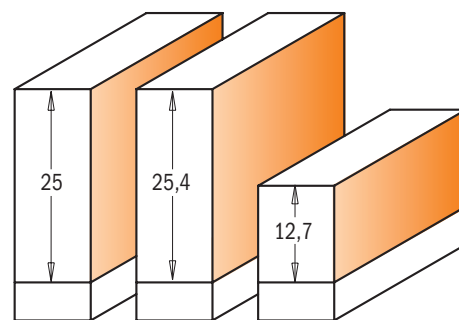

Drawings are 1:1 scale

DESCRIPTION	Box	ORDER NO. S=Ø6,35mm
Flush Trim Bit Set 9,5x12,7 - 9,5x25,4 - 19x25mm	5	806.001.11

# Super-Duty Flush Trim Bits



## 7/8/906

These new super duty bits represent the finest in the extensive line of CMT flush trim bits with ball bearing guides. A negative shear angle cutting edge and 19mm cutting diameter set CMT flush trim bits apart from standard bits. Work quickly and safely to get superior finishing with absolute minimal chipping.

**SAFETY TIPS:** dust and chips from laminate materials are hazardous to your health and safety. Always wear a dust mask and eye protection when routing.

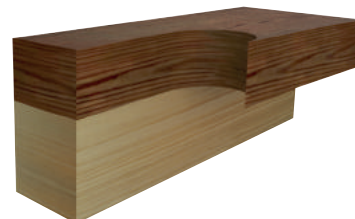
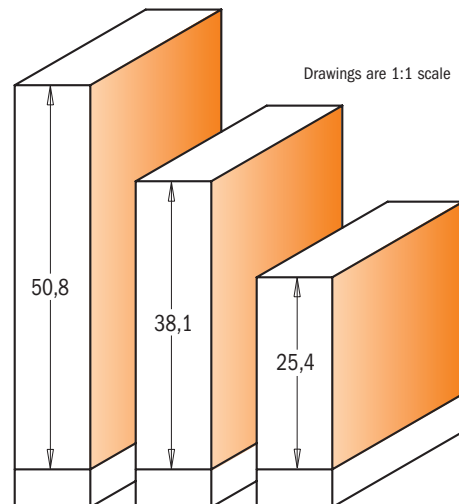

I mm	D mm	L mm	$\alpha$		ORDER NO. S=Ø6mm	ORDER NO. S=Ø6,35mm	ORDER NO. S=Ø8mm	ORDER NO. S=Ø12mm	ORDER NO. S=Ø12,7mm	Spare parts		
25,4	19	73,9	-5°	10	<b>706.191.11</b>	<b>806.191.11</b>	<b>906.191.11</b>					
25,4	19	86,5	-5°	10				<b>906.691.11</b>	<b>806.691.11</b>	791.004.00	541.550.00	990.058.00
38,1	19	92,9	-3°	10				<b>906.692.11</b>	<b>806.692.11</b>	791.004.00	541.550.00	990.058.00
50,8	19	109,5	-3°	10				<b>906.690.11</b>	<b>806.690.11</b>	791.004.00	541.550.00	990.058.00
70*	19	118,5	-3°	10				<b>906.693.11</b>		791.004.00	541.550.00	990.058.00

Spare parts 991.057.00 3/32" hex key for screw (990.058.00)

\* **Z2+1** Warning. Long cutting edges. Carefully make several shallow passes to prevent damaging the tool. The warranty does not cover improper use of the tool.

# DP Flush Trim Bits for Laminates



## 7/8/906 XTREME

These new super duty DP (polycrystalline diamond) bits represent the ultimate in the extensive line of CMT flush trim bits. Investing in CMT DP flush trim bits means saving time and money, as they last 40 times longer than conventional carbide-tipped flush trim bits.

**SHOP TIPS:** oversized bearing to use after resharpening.  
791.063.00 Ø12,5 replace bearing 791.003.00 (Ø12,7) after resharpening

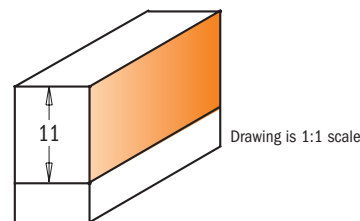

I mm	D mm	L mm		ORDER NO. S=Ø6mm	ORDER NO. S=Ø6,35mm	ORDER NO. S=Ø8mm	Spare parts			
11	12,7	58,1	10	<b>706.128.61</b>	<b>806.128.61</b>	<b>906.128.61</b>				
							990.423.00	791.003.00	990.058.00	991.057.00



# Double-Bearing Spiral Flush Trim Bits

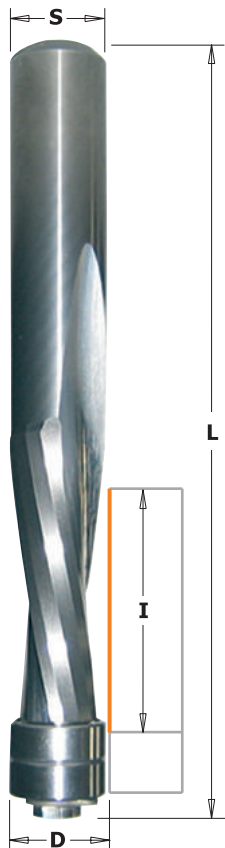

## 190B-191B-192B

CMT solid carbide spiral flush trim bits are composed of a special super-micrograin formulation increasing hardness with a higher transverse rupture point. Combined with a spiral cutting angle, CMT solid carbide spiral flush trim bits equipped with a double bearing, allow cabinet makers to shear wood and wood products cleanly, providing more efficient chip ejection than standard flush trim bits. In production settings, this means these bits will run cooler, stay sharper, last longer and increase shop productivity.

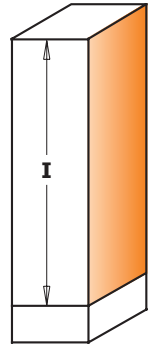
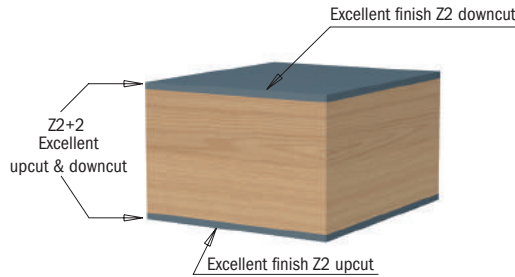

Drawing is 1:1 scale

I mm	D mm	L mm		ORDER NO. S=Ø6mm	ORDER NO. S=Ø6,35mm	ORDER NO. S=Ø12mm	ORDER NO. S=Ø12,7mm	Spare parts	
<b>Z2+2 Upcut &amp; Downcut</b>									
47	12,7	114	10			<b>190.127.11B</b>	<b>190.508.11B</b>	791.010.00	541.301.00
<b>Z2 Upcut</b>									
25,4	6,35	76,2	10	<b>191.064.11B</b>	<b>191.008.11B</b>			791.035.00	541.009.00
31,7	12,7	89	10				<b>191.505.11B</b>	791.010.00	541.301.00
50,8	12,7	114	10			<b>191.127.11B</b>	<b>191.507.11B</b>	791.010.00	541.301.00
<b>Z2 Downcut</b>									
31,7	12,7	89	10				<b>192.505.11B</b>	791.010.00	541.301.00
50,8	12,7	114	10			<b>192.127.11B</b>	<b>192.507.11B</b>	791.010.00	541.301.00

# 3-in-1 Flush Trim Bits for MDF/Laminate

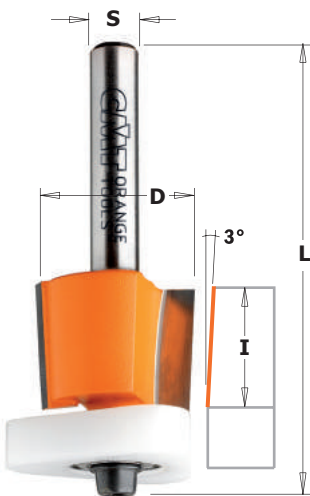

## 7/8/907

3 in 1 new flush trim bits with Delrin® Triangular bearings are your best partner for laminate trimming. In fact, it solves three of the most common problems that occur when flush trimming:

- 1) The anti-stick properties of the Delrin® bearing greatly reduces the likelihood of freezing of the bearing from glue.
- 2) The extended guide surface of the new Delrin® bearing will perfectly match the work surface without scratching like a steel bearing would. The Delrin® bearing also guarantees maximum stability.
- 3) The shear angle cutting edge reduces the need for filing. 3-in-1 bits are ideal on plastic laminates as well as aluminium laminates!

3-in-1 bits are ideal on plastic laminates as well as aluminium laminates!

**Patent No. D628,218**

- Extended guide surface
- Non-freezing
- Non-scratch surface

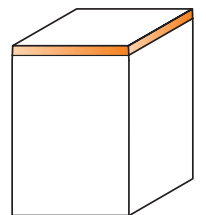

Drawing is 1:1 scale

**NON BLOCKING**

### Perfect trimming with conical edges!

Thanks to the innovative conical edges of this bit, you will always get perfect cuts even after re-sharpening. In fact, the most common problem you have with standard flush trim bits is the undersized diameter after re-sharpening which leaves a mark on the material; with the new CMT construction you could re-sharpen up to six times without any problem. Just remember to adjust your bit up or down as per the illustration.

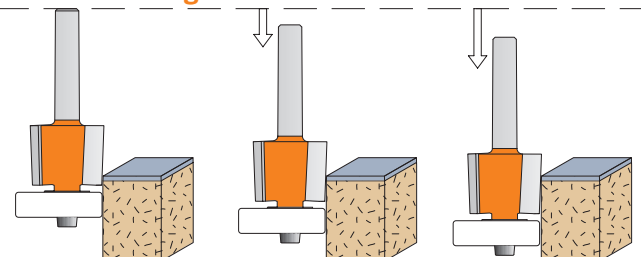

I mm	D mm	L mm		ORDER NO. S=Ø6mm	ORDER NO. S=Ø6,35mm	ORDER NO. S=Ø8mm	ORDER NO. S=Ø12,7mm	Spare parts							
12,7	12,7	54,2	10	<b>707.128.11</b>	<b>807.128.11</b>	<b>907.128.11</b>						990.422.00	791.042.00	990.058.00	991.057.00
15,87	19	59,3	10	<b>707.190.11</b>	<b>807.190.11</b>	<b>907.190.11</b>		990.423.00	791.043.00	990.058.00	991.057.00	990.423.00	791.043.00	990.058.00	991.057.00
15,87	19	65,7	10				<b>807.690.11</b>	990.423.00	791.043.00	990.058.00	991.057.00				

# Flush Trim Bits with Insert Knives



## 657.9

Flush trim bits with two replaceable knives fixed by special Torx screws. The 2-sided blades can create extra new edges. Guided flush trim bits type 657.1 are equipped with ball bearing guides.

## 657.1

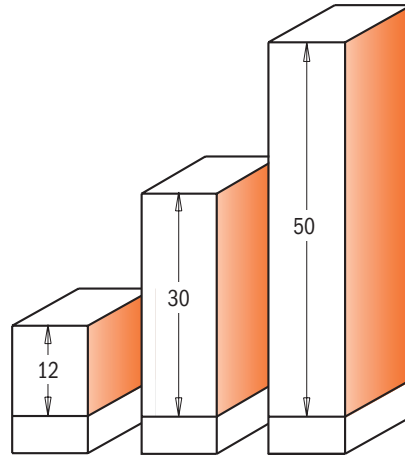
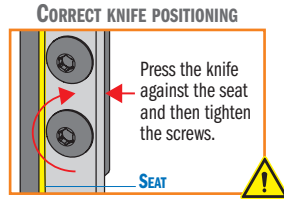

I mm	D mm	L mm		ORDER NO. S=Ø6mm	ORDER NO. S=Ø6,35mm	ORDER NO. S=Ø8mm	ORDER NO. S=Ø12mm	ORDER NO. S=Ø12,7mm	Spare parts			
12	19	57	10	657.194.11	657.192.11	657.190.11			790.120.00	990.075.00	991.061.00	791.007.00
<b>new</b> 30	16	75	10			657.161.11			790.295.09	990.115.00	991.061.00	791.006.00
30	19	76	10	657.195.11					790.300.00	990.075.00	991.061.00	791.007.00
30	19	77	10			657.191.11			790.300.00	990.075.00	991.061.00	791.007.00
30	19	87	10					657.692.11	790.300.00	990.075.00	991.061.00	791.007.00
50	19	112	10				657.991.11	657.992.11	790.500.00	990.075.00	991.061.00	791.007.00
<b>Spare parts</b>				990.400.00	Ø3.2/Ø7mm shield for M3 screw		990.052.00	M4x6mm TCEI screws				
				990.410.00	Ø4,2/Ø9mm shield for M4 screws		991.067.00	3mm hex key				
				990.051.00	M3x6mm TCEI screws		541.514.00	Ø6,4mm shield				

# FILE-FREE Flush Trim Bits for Laminate

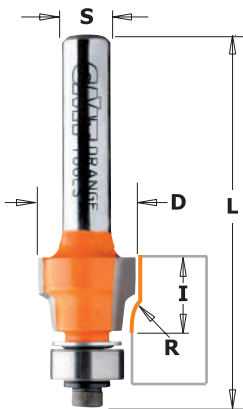

## 8/907

This bit is perfect for ensuring smooth flawless results on your laminate surfaces after flush trimming. Sharp edges are easily trimmed away, leaving your surfaces nice and smooth to the touch. No further filing is needed!

**SHOP TIPS: undersized bearing to use after resharpening.**  
791.062.00 Ø9,3 replace bearing 791.002.00 (Ø9,5) after resharpening

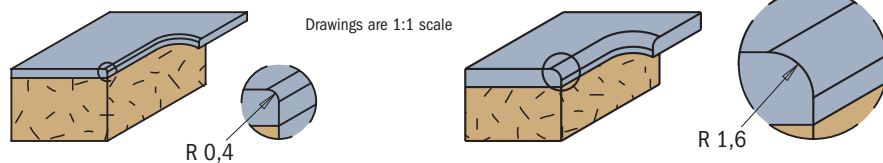

D mm	I mm	R mm	L mm		ORDER NO. S=Ø6,35mm	ORDER NO. S=Ø8mm	Spare parts				
12,7	9,5	0,4	52	10	807.004.11	907.004.11	990.422.00	791.002.00	990.058.00	991.057.00	
12,7	9,5	1,6	52	10	807.015.11	907.015.11	990.422.00	791.002.00	990.058.00	991.057.00	

Pattern/Flush Trim Bits with Insert Knives



**657B**

A flush trim bit combined with a pattern bit and fixed with Torx screws. The blades are sharpened on both sides and can provide extra new edges. Guided flush trim bits type 657 are equipped with top and bottom ball bearing guides. Recommended for flush and finishing operations.

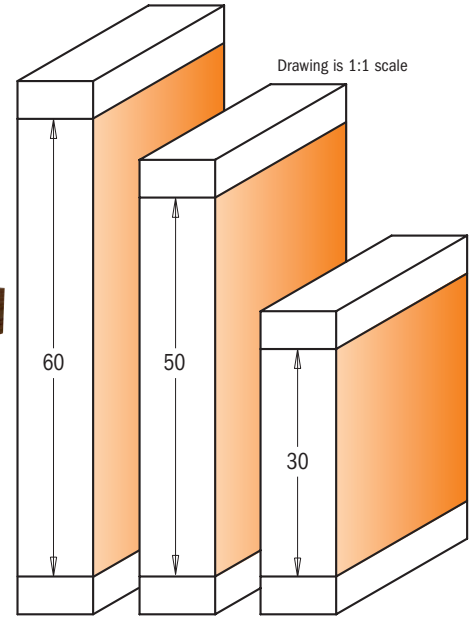
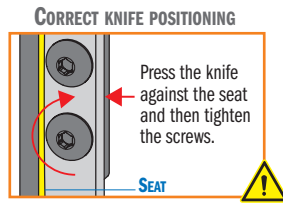
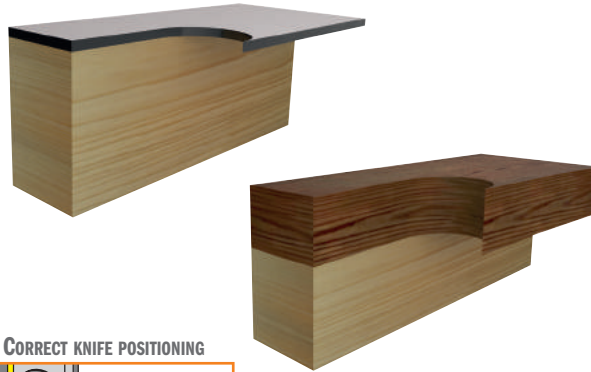

I mm	D mm	L mm	Box	ORDER NO. S=Ø8mm	ORDER NO. S=Ø12mm	ORDER NO. S=Ø12,7mm
30	19	90	10	<b>657.191.11B</b>		<b>657.692.11B</b>
30	19	90	10			<b>657.692.11B</b>
50	19	110	10		<b>657.993.11B</b>	<b>657.994.11B</b>
60	19	120	10		<b>657.995.11B</b>	<b>657.996.11B</b>

Spare parts					
790.300.00	990.075.00	791.007.00	990.052.00	791.034.00	541.004.00
790.300.00	990.075.00	791.007.00	990.052.00	791.011.00	541.002.00
790.500.00	990.075.00	791.007.00	990.052.00	791.011.00	541.002.00
790.600.00	990.075.00	791.007.00	990.052.00	791.011.00	541.002.00

Spare parts 990.410.00 Ø4,2/Ø9mm shield for M4 screws 991.061.00 T15 Torx key  
 991.067.00 3mm hex key 991.056.00 1,5mm hex key



Flush Trim Router Bits with Double Bearing

**806/906B**



The innovative two-flute router bits are equipped with a double bearing and feature a down shear design allowing cleaner, smoother cuts on a variety of materials.

Now its no longer necessary to flip or move your tool during routing operations. This tool is particularly effective when routing curved elements along or against the grain.

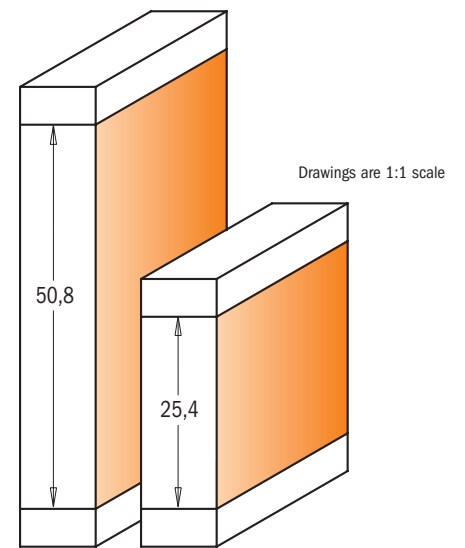

I mm	D mm	L mm	α	Box	ORDER NO. S=Ø12mm	ORDER NO. S=Ø12,7mm
25,4	19	86,5	-5°	10	<b>906.691.11B</b>	
25,4	19	86,5	-5°	10		<b>806.691.11B</b>
50,8	19	109,5	-3°	10	<b>906.690.11B</b>	
50,8	19	109,5	-3°	10		<b>806.690.11B</b>

Spare parts					
791.004.00	541.550.00	990.058.00	991.057.00	791.011.00	541.005.00
791.004.00	541.550.00	990.058.00	991.057.00	791.011.00	541.002.00
791.004.00	541.550.00	990.058.00	991.057.00	791.011.00	541.005.00
791.004.00	541.550.00	990.058.00	991.057.00	791.011.00	541.002.00





**7/8/916**

How much time do you end up spending making openings in paneling, drywall, siding, doors or windows? With the CMT panel pilot bit, the job just got quicker. The point plunges smoothly and easily and the carbide edges cut clean and fast. All of this adds up to accurate cuts in less time and with less effort - great for trimming veneer as well as a variety of laminates and HPL panels such as Formica®, Wilsonart®, Weiss®, FunderMax®.

**SAFETY TIPS:** always use extra caution when working near electrical outlets and boxes - always disconnect the current. Make sure the bit does not go so deep as to cut the wires.

**716.061**

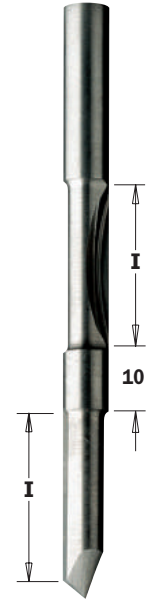
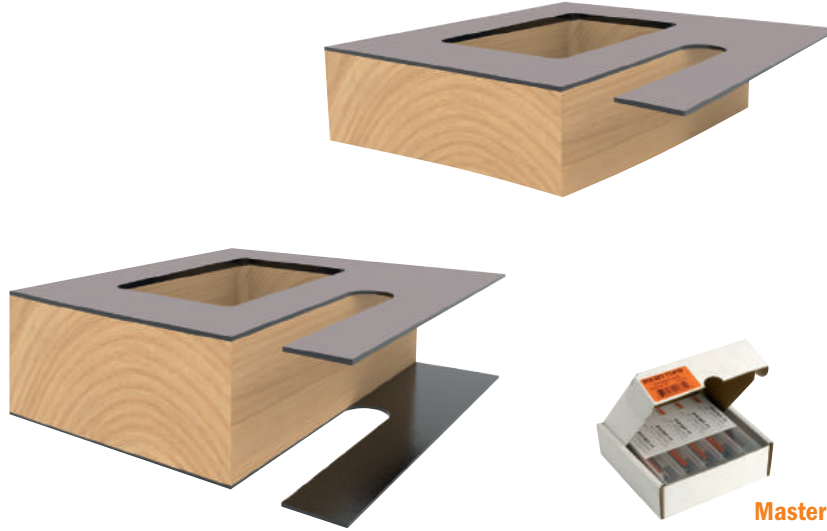
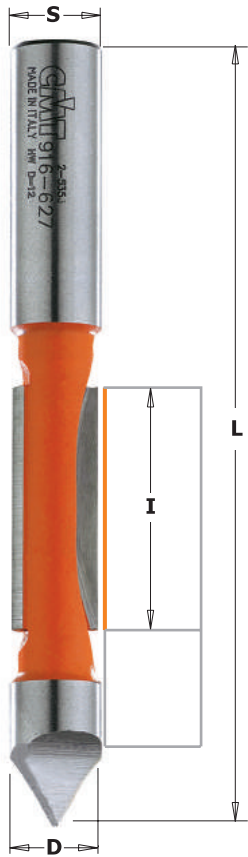

Masterpack

• HWM

D mm	I mm	L mm	Z		ORDER NO. S=Ø6mm	ORDER NO. S=Ø6,35mm	ORDER NO. S=Ø8mm	ORDER NO. S=Ø12mm	ORDER NO. S=Ø12,7mm
6	19	64	1	10	<b>716.060.11</b>				
•6	19	60	1	10	<b>716.060.21</b>				
•6	18+18	70	1+1	10	<b>716.061.11</b>				
6,35	19	64	1	10		<b>816.064.11</b>			
8	19	64	1	10			<b>916.080.11</b>		
9,53	25,4	78	2	10		<b>816.095.11</b>			
12	31,7	102	2	10				<b>916.627.11</b>	
12,7	31,7	102	2	10					<b>816.627.11</b>
<b>10 pc. masterpack</b>									
12,7	31,7	102	2						<b>816.627.11-X10</b>

Panel Pilot Bits with Guide

**7/8/953**



An absolutely indispensable bit for making cabinets. CMT Flush and V-Groove bits allow you to make cabinet front frames in 25mm stock that fit perfectly with the sides. The added V-cutter feature makes a decorative groove along the hinge joint to hide the seam.

**SHOP TIPS:** For best results, leave less than 3mm overhang on cabinet front frames for easier routing.

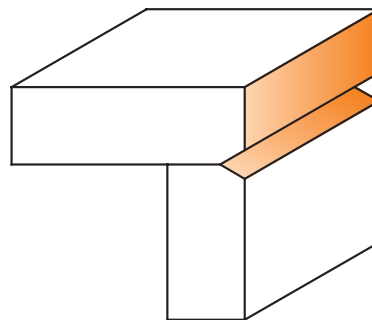
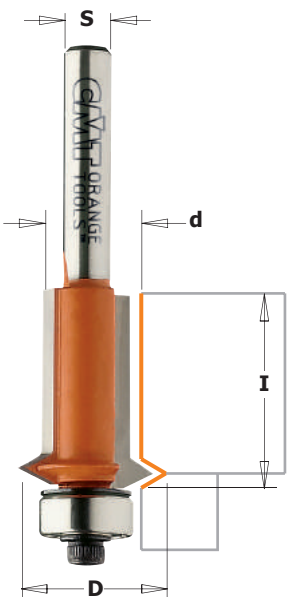

Drawing is 1:1 scale

d mm	D mm	I mm		ORDER NO. S=Ø6mm	ORDER NO. S=Ø6,35mm	ORDER NO. S=Ø8mm	ORDER NO. S=Ø12mm	ORDER NO. S=Ø12,7mm	Spare parts			
12,7	19	25,4	10	<b>753.001.11</b>	<b>853.001.11</b>	<b>953.001.11</b>	<b>953.501.11</b>	<b>853.501.11</b>				
									990.423.00	791.003.00	990.058.00	991.057.00

# The CMT Grand Rabbet Set



**8/935.503**



"The Grand Rabbet" by CMT is an investment that shows your commitment to quality. This CMT product will deliver years of reliable service under normal use. For safe and trouble-free results please observe the following instructions and safety precautions.

The complete kit (item code 835-935.503.11), will enable you to produce 17 different rabbet sizes including rabbets for under-sized plywood applications. For rabbet sizes over 12,7mm (1/2"), make the cuts in several shallow passes until the desired depth is achieved.

Available in 12mm and 12,7mm shanks.



**8/935.990**



Collar order no.  
**799.517.00**

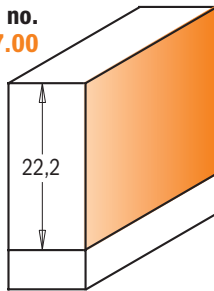

Drawings are 1:1 scale

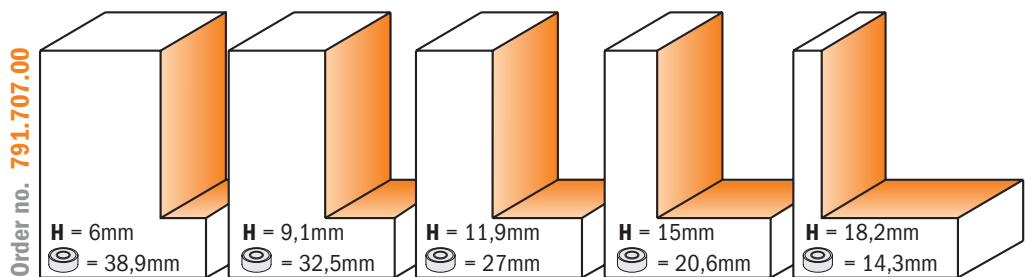
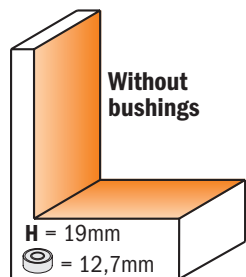
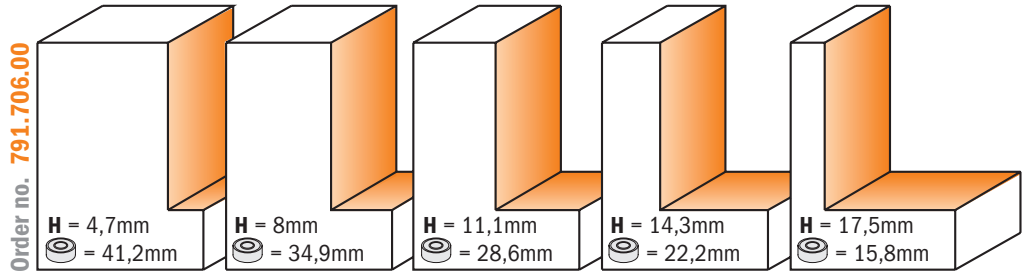
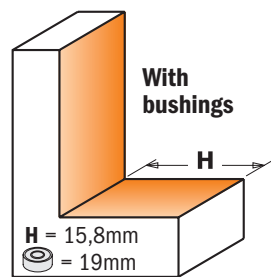
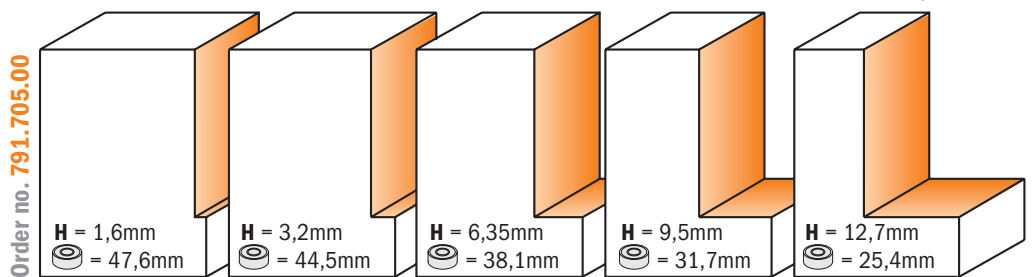

DESCRIPTION	ORDER NO. S=Ø12mm	ORDER NO. S=Ø12,7mm
The CMT Grand Rabbet Set (Ø50,8x22,2mm)	<b>935.503.11</b>	<b>835.503.11</b>
<b>SET CONTAINS:</b> The Grand Rabbet (bit only) with bushing Ø19mm	<b>935.990.11</b>	<b>835.990.11</b>
5 pcs. Bushing kits for bearing (H=1,6 - 3,2 - 6,35 - 9,5 - 12,7mm rabbets)		<b>791.705.00</b>
5 pcs. Bushing kits for bearing (H=4,7 - 8 - 11,1 - 14,3 - 17,5mm rabbets)		<b>791.706.00</b>
5 pcs. Bushing kits for bearing (H=6 - 9,1 - 11,9 - 15 - 18,2mm rabbets)		<b>791.707.00</b>
Bushing Ø50,8mm		<b>799.517.00</b>
Kit with screw, shields and keys		<b>990.452.00</b>

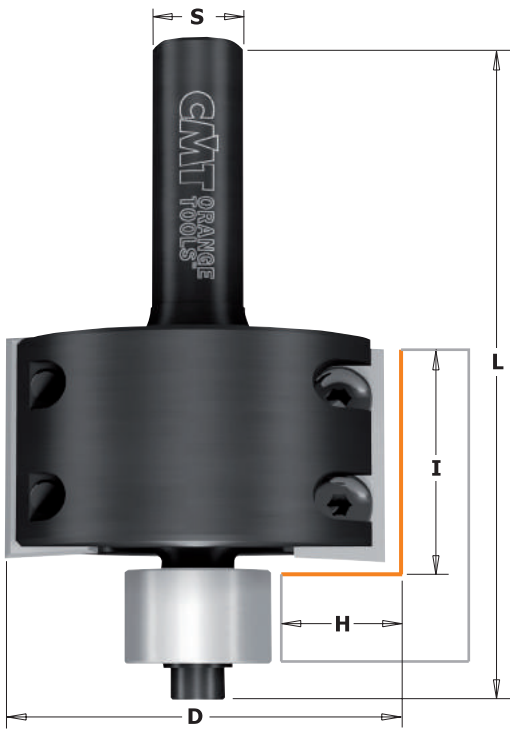

## 660.9



"The Grand Rabbit" by CMT is an investment that shows your commitment to quality. This CMT product will deliver years of reliable service under normal use. The collar sets (791.705.00-791.706.00-791.707.00) will enable you to produce 17 different rabbet sizes including rabbets for under-sized plywood applications. For rabbet sizes over 12,7mm (1/2"), make the cuts in several shallow passes until the desired depth is achieved. Available in 12mm and 12,7mm shanks.

### CORRECT KNIFE POSITIONING

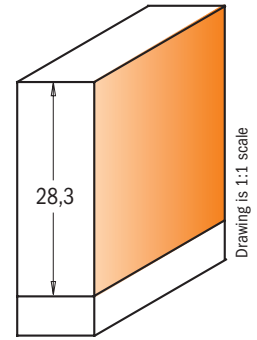
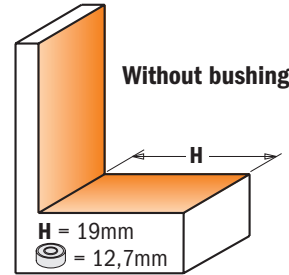
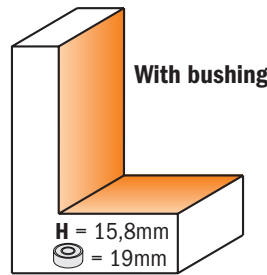
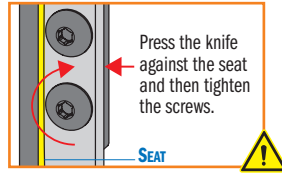

Collar order no. 799.517.00

H mm	D mm	I mm	L mm	Box	ORDER NO. S=Ø12mm	ORDER NO. S=Ø12,7mm	Spare parts							
16	50,8	28,3	86	10	660.990.11	660.991.11					790.283.12	990.075.00	991.061.00	791.010.00

**Spare parts**

541.514.00	Ø6,4mm stop collar
799.503.00	Ø19,05mm bushings
990.410.00	Ø4.2/Ø9mm shield for M4 screw
990.052.00	M4x6mm TCEI screw
991.067.00	3mm hex key
990.469.00	Kit screw, shield and key

**Optional**

799.517.00	Bushing for flush trim Ø50,8mm
791.705.00	5 pcs. bushing set (H=1,6-3,2-6,35-9,5-12,7mm rabbets)
791.706.00	5 pcs. bushing set (H=4,7-8-11,1-14,3-17,5mm rabbets)
791.707.00	5 pcs. bushing set (H=6-9,1-11,9-15-18,2mm rabbets)

## Rabbeting Bits

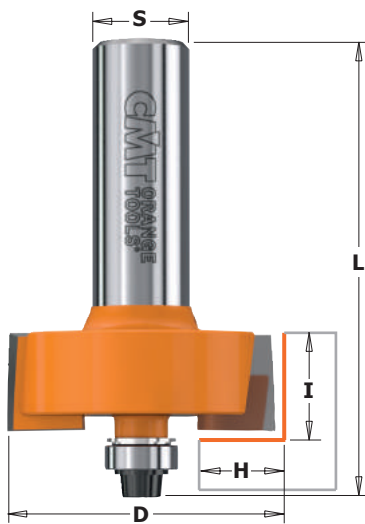

## 7/8/935



CMT carbide-faced rabbeting bits are fast and accurate - you can quickly produce inset doors and drawer fronts, make strong rabbet joints, mill perfect tongue and groove joints or any number of other jobs usually time consuming and difficult.

You can even re-groove old window frames to fit insulated glass panes with the extra long CMT 19mm (3/4") rabbeting bit. Other possibilities are illustrated below and on the following pages. Look at our slot cutters and round over bits for ideas on how to put extra finishing touches on all your grooving and rabbeting projects.

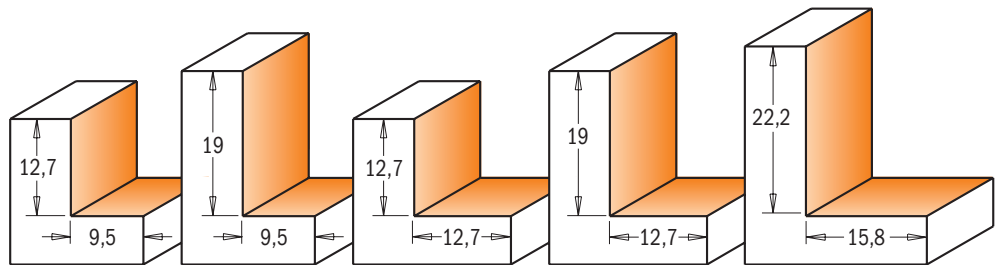

Drawings are 1:1 scale

H mm	D mm	I mm	L mm	Box	ORDER NO. S=Ø6mm	ORDER NO. S=Ø6,35mm	ORDER NO. S=Ø8mm	ORDER NO. S=Ø12mm	ORDER NO. S=Ø12,7mm	Spare parts					
9,5	31,7	12,7	58,4	10	735.317.11	835.317.11	935.317.11						990.423.00	791.003.00	990.058.00
9,5	31,7	12,7	61,2	10				935.817.11	835.817.11				990.423.00	791.003.00	990.058.00
9,5	31,7	19	64,8	10	735.318.11		935.318.11						990.423.00	791.003.00	990.058.00
12,7	34,9	12,7	59,4	10	735.350.11	835.350.11	935.350.11	935.850.11	835.850.11				990.422.00	791.002.00	990.058.00
12,7	34,9	19	65,8	10				935.851.11	835.851.11				990.422.00	791.002.00	990.058.00
15,8	50,8	22,2	77,8	10				935.990.11	835.990.11				990.408.00	791.010.00	990.058.00

**Spare parts**

991.057.00	3/32" hex key	541.514.00	2mm spacer (8/935.990.11)
799.503.00	19,05mm bushings		



# Rabbeting Bits with Insert Knives

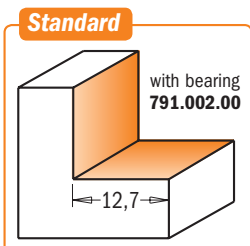

**660**

Rabbeting bits with two replaceable knives fixed by special Torx screws. The knives are sharpened on all 4 sides and increase efficiency when working with board materials. Rabbeting bits are equipped with ball bearing guides for rabbeting width H= 12,7mm. For chipboards, hardwood or MDF; for use on portable routers.

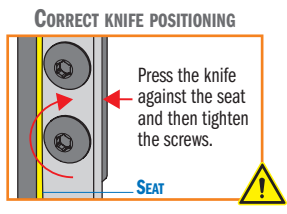

**791.703.00**

**Optional**



With this kit **791.703.00** you can obtain all cutting depth below.

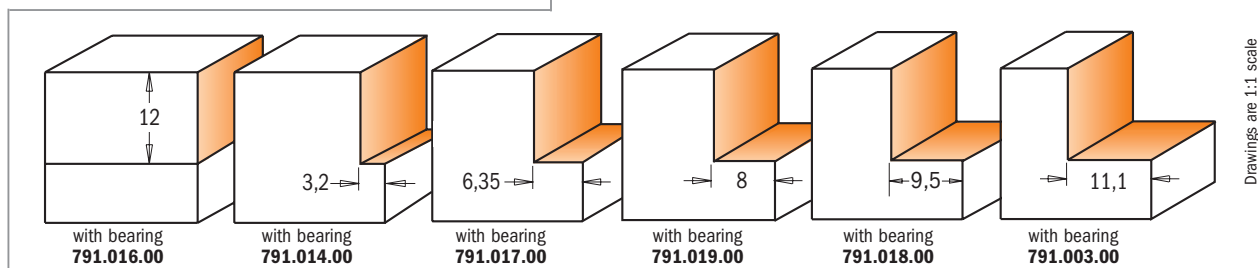

H mm	D mm	I mm	L mm	Box	ORDER NO. S=Ø6,35mm	ORDER NO. S=Ø8mm	ORDER NO. S=Ø12,7mm	Spare parts		
12,7	34,9	12	55	10	<b>660.351.11</b>	<b>660.350.11</b>				
12,7	34,9	12	65	10			<b>660.851.11</b>	790.120.00	990.075.00	991.061.00
<b>Spare parts</b>		791.002.00	Ø4,76/Ø9,5mm bearing	990.422.00	Ø4,76/Ø9,5mm shield	990.058.00	1/8"x3/8"x1/2" TCEI screw	990.057.00	3/32" hex key	

# Rabbeting Sets

**7/8/935.001**



CMT rabbeting sets allow you to make a limitless number of cuts by adjusting the cutting height on your router and changing the bearing on the bit. Every kit includes one rabbeting bit, 6 interchangeable ball bearing guides, fastening screws, shields, and an Allen Key. In order to change cutting depth, substitute the bearing.



**791.703.00**



**BE SURE** to keep the black bearing washer right side up to correspond with the bearing rotation when re-assembling the bearing. Improper re-assembly can cause the screw to come loose. Each set comes complete with one rabbeting bit and 6 interchangeable ball bearing guides.

Drawings are 1:1 scale

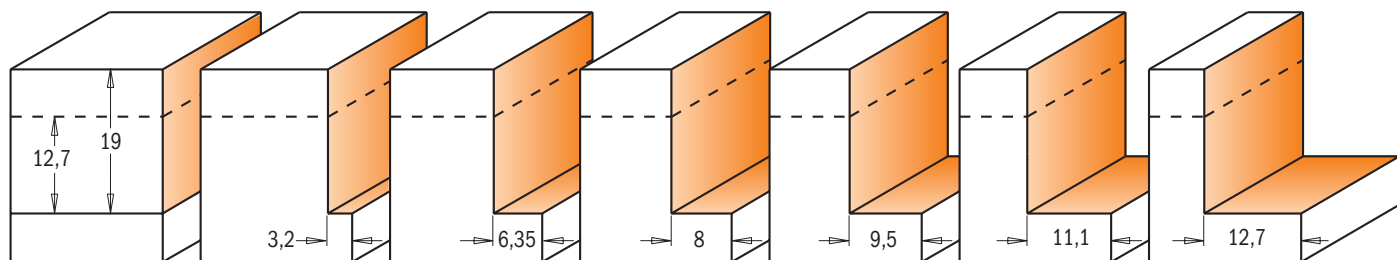

H mm	D mm	I mm	Box	ORDER NO. S=Ø6mm	ORDER NO. S=Ø6,35mm	ORDER NO. S=Ø8mm	ORDER NO. S=Ø12mm	ORDER NO. S=Ø12,7mm	
0-12,7	34,9	12,7	5	<b>735.001.11</b>	<b>835.001.11</b>	<b>935.001.11</b>	<b>935.501.11</b>	<b>835.501.11</b>	
0-12,7	34,9	19	5				<b>935.502.11</b>	<b>835.502.11</b>	
<b>Spare parts</b>		791.002.00	Ø4,76/Ø9,5mm bearing	990.422.00	Ø4,76/Ø9,5mm shield	990.058.00	1/8"x3/8"x1/2" TCEI screw	990.057.00	3/32" hex key

# Keyhole Bits

HW Z1 Z2 RH

## 7/8/950.0

With the CMT keyhole bit you can make holes that keep your frames, plaques or any wall hanging perfectly straight and attached to the wall. The perfect way to securely mount wall hangings on screws and nails. Three new bits available to create slots for M5, M6, M8 hexagonal head bolt for removable joints.

**SAFETY TIPS:** Be sure the workpiece is securely fastened to the router table or work bench.

**SHOP TIPS:** Recommended for use with a plunge router.

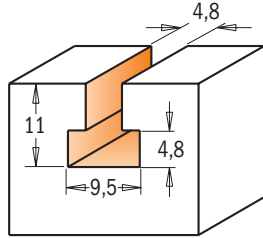

7/8/950.001.11

Drawing is 1:1 scale

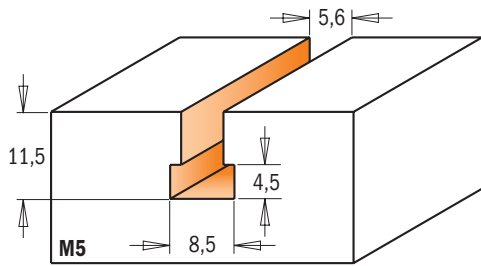
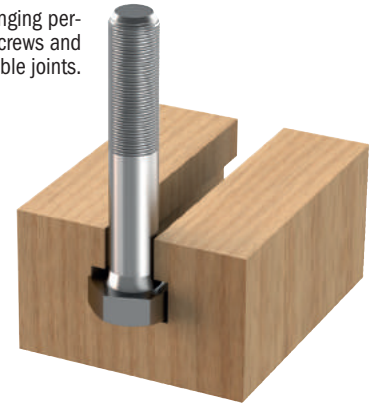

950.002.11

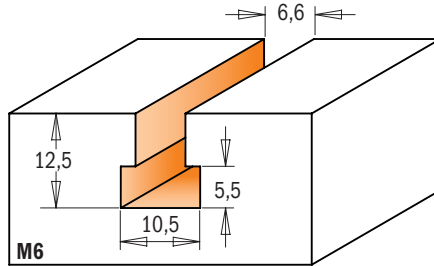

950.003.11

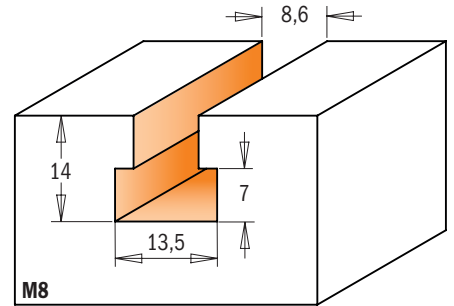

950.004.11

	D mm	d mm	I mm	L mm	Z			ORDER NO. S=Ø6mm	ORDER NO. S=Ø6,35mm	ORDER NO. S=Ø8mm	ORDER NO. S=Ø12mm	ORDER NO. S=Ø12,7mm
	8,5	5,6	11,5	47	1	M5	10			<b>950.002.11</b>		
	9,5	4,8	11	54	2		10	<b>750.001.11</b>	<b>850.001.11</b>	<b>950.001.11</b>	<b>950.501.11</b>	<b>850.501.11</b>
	10,5	6,6	12,5	48	1	M6	10			<b>950.003.11</b>		
	13,5	8,6	14	49	1	M8	10			<b>950.004.11</b>		

# T-Slot Bits

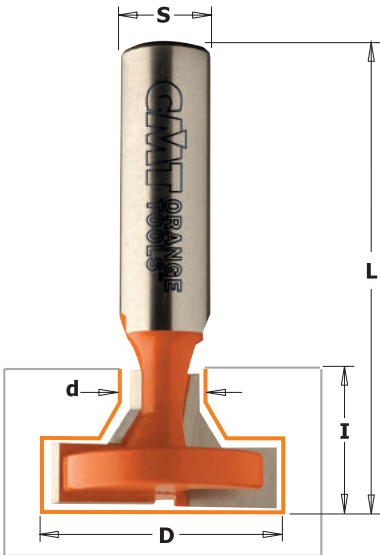

Drawings are 1:1 scale

## 8/950.6

HW Z2 Z1+1 RH

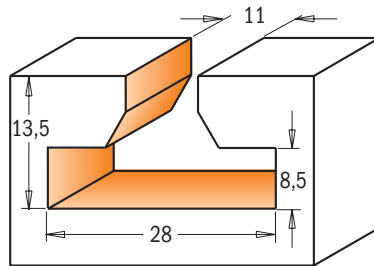

8/950.603

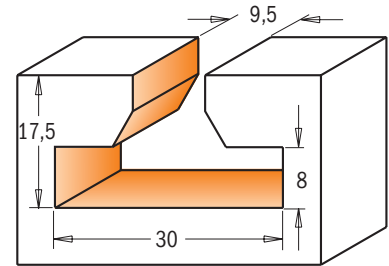

8/950.601

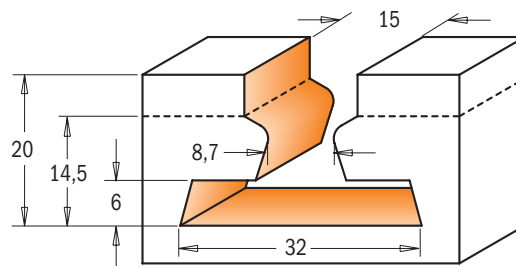

950.604

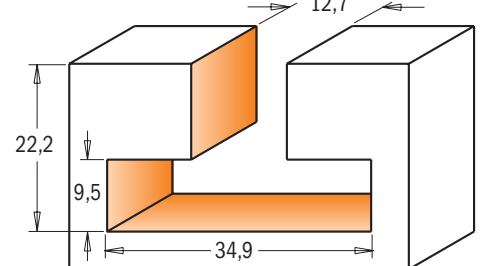

8/950.602

	D mm	d mm	I mm	L mm	Z		ORDER NO. S=Ø12mm	ORDER NO. S=Ø12,7mm
	28	11	13,5	56,3	2	10	<b>950.603.11</b>	<b>850.603.11</b>
	30	9,5	17,5	60,3	2	10	<b>950.601.11</b>	<b>850.601.11</b>
	32	8,7-15	20	66	1+1	10	<b>950.604.11</b>	
	34,9	12,7	22,2	63,5	2	10	<b>950.602.11</b>	<b>850.602.11</b>

**HW Z2 RH**

## 8/913

Any large panel or table top should be secured in a way that allows it to expand or contract without splitting. These screw-slot bits let you create screw slots so that panels can be held in place but are able to slide back and forth without splitting the wood or breaking the screw securing them.

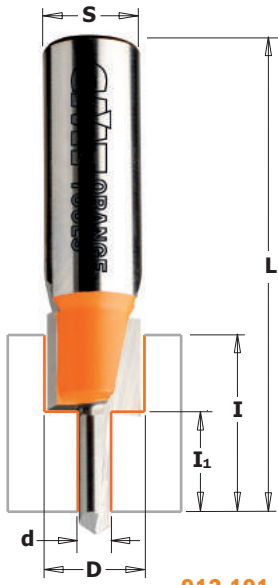

**913.101.11**  
**813.601.11**

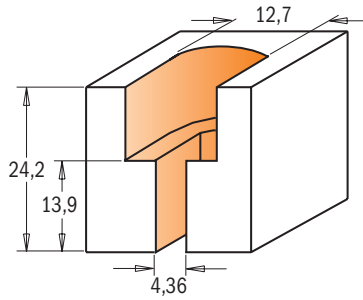

Drawing is 1:1 scale

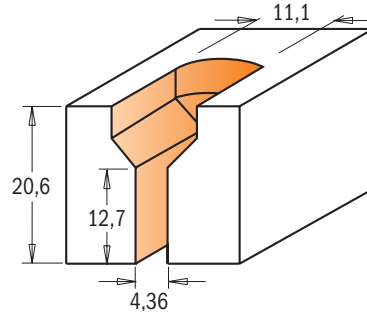

**913.201.11**  
**813.701.11**

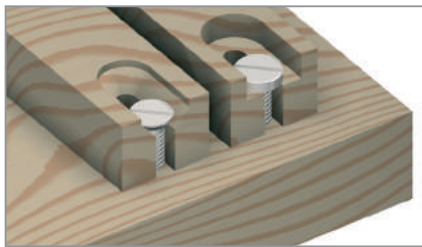

D mm	d mm	I <sub>1</sub> mm	I mm	L mm		ORDER NO. S=Ø8mm	ORDER NO. S=Ø12,7mm
11,1	4,36	12,7	20,6	63,5	10	<b>913.201.11</b>	<b>813.701.11</b>
12,7	4,36	13,9	24,2	63,5	10	<b>913.101.11</b>	<b>813.601.11</b>

# Flooring Router Bits

## 822.023B - 822.024B

**HW Z2 RH**

CMT now offers these industrial quality carbide-tipped router bits for flooring and inlay applications. They easily and smoothly run through solid and timber wood while cutting edges and remain sharp even after several passes. 822.024.11B item number also features rounded edges to produce 3,2mm (1/8") radius inlays. These bits are equipped with a stop collar and a bearing.

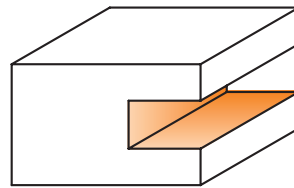
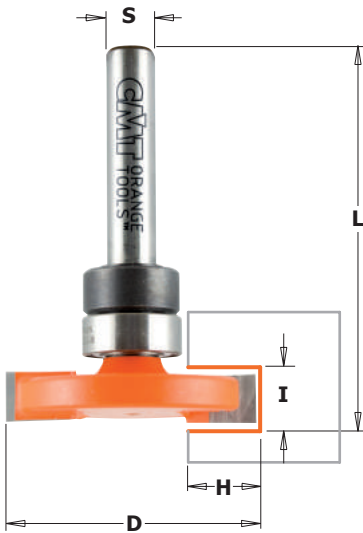

**822.023.11B**

Drawings are 1:1 scale

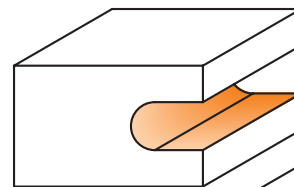

**822.024.11B**

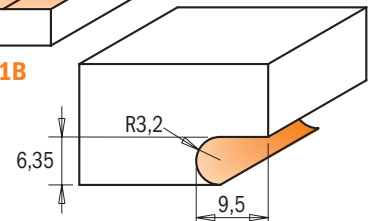

D mm	I mm	H mm	R mm	L mm		ORDER NO. S=Ø6,35mm	Spare parts			
31,75	6,35	9,5		47,6	10	<b>822.023.11B</b>				
31,75	6,35	9,5	3,2	47,6	10	<b>822.024.11B</b>	791.010.00	541.001.00	990.005.00	991.056.00
							791.010.00	541.001.00	990.005.00	991.056.00



# Three Wing Slot Cutter Set

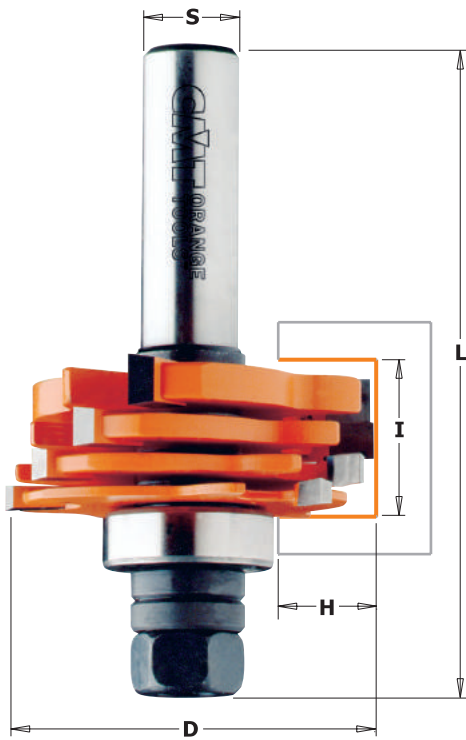

## 8/900.506

Create slots, grooves and rabbets in materials from 3,2mm to 18mm in depth by using the adjustable CMT Three Wing slot cutter set. See chart below for details on spacing and correct cutter combinations. Ideal for biscuit joints and milling perfect tongue and groove joints.

- This set includes:
- 4 carbide tipped cutters 3,2mm, 4mm, 4,8mm, 6,4mm
  - 1 arbor 12mm or 12,7mm
  - 1 ball bearing (22mm) for 12,7mm cut
  - 17 shims: (8x0,1mm - 4x0,5mm - 3x1mm and 2x4mm)

**SAFETY TIPS:** never use the slot cutter set without shims between the cutters.

The distance between the cutters can vary from 1mm to 1,7mm. A shim must also be positioned between the ball bearing and the cutters.

**SHOP TIPS:** the bearings kit 791.711.00 makes 6,35mm and 9,5mm cutting depths.

**NOTE:** The carbide edges of the cutters should never touch; arrange the shims as illustrated below. Use only the thicknesses provided in the set. Be sure all cutters are assembled in the proper right rotational direction below. Looking down the arbor the cutters will turn clockwise.

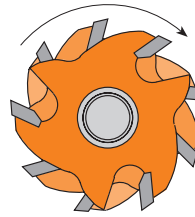

Cutter combinations	Cutter height	
	mm	mm
A	3,2	
B	4	
C	4,8	
D	6,4	
A + B	6,4	a 7,1
A + C	7,2	a 7,9
A + D	8,8	a 9,5
B + C	8	a 8,7
B + D	9,6	a 10,3
C + D	10,4	a 11,1
A + B + C	10,4	a 11,8
A + B + D	11,9	a 13,3
A + C + D	12,7	a 14,1
B + C + D	13,5	a 14,9
A + B + C + D	15,9	a 18

Use shims to adjust cut width: MIN.1mm - MAX 1,7mm

I mm	D mm	H mm	L mm		ORDER NO. S=Ø12mm	ORDER NO. S=Ø12,7mm	Spare parts
3,2-18	47,6	12,8	81	10	<b>900.506.11</b>		924.128.00 791.005.00 990.020.00
3,2-18	47,6	12,8	81	10		<b>800.506.11</b>	824.128.00 791.005.00 990.020.00

Spare parts	Optional
541.515.00 0,1mm spacer	791.711.00 Kit with two 28,5mm and 34,9mm bearing for slot cutter
541.517.00 0,5mm spacer	
541.518.00 1mm spacer	
541.501.00 4mm spacer	

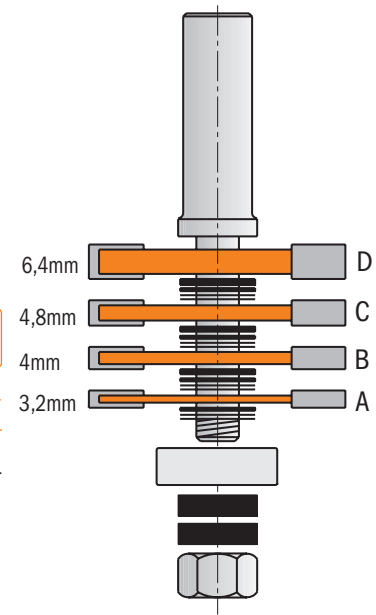

# Tongue & Groove Set

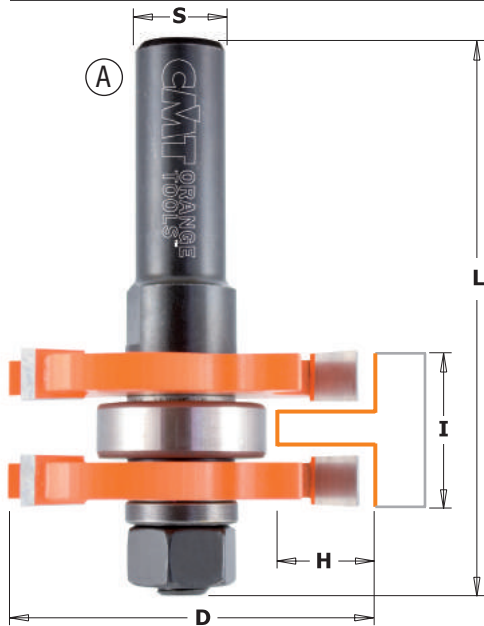

## 8/900.626

Make tongue and groove joints without the complicated process of taking apart and reassembling bits. The new CMT tongue and groove set gives you one bit to groove the slot and a separate bit to mill the tongue. Or use your imagination and put them to work individually on other projects. Makes tongue and groove cuts in wood up to 19mm thickness.

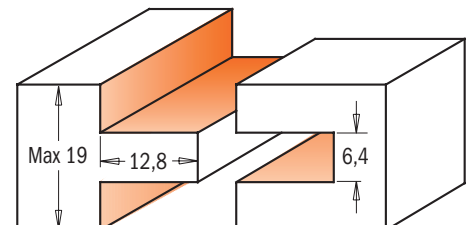

Drawings are 1:1 scale

PROFILE	I mm	D mm	H mm	L mm		ORDER NO. S=Ø8mm	ORDER NO. S=Ø12mm	ORDER NO. S=Ø12,7mm
A+B	19	47,6	12,8	71	5	<b>900.126.11</b>		
A+B	19	47,6	12,8	71	5		<b>900.626.11</b>	
A+B	19	47,6	12,8	71	5			<b>800.626.11</b>
A	19	47,6	12,8	71	10			<b>800.626.11M</b>

Spare parts
924.083.00 791.005.00 822.364.11 990.020.00
924.131.00 791.005.00 822.364.11 990.020.00
824.131.00 791.005.00 822.364.11 990.020.00
824.131.00 791.005.00 822.364.11 990.020.00

Spare parts	Optional
541.515.00 0,1mm spacer	541.518.00 1mm spacer
541.516.00 0,3mm spacer	541.500.00 3mm spacer
541.517.00 0,5mm spacer	



## 7/8/922A/B

Uses for the CMT three wing slot cutter are almost infinite. Cut slots and grooves for splines, biscuits, T-molding or tongue and groove joints.  
 Every cutter features anti-kickback design, micrograin carbide tips and CMT's trademark orange non-stick PTFE coating. CMT slot cutters are available as a blade only or with your choice of a 6, 8, 12, 6,35 or 12,7mm diameter arbor which includes a 22mm diameter bearing for a cutting depth of up to 12,7mm.

**NOTE:** For biscuit joints, use l=4mm slot cutter.

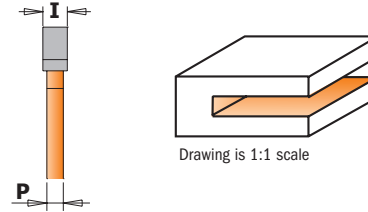
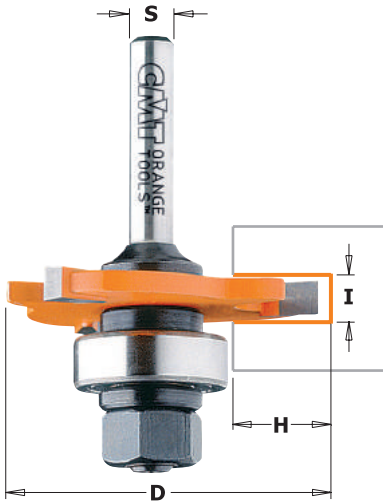

I mm	P mm	D mm	H mm		ORDER NO. S=Ø6mm	ORDER NO. S=Ø6,35mm	ORDER NO. S=Ø8mm	ORDER NO. S=Ø12mm	ORDER NO. S=Ø12,7mm
1,5	1,07	47,6	12,8	10	<b>722.315.11A</b>		<b>922.315.11A</b>	<b>922.315.11B</b>	
1,6	1,07	47,6	12,8	10		<b>822.316.11A</b>			<b>822.316.11B</b>
2	1,27	47,6	12,8	10	<b>722.320.11A</b>	<b>822.320.11A</b>	<b>922.320.11A</b>	<b>922.320.11B</b>	<b>822.320.11B</b>
2,4	1,27	47,6	12,8	10		<b>822.324.11A</b>			<b>822.324.11B</b>
2,5	1,27	47,6	12,8	10	<b>722.325.11A</b>		<b>922.325.11A</b>	<b>922.325.11B</b>	
3	1,27	47,6	12,8	10	<b>722.330.11A</b>		<b>922.330.11A</b>	<b>922.330.11B</b>	
3,2	1,27	47,6	12,8	10		<b>822.332.11A</b>			<b>822.332.11B</b>
3,5	2,07	47,6	12,8	10	<b>722.335.11A</b>		<b>922.335.11A</b>	<b>922.335.11B</b>	
4	2,07	47,6	12,8	10	<b>722.340.11A</b>	<b>822.340.11A</b>	<b>922.340.11A</b>	<b>922.340.11B</b>	<b>822.340.11B</b>
4,8	2,86	47,6	12,8	10		<b>822.348.11A</b>			<b>822.348.11B</b>
5	2,86	47,6	12,8	10	<b>722.350.11A</b>		<b>922.350.11A</b>	<b>922.350.11B</b>	
6	4,45	47,6	12,8	10	<b>722.360.11A</b>	<b>822.360.11A</b>	<b>922.360.11A</b>	<b>922.360.11B</b>	<b>822.360.11B</b>
6,4	4,45	47,6	12,8	10		<b>822.364.11A</b>			<b>822.364.11B</b>

These three wing carbide tipped Slot Cutters feature anti-kickback three wing blade design and CMT's trademark orange P.T.F.E. Industrial Coating. All cutters feature an 8mm bore that fits CMT's arbors (items 7/8/924).

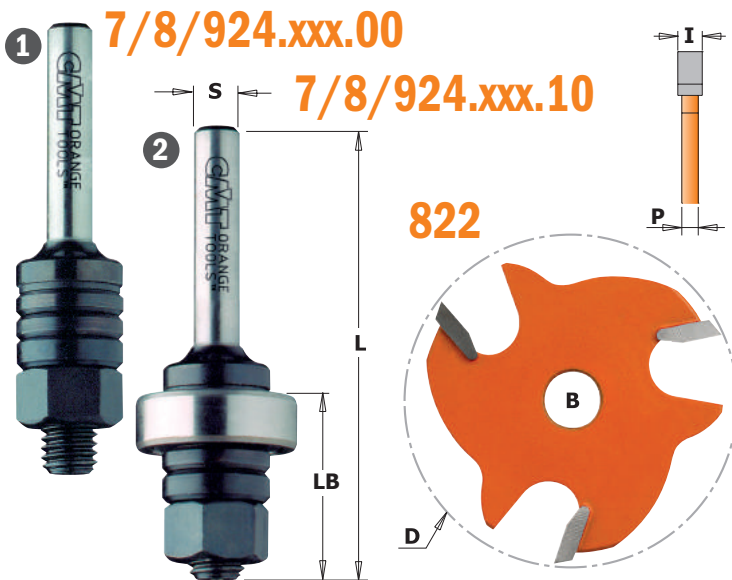

I mm	P mm	D mm	B mm		ORDER NO.
1,5	1,07	47,6	8	10	<b>822.315.11</b>
1,6	1,07	47,6	8	10	<b>822.316.11</b>
1,8	1,27	47,6	8	10	<b>822.318.11</b>
2	1,27	47,6	8	10	<b>822.320.11</b>
2,2	1,27	47,6	8	10	<b>822.322.11</b>
2,4	1,27	47,6	8	10	<b>822.324.11</b>
2,5	1,27	47,6	8	10	<b>822.325.11</b>
2,8	1,27	47,6	8	10	<b>822.328.11</b>
3	1,27	47,6	8	10	<b>822.330.11</b>
3,2	1,27	47,6	8	10	<b>822.332.11</b>
3,5	2,07	47,6	8	10	<b>822.335.11</b>
4	2,07	47,6	8	10	<b>822.340.11</b>
4,8	2,86	47,6	8	10	<b>822.348.11</b>
5	2,86	47,6	8	10	<b>822.350.11</b>
6	4,45	47,6	8	10	<b>822.360.11</b>
6,4	4,45	47,6	8	10	<b>822.364.11</b>

DESCRIPTION	LB mm	L mm		ORDER NO. S=Ø6mm	ORDER NO. S=Ø6,35mm	ORDER NO. S=Ø8mm	ORDER NO. S=Ø12mm	ORDER NO. S=Ø12,7mm
1 Slot cutter arbor without bearing	26	61	10	<b>724.060.00</b>	<b>824.064.00</b>	<b>924.080.00</b>		
1 Slot cutter arbor without bearing	26	67,5	10				<b>924.120.00</b>	<b>824.127.00</b>
1 Slot cutter arbor with bearing	26	61	10	<b>724.060.10</b>	<b>824.064.10</b>	<b>924.080.10</b>		
2 Slot cutter arbor with bearing	26	67,5	10				<b>924.120.10</b>	<b>824.127.10</b>
Slot cutter arbor without bearing, long series	40	86	10			<b>924.083.00</b>		
Slot cutter arbor with bearing, long series	40	86	10			<b>924.083.10</b>		
<b>Spare parts</b>	<b>791.005.00</b>	Ø8-22mm bearing		<b>541.518.00</b>	1mm spacer			
	<b>541.501.00</b>	4mm spacer		<b>990.020.00</b>	M8 nut			
	<b>541.500.00</b>	3mm spacer						

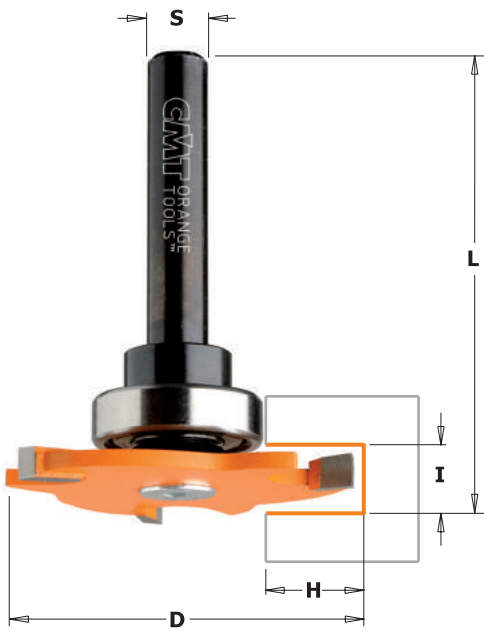

## 923A - 823B

The uses of this bit are infinite: not only can you rout grooves and rabbets, but you can even T or dovetail joints on wood panels. Each bit features three carbide-tipped cutters, orange coloured PTFE coating and anti-kickback design. The 22mm bearing is included for a cutting depth of 12,8mm. The bit and the slot cutter are also available separately.

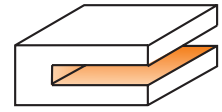
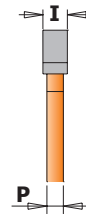

Drawing is 1:1 scale

I mm	P mm	D mm	H mm	L mm		ORDER NO. S=Ø8mm	ORDER NO. S=Ø12,7mm
3	1,27	47,6	12,8	58	10	<b>923.330.11A</b>	
3,2	1,27	47,6	12,8	57,5	10		<b>823.332.11B</b>
4	2,07	47,6	12,8	58,3	10	<b>923.340.11A</b>	<b>823.340.11B</b>
5	2,86	47,6	12,8	63	10	<b>923.350.11A</b>	
6,4	4,45	47,6	12,8	60,7	10		<b>823.364.11B</b>

## 823

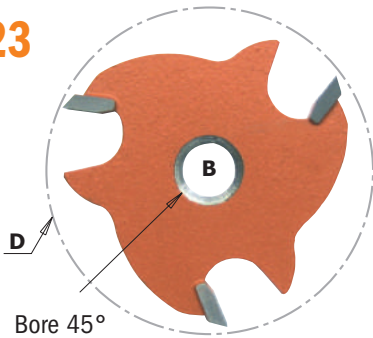

Bore 45°

These three wing carbide tipped slot cutters feature anti-kickback three wing blade design and CMT's trademark orange PTFE Industrial Coating. All cutters feature an 8mm bore that fits CMT's arbors (items 7/8/924).

I mm	P mm	D mm	B mm		ORDER NO.
3	1,27	47,6	8	10	<b>823.330.11</b>
3,2	1,27	47,6	8	10	<b>823.332.11</b>
4	2,07	47,6	8	10	<b>823.340.11</b>
5	2,86	47,6	8	10	<b>823.350.11</b>
6,4	4,45	47,6	8	10	<b>823.364.11</b>

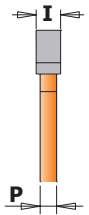

## 7/8/924



with stop collar



## 8/924

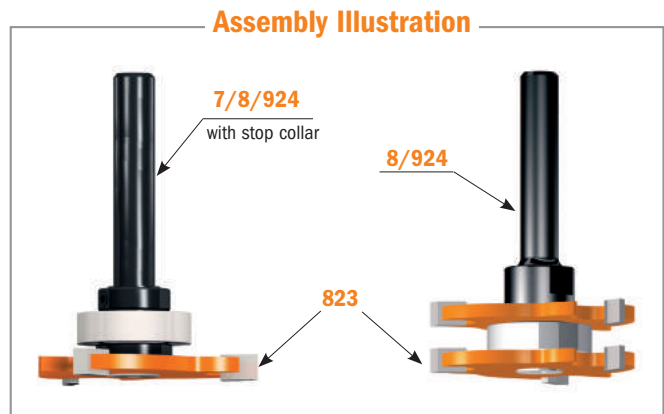

DESCRIPTION		ORDER NO. S=Ø6mm	ORDER NO. S=Ø6,35mm	ORDER NO. S=Ø8mm	ORDER NO. S=Ø12,7mm
① Slot cutter arbor without bearing without stop collar	10	<b>724.061.00</b>	<b>824.061.00</b>	<b>924.081.00</b>	<b>824.121.00</b>
① Slot cutter arbor with bearing and stop collar	10	<b>724.061.10</b>	<b>824.061.10</b>	<b>924.081.10</b>	<b>824.121.10</b>
② Slot cutter arbor without bearing	10			<b>924.082.00</b>	<b>824.122.00</b>
② Slot cutter arbor with bearing	10			<b>924.082.10</b>	<b>824.122.10</b>

Spare parts	791.012.00	541.001.00	541.002.00	791.013.00	541.003.00	541.004.00	541.515.00	541.516.00	541.517.00	541.518.00	990.055.00	991.067.00
	Ø8-22mm bearing	Stop collar for Ø6,35mm shanks	Stop collar for Ø12,7mm shanks	Ø12,7-22mm bearing	Stop collar for Ø6mm shanks	Stop collar for Ø8mm shanks	0,1mm spacer	0,3mm spacer	0,5mm spacer	1mm spacer	M5x12mm TSP/PEI screw	3mm hex key



Flute & Bead Set



**8/955.701**

This perfectly mated CMT set is ideal for making canoe slats and hot tub enclosures. The cutting edges feature tungsten carbide which stay sharp even after cutting large amounts of stock. The anti-kickback design ensures that you work safely.

Use both the flute and the bead bits for 6,35mm (1/4") slats as shown below.

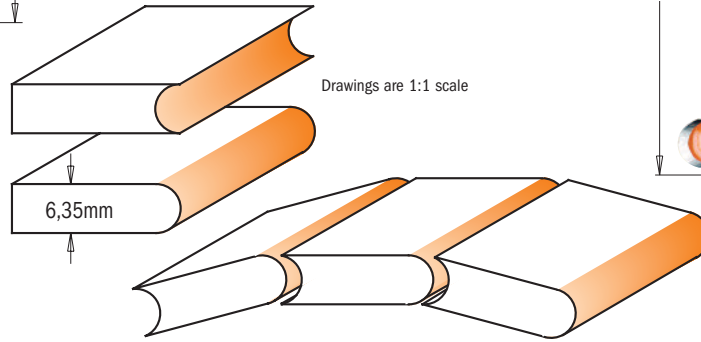
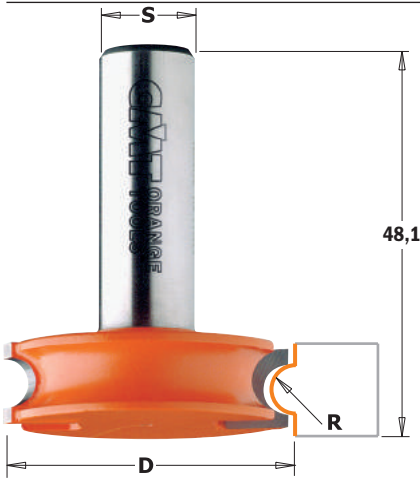

<b>R</b> mm	<b>D</b> mm						<b>ORDER NO.</b> S=Ø12mm	<b>ORDER NO.</b> S=Ø12,7mm
3,2	38					5	<b>955.701.11</b>	<b>855.701.11</b>

Lock Miter Set



**8/955**

Now you don't have to fight with those awkward clamps on your 22.5° angle projects. Use this pair of bits to produce octagonal shaped boxes and popular corner cabinetry like cabinets for kitchens, entertainment centres, kitchen islands and corner hutches. This 22.5° Lock Miter set provides a strong tight joint even at 45° angles.

Biscuits and splines are time consuming and difficult to clamp; but CMT's matched cutters make set-up easy. Height adjustment is not an issue. All you have to do is adjust your fence so the top edge of the workpiece intersects the angle of the bit where it meets the fence.

After your joints are machined they can be glued and assembled and simply clamped by using strapping tape.

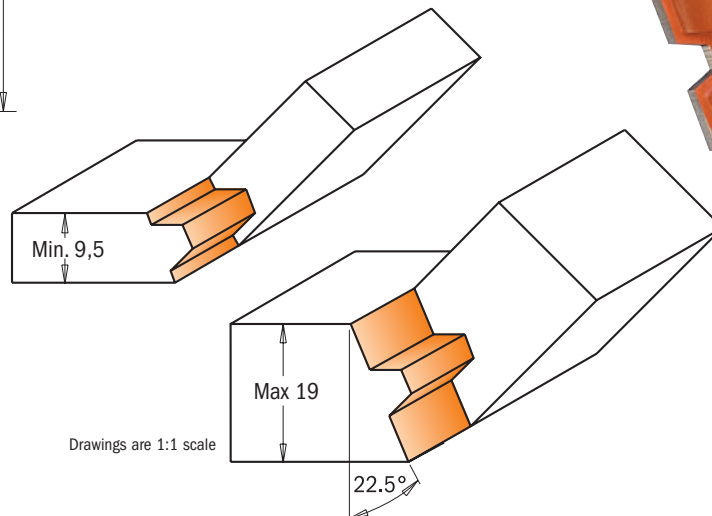
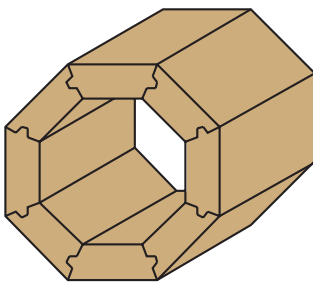
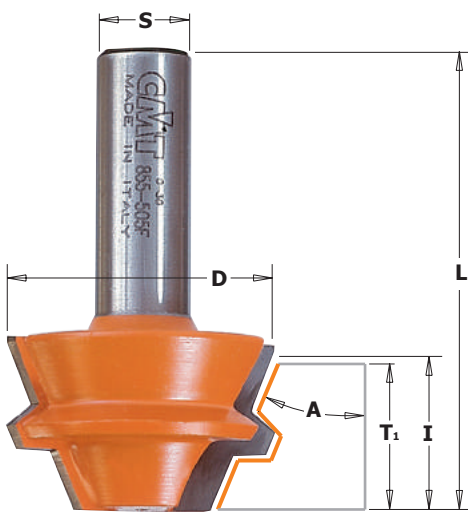

<b>D</b> mm	<b>I</b> mm	<b>A</b>	<b>T<sub>1</sub></b> mm	<b>L</b> mm			<b>ORDER NO.</b> S=Ø8mm	<b>ORDER NO.</b> S=Ø12,7mm
37,3	22,2	22,5°	9,5 ÷ 19	60,3		5	<b>955.005.11</b>	<b>855.505.11</b>



CMT lock miter bits are ideal for milling miter joints in 28,5mm stock. A quick and easy way to accurately create boxes, stretcher bars, frames and any assortment of right angle or parallel joint projects.

**To produce perfectly fitting miter joints**, lay one piece with the inside face-down on the work table and the wood centred to the bit. Mill as shown in step 1 of the illustration below. Mill the second piece with the inside face placed vertical to the bit and fence, as shown in step 2.

**To mill sturdy parallel glue joints** follow step 1 shown in the illustration with the inside face of the workpiece laid flat on the table and centred to the bit. To make the second part, lay the workpiece flat on the table and centred to the bit. Mill with the inside face-up.

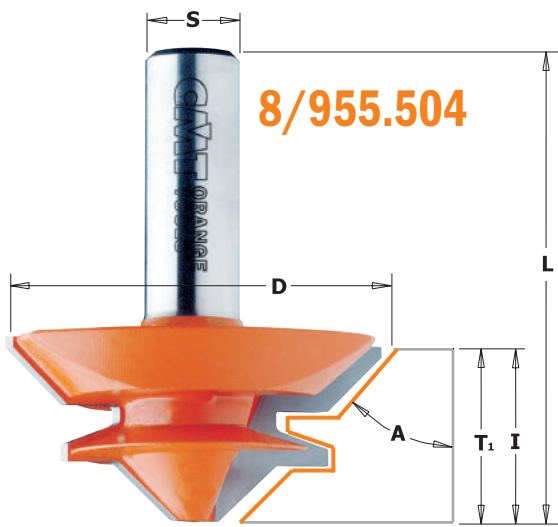

8/955.504

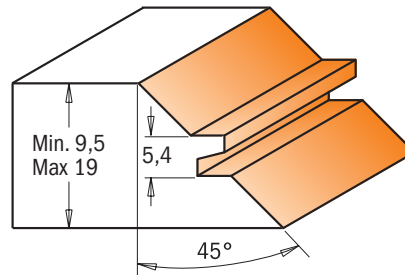

8/955.503

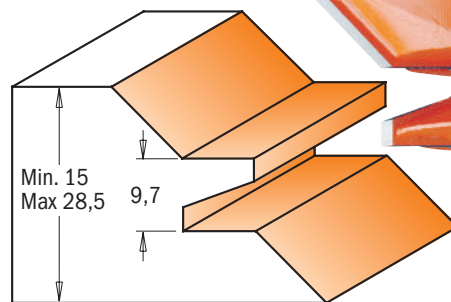

Drawings are 1:1 scale

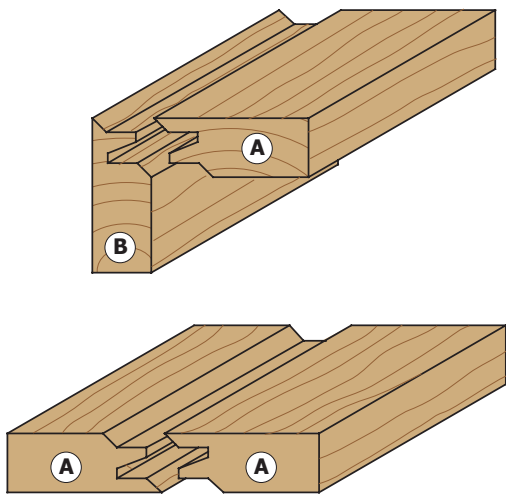

## For miter and parallel glue joints using 19mm board

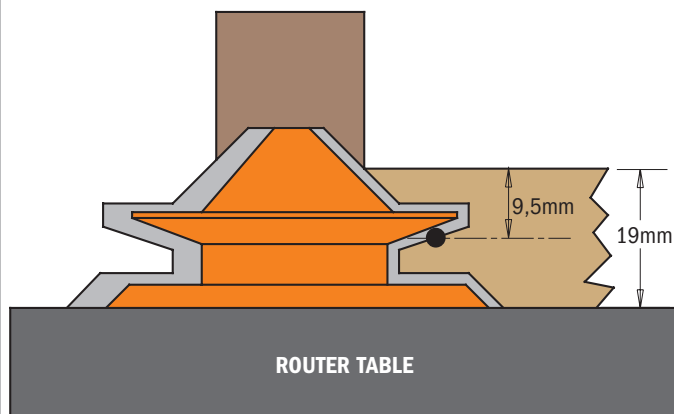

**Nr. 1:** Rout one piece with the inside face flat on the router table. Be sure the cut is centred to the stock.

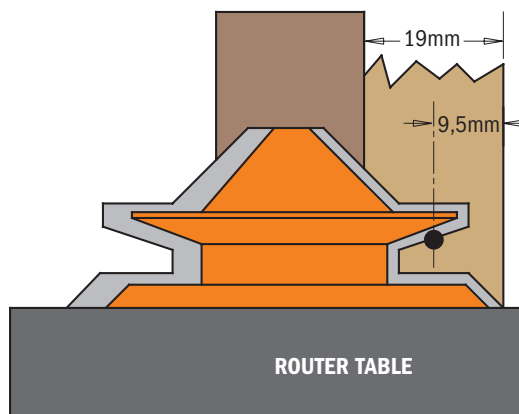

**Nr. 2:** Rout the second piece with the inside face vertical to the fence.

D mm	I mm	A	T <sub>1</sub> mm	L mm		ORDER NO. S=Ø8mm	ORDER NO. S=Ø12mm	ORDER NO. S=Ø12,7mm
44,5	18	45°	9 ÷ 18	58	5	<b>955.009.11</b>		
70	31,7	45°	15 ÷ 28,5	69,9	5		<b>955.503.11</b>	<b>855.503.11</b>
50,8	22,2	45°	9,5 ÷ 19	60,3	5		<b>955.504.11</b>	<b>855.504.11</b>

new

Reverse Glue Joint Bits



**8/955.501**

The most unique and important characteristic of this CMT bit is its capacity to produce a virtually indestructible glue joint quickly and flawlessly. Ideal for routing panels, doors and furniture pieces of wide dimension panels, doors and furniture pieces. By accurately centering the bit to the wood, the upper and lower vertical cutting edges of the bit will cut equal proportions. Simply run one edge of the panel, turn the panel over, and then run the opposite edge - you will craft perfectly harmonized reverse cuts that match up to produce immaculate joints!

**SHOP TIPS:** When glueing, apply enough pressure to securely seal the joint. Insufficient pressure results in a weak joint and excessive pressure will distort the wood.

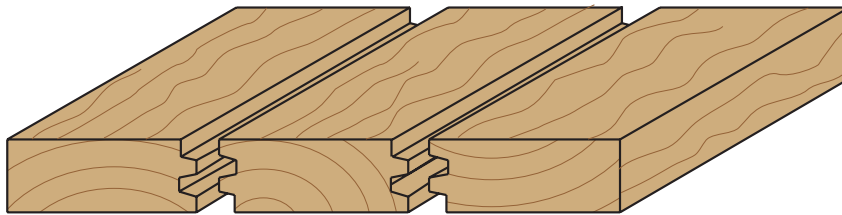
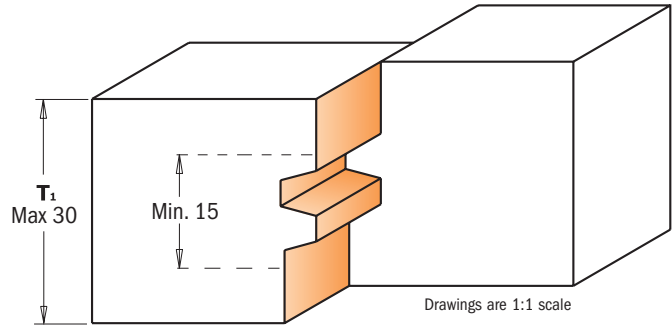
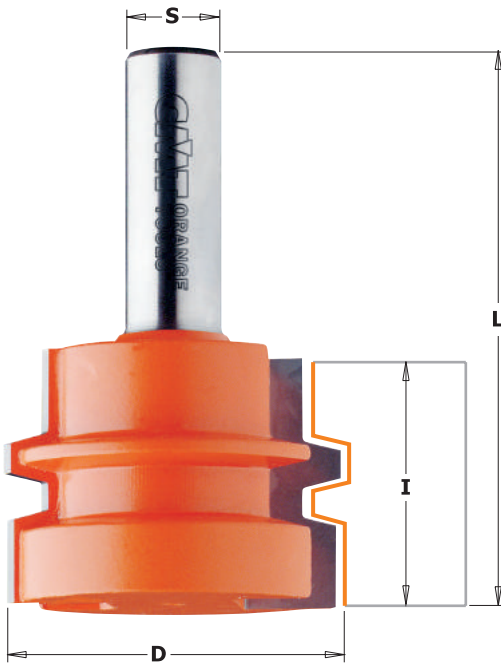

**Example using a 19mm board**

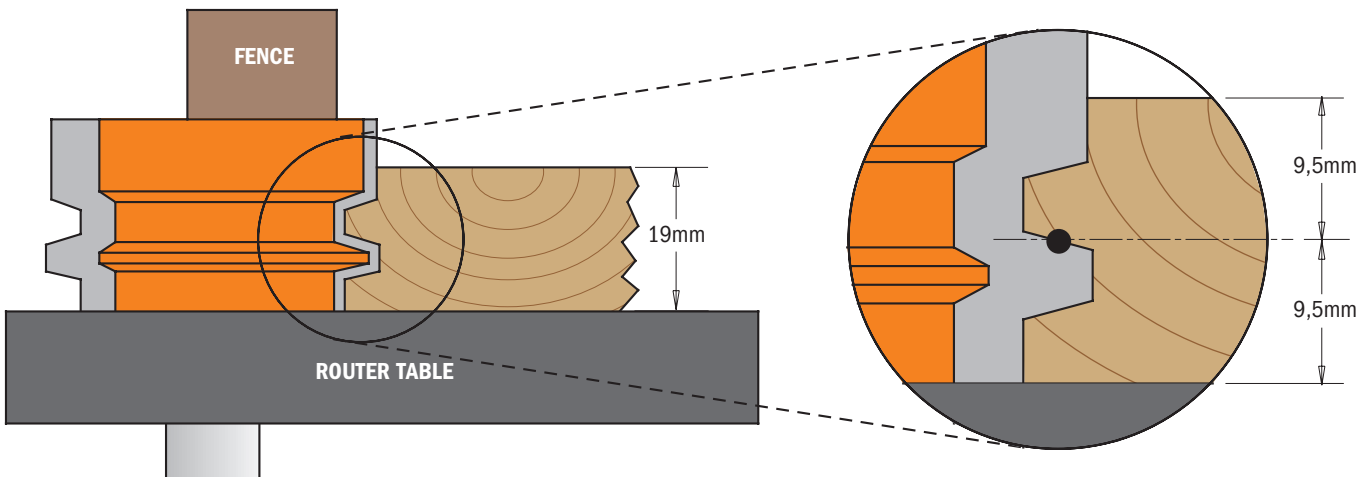

To accurately centre the wood to the bit: Adjust the bit according to the thickness of the wood you are cutting. Line up the cut edge of the wood to the centre point of the bit as illustrated in the enlarged drawing. The upper and lower vertical cutting edges of the bit are in proportion and at an equal distance from the centre point of the bit. Run one cut edge of the wood, turn the piece over and run the other edge for exact reverse cuts that match up perfectly. Assemble the reverse cut pairs together for beautiful, strong joints.

D mm	I mm	T <sub>1</sub> mm	L mm				ORDER NO. S=∅12mm	ORDER NO. S=∅12,7mm
44,4	32	15 - 30	70,1			10	<b>955.501.11</b>	<b>855.501.11</b>



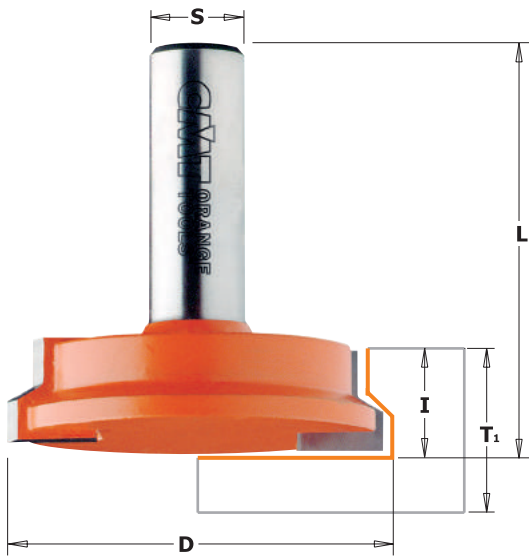

## 7/8/955



The key to success when constructing quality drawers is in the quality of the drawer lock bit you use. With CMT drawer lock bits you can make strong, perfectly fitted joints quickly and easily. As illustrated below, mill the drawer front with the inside face placed vertical to the bit and fence, and perpendicular to the table. These bits are to be used on router tables only. Do not use on hand-held routers.

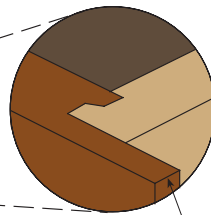
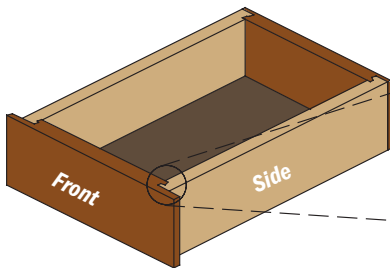
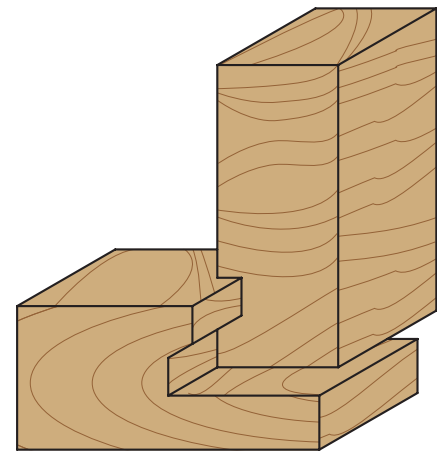
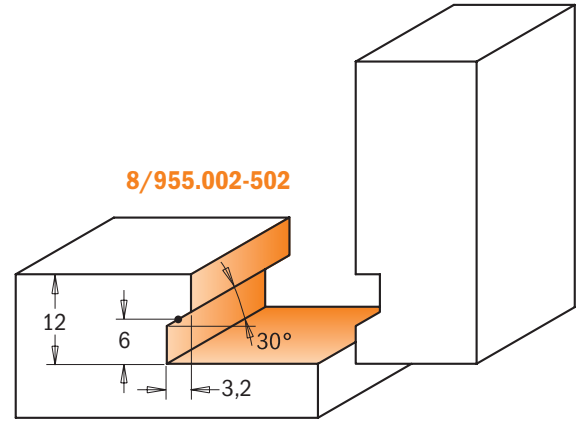
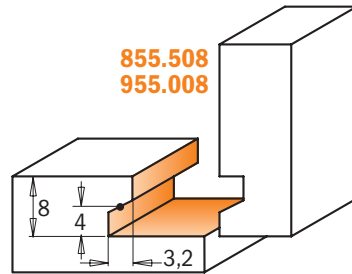
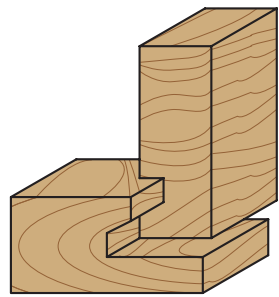

Overhang for drawer stop

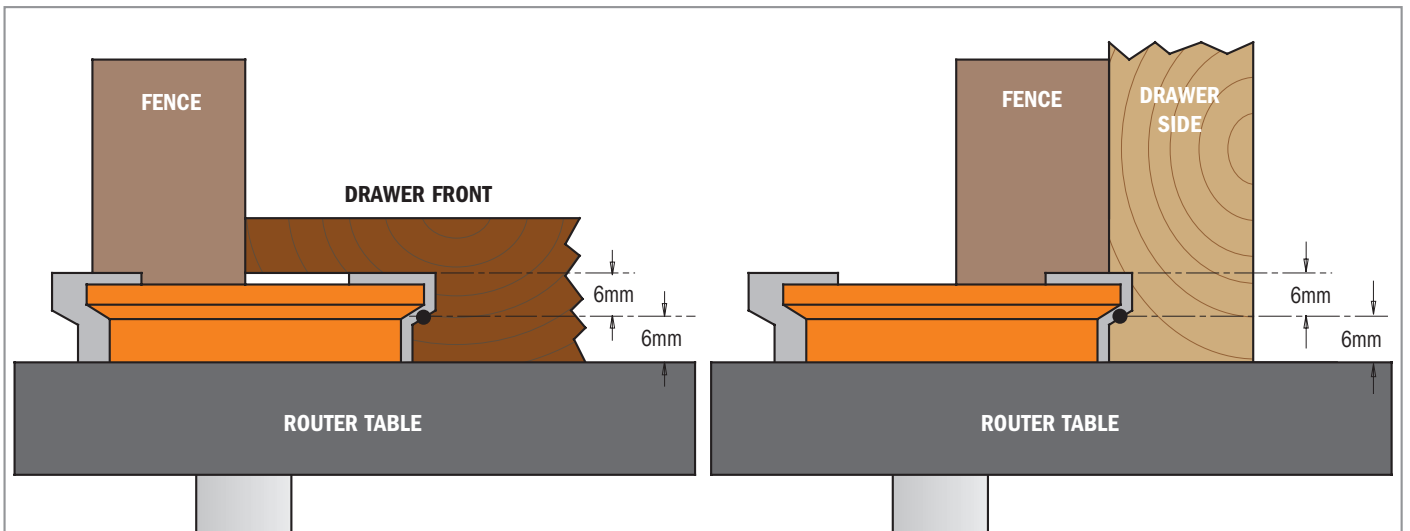

D mm	T <sub>1</sub>		I mm	L mm	Box	ORDER NO. S=Ø6mm	ORDER NO. S=Ø6,35mm	ORDER NO. S=Ø8mm	ORDER NO. S=Ø12mm	ORDER NO. S=Ø12,7mm
	min. mm	max. mm								
25,4	9,5	15,87	12,7	54	10			955.008.11		855.508.11
31,7	15,87	25,4	12,7	44,5	10	755.002.11	855.002.11	955.002.11		
50,8	15,87	25,4	12,7	50,8	10				955.502.11	855.502.11

# Window Sash Set



**8/955.801**

CMT designed this set so you can create window sashes that are as beautiful as they are functional. As an additional feature, the CMT window sash set will also mill perfectly matched 35mm rail and stile parts for custom made doors. Like all CMT quality bits, this set includes our anti-kickback design feature and our trademark non-stick orange coating. Made of Fatigue Proof® steel with carbide-faced cutting edges for longer life. Each set contains one 38mm bit and one 35mm bit designed for cutting 35mm stock.

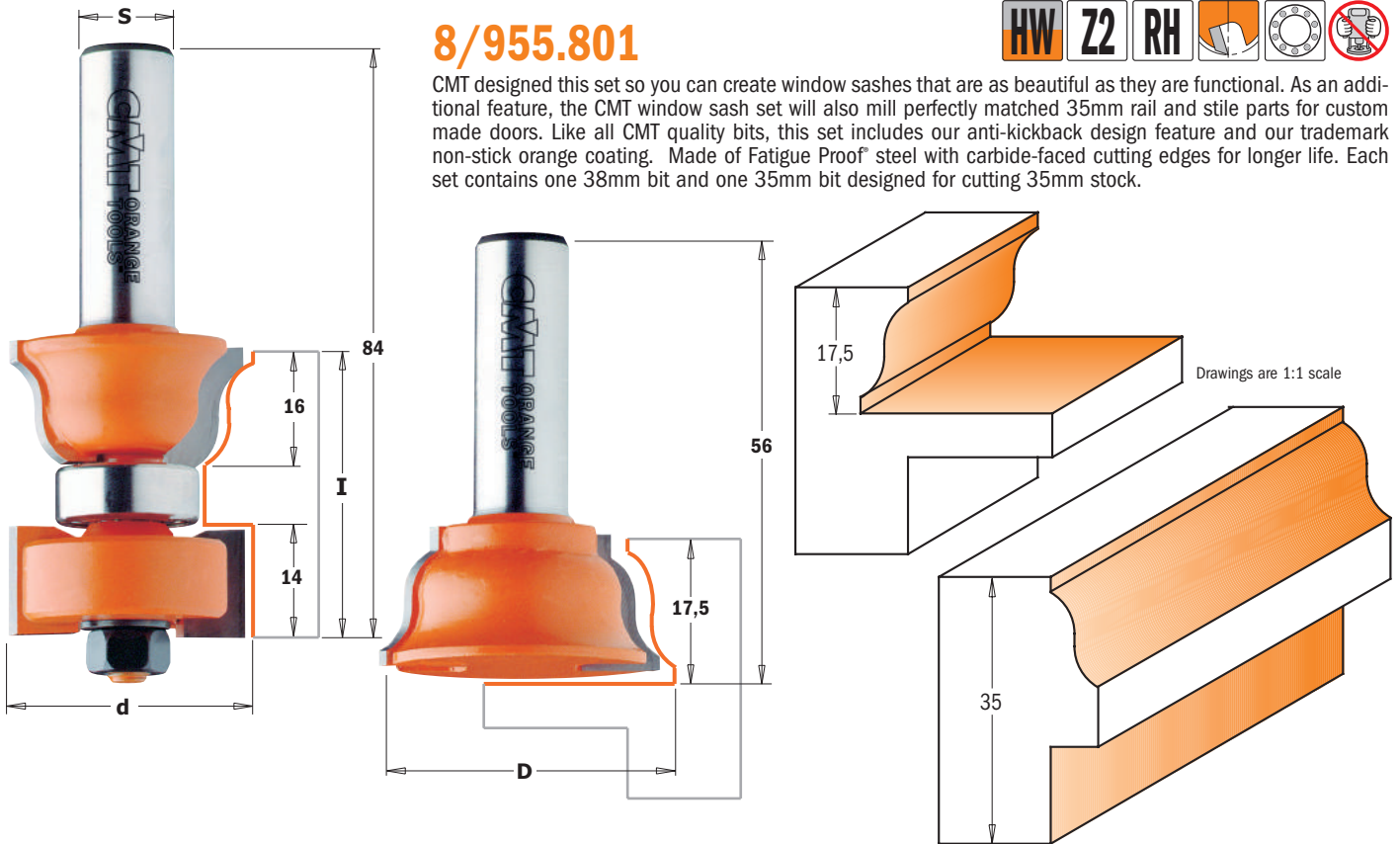

Drawings are 1:1 scale

d	l	L	D	l	L		ORDER NO.	ORDER NO.
mm	mm	mm	mm	mm	mm		S=Ø12mm	S=Ø12,7mm
35	35	84	38	17,5	56		<b>955.801.11</b>	<b>855.801.11</b>

Spare parts

791.012.00	822.004.11	541.518.00	990.020.00

## Step-By-Step Window Sash Construction

### CMT set makes it easy!

In our step-by-step example for window sash construction, we used the following:

- CMT Window Sash Set (item #855.801.11)
- stiles cut 35mm thick
- rails cut 35mm thick
- scrap stock

The CMT Window Sash Set was designed ideally for the construction of windows in 35mm stock, however variations as narrow as 28mm can be used. Stock thicker than 35mm exceeds the milling range of the cutter. Remember to adjust your measurements and cutting depths according to the wood thickness you use. We suggest making a trial joint in scrap stock according to the following steps before milling all of the cope and stick profiles.

#### STEP 1 - Measurements and making the tenons

The ideal thickness of the stiles when using the CMT sash set is 35mm. The desired width of the stiles will determine the length you need to make your tenons, while the length of the stile will represent the desired full height of the sash. When cutting the rails to length, make sure to add the length of the two tenons to the overall length of the rail. The length of the tenons should be at least half the width of the stile. Mill 16mm measuring from the front face of the stock using a table saw, radial saw or router as shown in illustration 1. This measurement remains invariable since it is calculated to the height of the CMT sash routers. The width of the tenon is 6mm. Rotate the stock and mill the other side. As per our example, the second milling will be 13mm but this measurement will vary if you are using thinner stock.

#### STEP 2 - Making the cope profile on rails, sash bar and muntins

To make the cope profile, place the rail face front down on the router table with the tenon flush to the bit as shown in illustration 2. Adjust the fence so the bit mills 6,35mm deeper than the tenon. To mill the sash bar and the muntins (cross bars), position front face down on the router table and mill without changing the height of the bit.

#### STEP 3 - Making the stick profile on rails, stile, sash bar and muntins

To mill the stick profile along the inside edges of all sash parts, place the already milled cope profile front face down on the router table and adjust the sash bit so that the lower edge of the top cutter will exactly touch the upper edge of the tenon as shown in need to 3 illustrations. With the rail still face down on the table, turn it so the inside edge of the rail is touching the bit and mill the stick profile. Mill the inside edges of the stiles and mill both edges of the front face of the sash bar and muntins.

To cut the slots for the tenons, measure 16mm from the front face of the stiles and rout with a table saw.

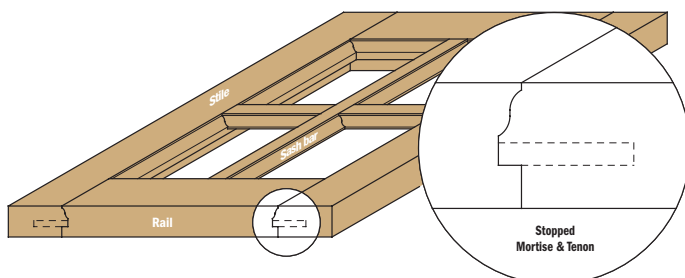
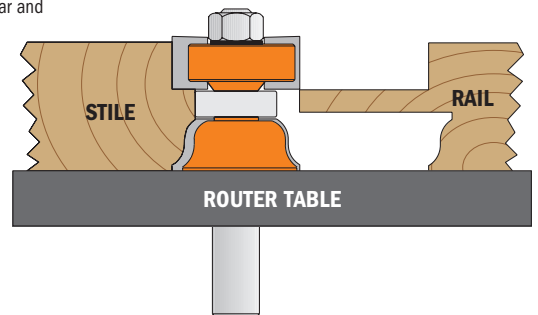
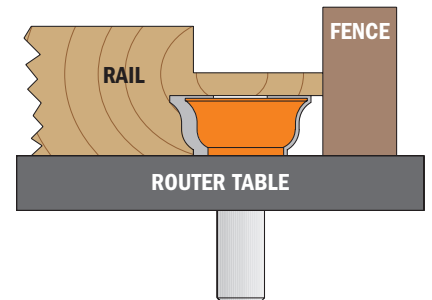
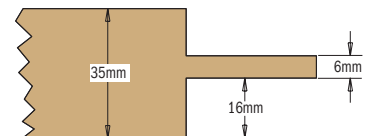

# Ovolo Sash Bits



## 8/955.3

These bits allow you to make true divided light doors for fine furniture and cabinets as well as sash bar windows, and stile and rail constructions. The glazing bar ovolo bits are bearing-guided to enable curved frames to be moulded. Cove bits can be used to produce easy-to-pull drawer handles.

Drawings are 1:1 scale

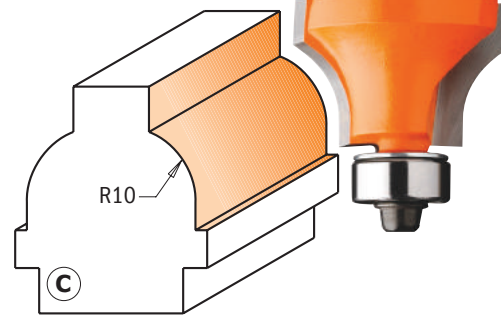
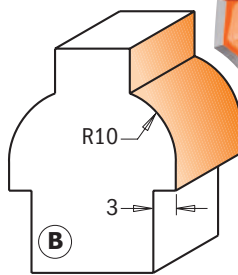
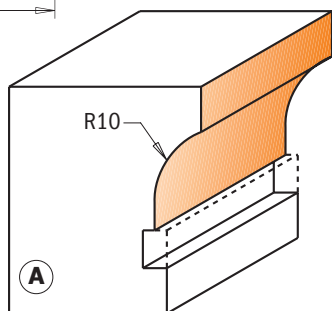

D mm	I mm	R mm	L mm	PROFILE		ORDER NO. S=∅6,35mm	ORDER NO. S=∅8mm
25	19	10	50,8	A	10	<b>855.307.11M</b>	<b>955.307.11M</b>
22	19	10	50,8	B	10	<b>855.307.11F</b>	<b>955.307.11F</b>
28	19	10	61,2	C	10	<b>855.308.11F</b>	<b>955.308.11F</b>

Spare parts

990.423.00	791.003.00	990.058.00	991.057.00

# Ovolo Sash Set

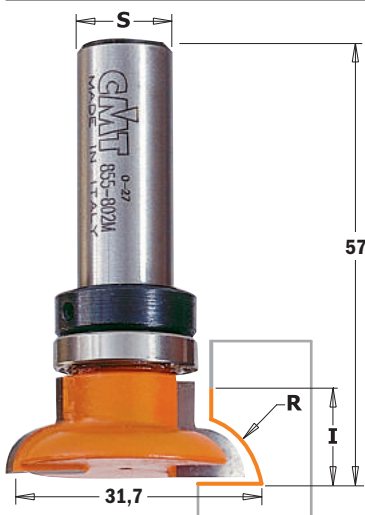

## 955.302 - 855.802

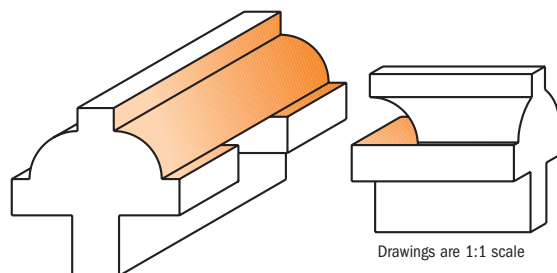
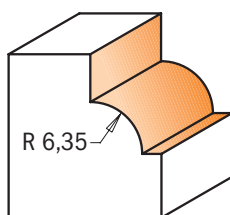
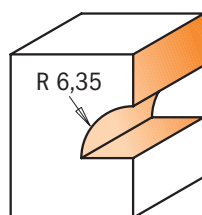
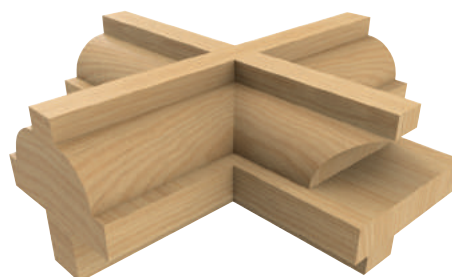

Drawings are 1:1 scale

d mm	D mm	I mm	R mm		ORDER NO. S=∅8mm	ORDER NO. S=∅12,7mm
30	31,7	12	6,35	5	<b>955.302.11</b>	<b>855.802.11</b>

Spare parts

990.423.00	791.003.00	990.058.00	991.057.00	791.011.00	541.002.00

Spare parts 991.056.00 1,5mm hex key



# Finger Joint Bit

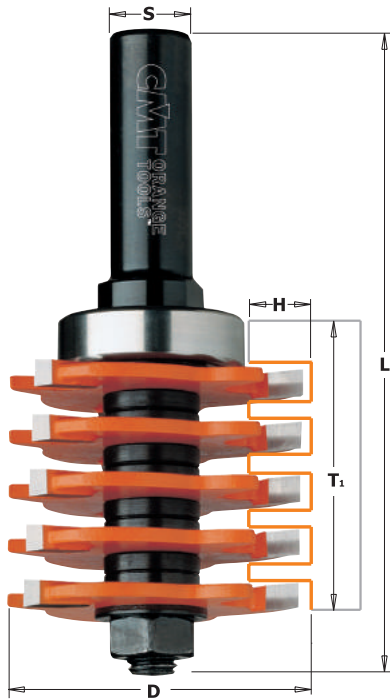

## 8/900.616



This router allows you to carry out accurate and functional finger joints with the greatest of ease. Without any adjustment you will be able to work woods with different thicknesses as indicated in the drawing. The bearing allows you to reach a 9,5mm cutting depth. For further cutting depths you need to use a fence.

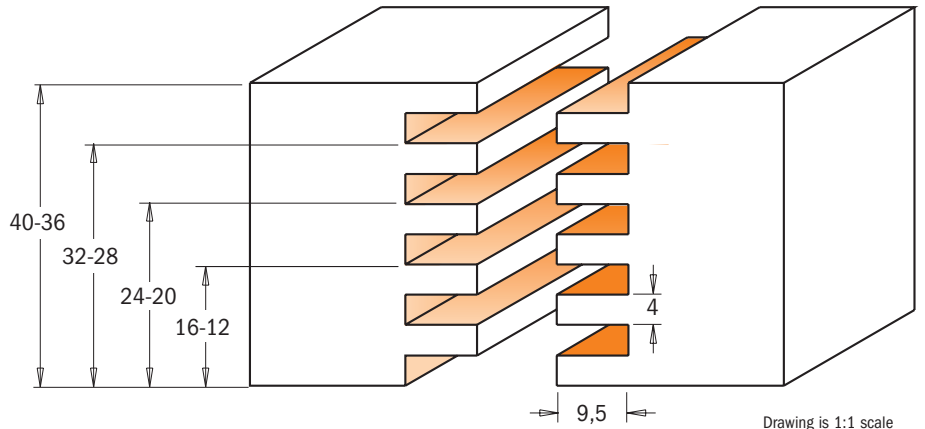

Drawing is 1:1 scale

T <sub>1</sub> mm	D mm	H mm	L mm		ORDER NO. S=∅12mm	ORDER NO. S=∅12,7mm	Spare parts							
12 - 40	47,6	9,5	97	10	<b>900.616.11</b>						924.130.00	791.027.00	822.340.11	990.020.00
12 - 40	47,6	9,5	97	10		<b>800.616.11</b>					824.130.00	791.027.00	822.340.11	990.020.00

**Spare parts**

541.515.00	0,1mm spacer
541.519.00	5,8mm spacer
990.403.00	1,6mm washer
990.459.00	Kit with spacers

**Optional**

791.020.00	∅38,1mm bearing (for depth 4,75mm)
791.029.00	∅34,9mm bearing (for depth 6,35mm)
791.015.00	∅31,7mm bearing (for depth 8mm)
791.011.00	∅19mm bearing (for depth 14,3mm)

# Professional Finger Joint Bit

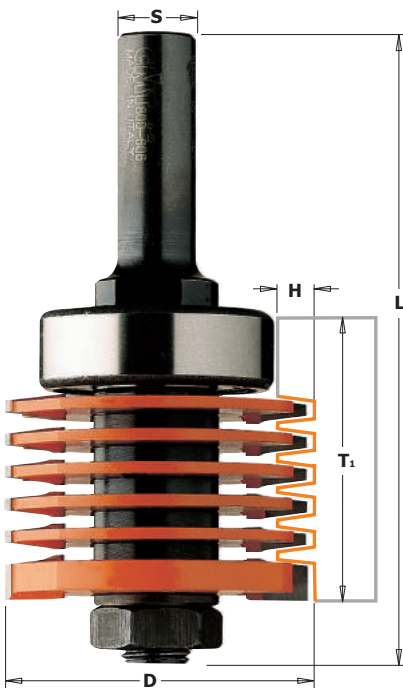

## 8/900.606



This versatile finger joint bit is the perfect tool for making incredibly strong side-to-side or end-to-end joints in wood and wood composites. The tightness and accuracy of the cut joint coupled with the maximum glue surface create a joint that is actually stronger than an unworked piece of wood. CMT's professional finger joint bit features two-flute design, carbide teeth and six removable cutters. This means you can make joints in a wide range of stock thicknesses - from 12,7mm to 36mm. Ideal for moulding manufacturers and furniture makers.

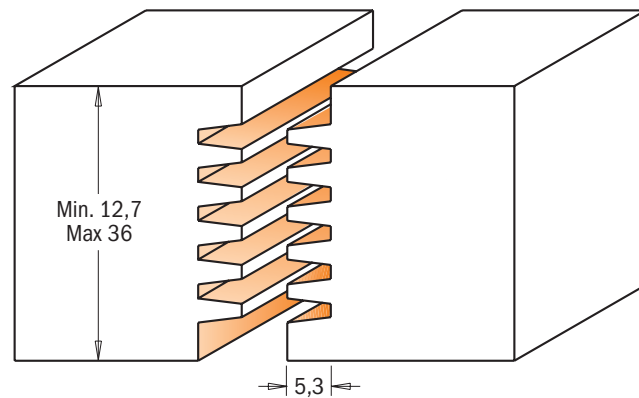

Drawing is 1:1 scale

T <sub>1</sub> mm	D mm	H mm	L mm		ORDER NO. S=∅12mm	ORDER NO. S=∅12,7mm	Spare parts									
12,7 - 36	47,6	5,3	97	10	<b>900.606.11</b>							924.129.00	791.028.00	822.005.11	822.006.11	990.022.00
12,7 - 36	47,6	5,3	97	10		<b>800.606.11</b>						824.129.00	791.028.00	822.005.11	822.006.11	990.022.00

**Spare parts**

541.511.00	3mm spacer	541.526.00	0,1mm spacer
541.512.00	2mm spacer	990.458.00	Kit with spacer

# V-Tongue & Groove Set

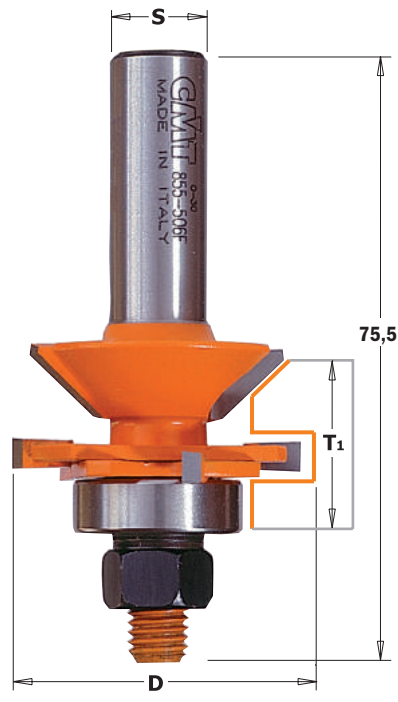

**8/955.506**

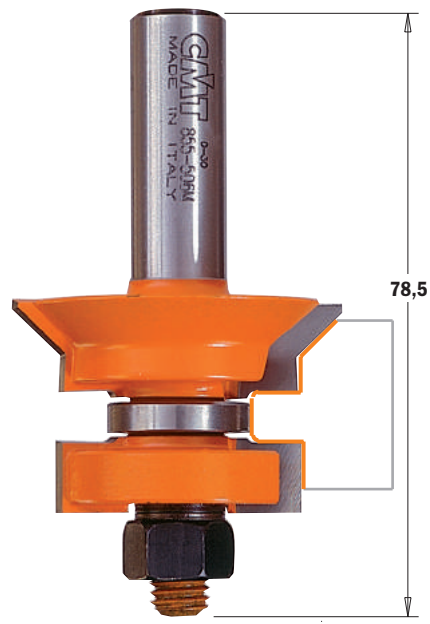

If the standard selection of moulding and mill work you find in today's lumber shops isn't satisfactory to your woodworking tastes, then consider CMT's moulding system instead. With these bits, you can make dozens of elaborate profiles by combining two or more passes. Avoid the average and create your own mouldings. Some initial suggestions are illustrated below.

**SAFETY TIPS:** use these bits with a fence. The profiles shown below are milled from heavy stock then refined to the desired shape.

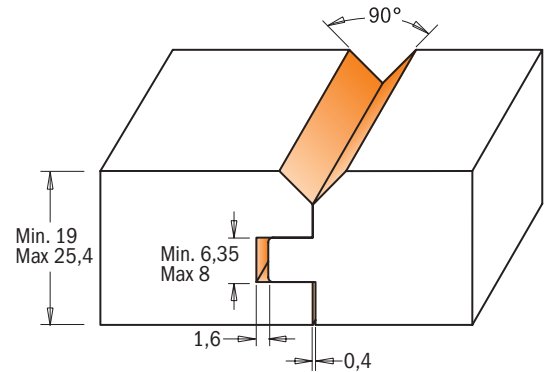

Drawing is 1:1 scale

D mm	T1 mm		ORDER NO. S=Ø12mm	ORDER NO. S=Ø12,7mm	Spare parts				
44,4	19÷25,4	10	<b>955.506.11</b>	<b>855.506.11</b>	8mm	4mm	19mm	22mm	990.020.00

**Spare parts**  
 541.515.00 0,1mm spacer  
 541.516.00 0,3mm spacer  
 541.517.00 0,5mm spacer  
 990.407.00 Shield

# Edge Banding Bits Set

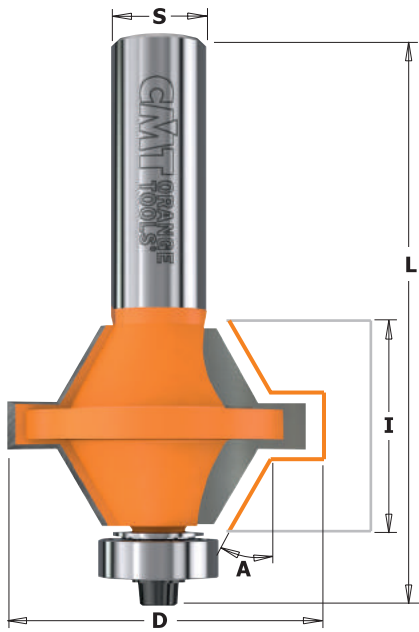

**8/955.510**



This is a great set to create cost-effective, yet attractive durable edges to your cabinet doors. For use with 1/2 " or 1 " thick panels in plywood or MDF or create your own edge banding with your wood of preference.

Easy to use: center each cutter on the stock and make the cut; glue the two pieces together; flush trim after assembly, if necessary. The set features a 60° angle tongue & groove with an ample surface area for glue application.

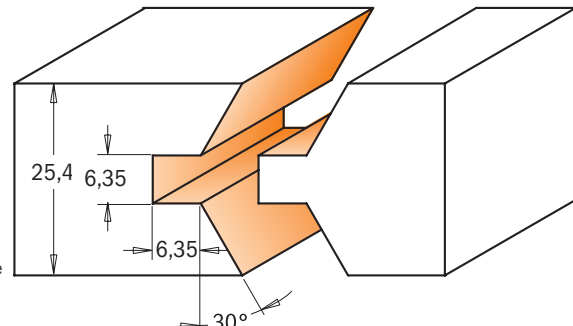
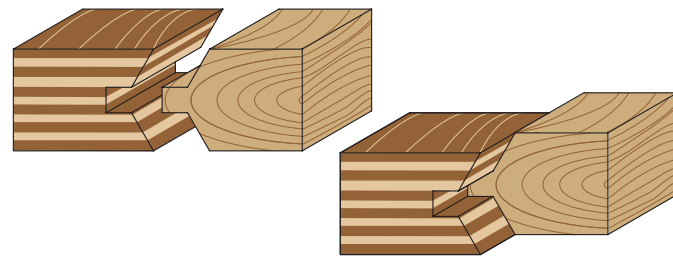

Drawing is 1:1 scale



D mm	I mm	A	L mm		ORDER NO. S=Ø12mm	ORDER NO. S=Ø12,7mm	Spare parts			
40	25,4	30°	74,5	5	<b>955.510.11</b>	<b>855.510.11</b>	990.423.00	791.018.00	990.058.00	991.057.00

# Dovetail Bits

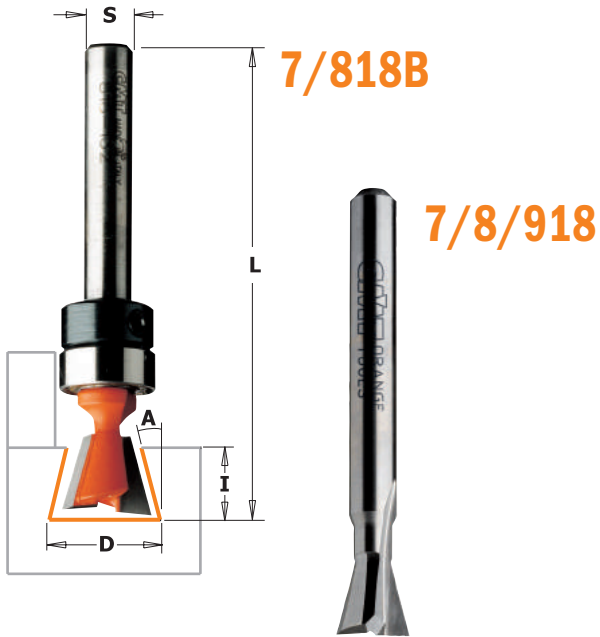

The beautifully crafted dovetail joint is a classic that appeals to both professionals and novices alike. Admired for its attractiveness in box and exposed joint projects, the dovetail is remarkably strong and functional. CMT dovetail bits are available in 25 different sizes so you can stretch your creativity to the limit.

See the illustrations on the next page for dovetail joinery possibilities. CMT dovetail bits are designed to fit all popular jigs including Leigh®, Keller®, JoinTECH® and Omnijig® systems. You are sure to find the bit you are looking for in our vast selection of cutting sizes and angles.

Check the overall length of the bit before placing an order to be sure you get the size you need - CMT makes bits specifically to fit on jigs and routers that require a longer shank length.

**SHOP TIPS:** two passes are recommended when routing dovetails with a template. Check that the dovetails have been cut through completely and smoothly before removing the workpiece.

For even easier routing and less stress on your dovetail bit, run the first pass with a straight bit. Use a dovetail on your router table equipped with a fence to achieve difficult chamfer angles.

**SAFETY TIPS:** if a dovetail bit jams while working, adjust the position of the bit in the collet and make sure the cutting depth is correct. Do not lift the router out of the template.

Drawings are 1:1 scale

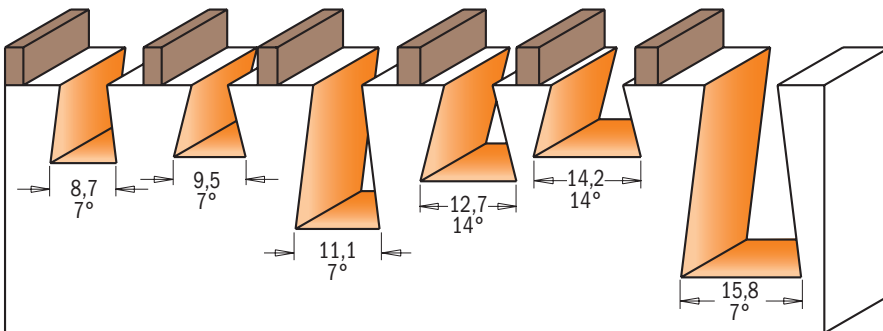
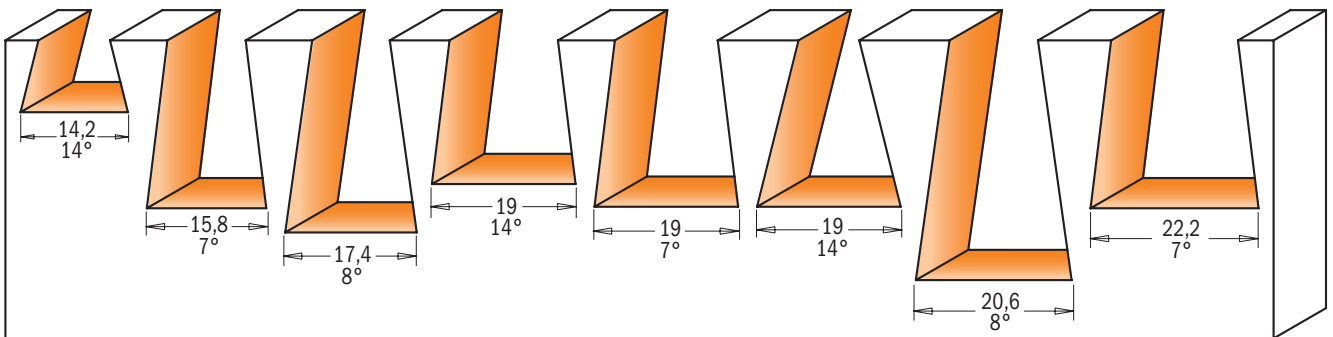
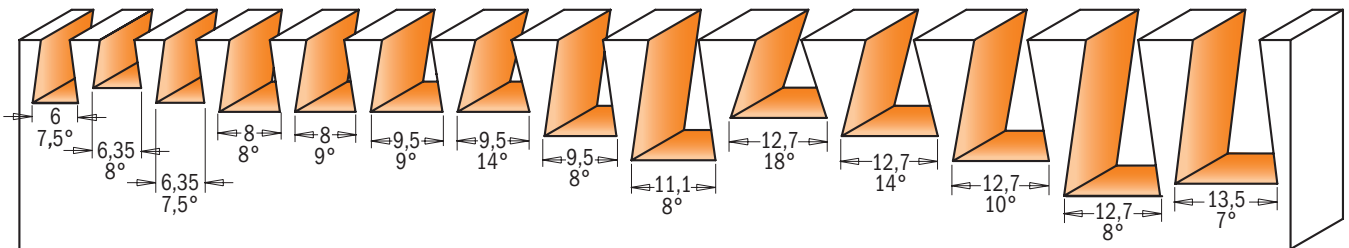

Fit Manufacturer Model	ORDER NO.	
CMT-Enlock10	718.098.11B	818.098.11B
CMT-Enlock15	718.127.11B	818.128.11B
CMT300	718.127.11	818.128.11
	918.127.11	818.628.11

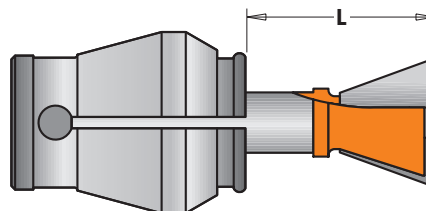
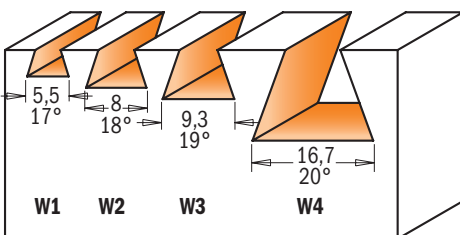

Manufacturer/Model	ORDER NO.	
<b>FIT HOFFMANN KEYS</b>		
W1 L=16mm	718.053.11	818.053.11
W2 L=17,5mm	718.079.11	818.079.11
W3 L=19mm	718.093.11	818.093.11
W4 L=25mm	918.167.11	

**FIT HOFFMANN KEYS**



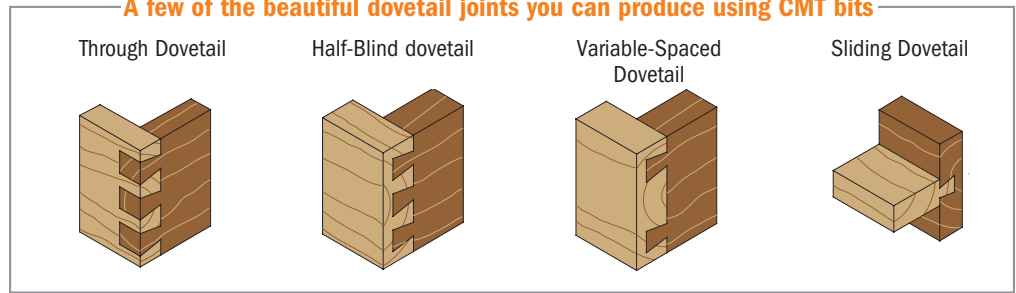

**7/8/918 - 7/818B**

A few of the beautiful dovetail joints you can produce using CMT bits

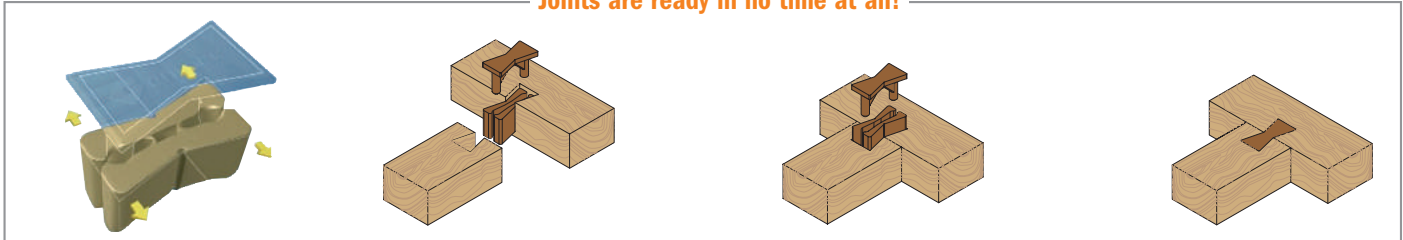

Joints are ready in no time at all!





D mm	I mm	L mm	A		ORDER NO. S=Ø6mm	ORDER NO. S=Ø6,35mm	ORDER NO. S=Ø8mm	ORDER NO. S=Ø12mm	ORDER NO. S=Ø12,7mm
•6	8,3	60	7,5°	10	<b>718.060.11</b>				
•6,35	6,35	50,8	8°	10		<b>818.065.11</b>			
•6,35	8,3	63,5	7,5°	10		<b>818.064.11</b>			<b>818.564.11</b>
•8	9,5	54	8°	10		<b>818.081.11</b>			
•8	9,5	52,5	9°	10		<b>818.080.11</b>			
•8	9,5	63,5	9°	10					<b>818.580.11</b>
9,5	9,5	52,5	9°	10	<b>718.095.11</b>	<b>818.096.11</b>	<b>918.095.11</b>		
9,5	9,5	63,5	9°	10					<b>818.596.11</b>
•9,5	9,5	60,3	14°	10		<b>818.098.11</b>			
•9,5	12,7	60,3	8°	10		<b>818.097.11</b>			
11,1	15,9	60,3	8°	10		<b>818.111.11</b>			
12,7	10,3	60,3	18°	10		<b>818.132.11</b>			
12,7	12,7	52,4	14°	10	<b>718.127.11</b>	<b>818.128.11</b>	<b>918.127.11</b>		
12,7	12,7	63,5	14°	10					<b>818.628.11</b>
12,7	12,7	62	14°	10		<b>818.130.11</b>			
12,7	16	60,3	10°	10		<b>818.133.11</b>			
12,7	20,6	69,8	8°	10		<b>818.129.11</b>	<b>918.129.11</b>		
13,5	19,05	61,5	7°	10					<b>818.635.11</b>
14,2	9,5	50,8	14°	10		<b>818.142.11</b>			
15,8	22	60,3	7°	10	<b>718.158.11</b>	<b>818.158.11</b>	<b>918.158.11</b>		
15,8	22	66,7	7°	10				<b>918.658.11</b>	<b>818.658.11</b>
17,4	25,4	77,6	8°	10					<b>818.674.11</b>
19	19	77,6	14°	10					<b>818.691.11</b>
19	22	60,3	7°	10	<b>718.190.11</b>	<b>818.190.11</b>	<b>918.190.11</b>		
19	22	66,7	7°	10				<b>918.690.11</b>	<b>818.690.11</b>
19	22	60,3	14°	10		<b>818.191.11</b>			
20,6	31,7	84,1	8°	10					<b>818.706.11</b>
22,2	22,2	69,8	7°	10					<b>818.722.11</b>
<b>With Top Bearing</b>									
8,73	10,3	58	7°	10		<b>818.087.11B</b>			
•9,5	9,5	60,3	14°	10	<b>718.098.11B</b>	<b>818.098.11B</b>			
11,1	19	66,7	7°	10		<b>818.113.11B</b>			
12,7	12,7	52,4	14°	10	<b>718.127.11B</b>	<b>818.128.11B</b>			
14,2	9,5	50,8	14°	10		<b>818.142.11B</b>			
<b>With Top Bearing (shank Ø9,5mm)</b>									
15,8	25,4	68,3	7°	10			<b>818.159.11B</b>		
<b>Fit Hoffmann Keys</b>									
•5,5	4	43	17°	10	<b>718.053.11</b>	<b>818.053.11</b>			
•8	6	43	18°	10	<b>718.079.11</b>	<b>818.079.11</b>			
•9,3	7,3	43	19°	10	<b>718.093.11</b>	<b>818.093.11</b>			
16,7	12,5	49	20°	10			<b>918.167.11</b>		

**7/8/918**



Spare parts

	
791.009.00	541.001.00
791.010.00	541.001.00
791.009.00	541.001.00
791.010.00	541.001.00
791.010.00	541.001.00
791.021.00	541.006.00

Spare parts 990.005.00 M3x3mm TSEI screw  
991.056.00 1,5mm hex key

• HWM

# 9° Dovetail Cutters

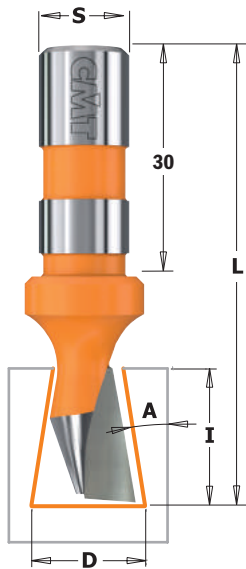

**522**



D mm	I mm	L mm	A	S mm		ORDER NO. Right-hand rotation
14	18	60	9°	12	10	<b>522.140.11</b>

**TECHNICAL DETAILS:**

- Super strength steel
- 1 HW precision ground cutting edge [Z1]

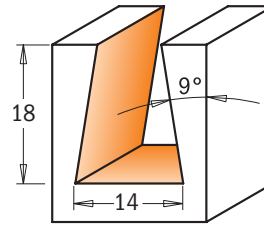

Drawing is 1:1 scale

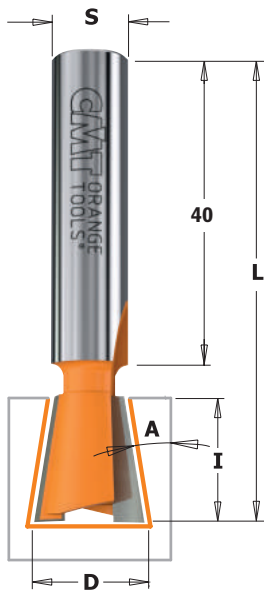

**523**



D mm	I mm	L mm	A	S mm		ORDER NO. Right-hand rotation
14	16	60	9°	10	10	<b>523.140.11</b>

**TECHNICAL DETAILS:**

- Super strength steel
- 2 HW precision ground cutting edges [Z2]

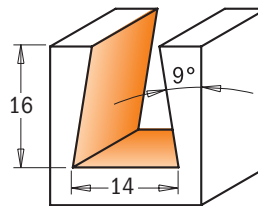

Drawing is 1:1 scale

# 15° Dovetail Cutter with Insert Knives for Roof-Frames

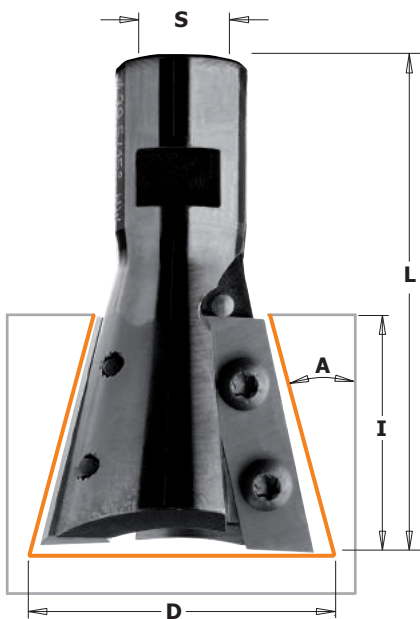

**664**



D mm	I mm	L mm	A	S mm		ORDER NO. Right-hand rotation
39,5	31,5	65,5	15°	M12x1	1	<b>664.395.11</b>

**TECHNICAL DETAILS:**

- Super strength steel
- 2 HWM precision insert knives [Z2]

**APPLICATION:**

This cutter allows you to assemble roof-frames by dovetailing.

**Spare parts**

790.315.00	990.078.00	991.061.00

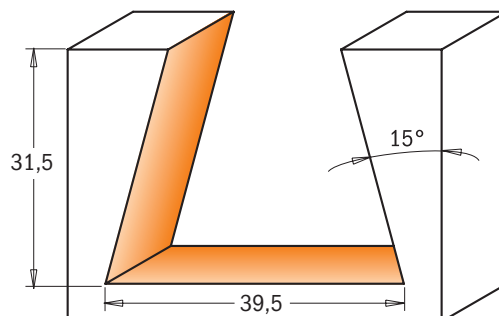

Drawing is 1:1 scale

# 60° Lettering Bit



**8/949B**

**7/8/949**

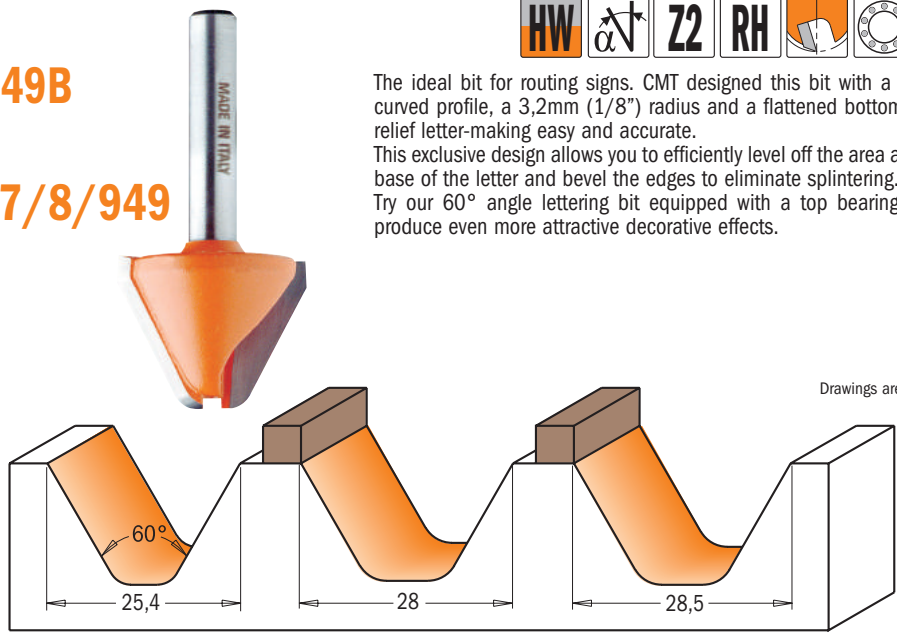

The ideal bit for routing signs. CMT designed this bit with a 60° angle curved profile, a 3,2mm (1/8") radius and a flattened bottom to make relief letter-making easy and accurate. This exclusive design allows you to efficiently level off the area around the base of the letter and bevel the edges to eliminate splintering. Try our 60° angle lettering bit equipped with a top bearing guide to produce even more attractive decorative effects.

Drawings are 1:1 scale

D mm	I mm	A	L mm		ORDER NO. S=Ø6mm	ORDER NO. S=Ø6,35mm	ORDER NO. S=Ø12mm	ORDER NO. S=Ø12,7mm	Spare parts		
25,4	19	60°	50,8	10	<b>749.001.11</b>	<b>849.001.11</b>					
28	19	60°	63,5	10			<b>949.502.11</b>				
28,5	19	60°	63,5	10				<b>849.501.11</b>			
<b>With Top Bearing</b>											
28	19	60°	63,5	10			<b>949.502.11B</b>		791.026.00	541.005.00	991.056.00
28,5	19	60°	63,5	10				<b>849.501.11B</b>	791.027.00	541.002.00	991.056.00

Spare parts 990.005.00 M3x3mm STEEL screw

# Bowl & Tray Bits

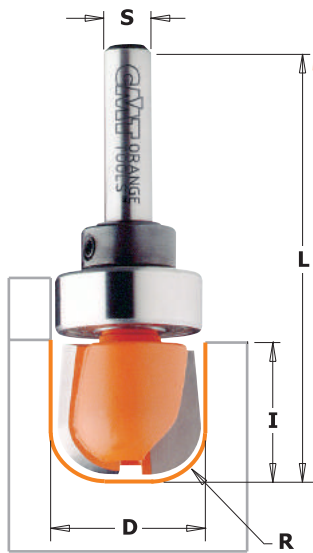

**7/851B**

**7/8/951**

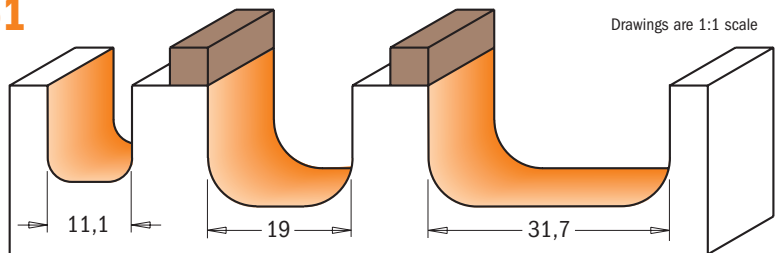

This CMT bit is ideal for making bowls, trays, boxes, cutting boards or any other specialty or craft item. The round corner of the bit shapes the inner radius while the sides and bottom create the smooth flat surfaces. Makes pattern work quick and easy. For best results on jobs where accuracy is a priority, we recommend using our top bearing bowl and tray bits shown at the bottom of this page. Bowl and Tray bits with top bearings are great for pattern work. Use them to create raised sign lettering, trays and a variety of other items.

Drawings are 1:1 scale

D mm	I mm	R mm	L mm		ORDER NO. S=Ø6mm	ORDER NO. S=Ø6,35mm	ORDER NO. S=Ø8mm	ORDER NO. S=Ø12mm	ORDER NO. S=Ø12,7mm	Spare parts		
11,1	12,7	3,2	45,5	10		<b>851.001.11</b>						
19	16	6,4	54	10	<b>751.002.11</b>	<b>851.002.11</b>	<b>951.002.11</b>					
19	16	6,4	60,4	10				<b>951.501.11</b>	<b>851.501.11</b>			
31,7	16	6,4	60,4	10				<b>951.502.11</b>	<b>851.502.11</b>			
<b>With Top Bearing</b>												
19	16	6,4	54	10	<b>751.002.11B</b>					791.007.00	541.003.00	991.056.00
19	16	6,4	54	10		<b>851.002.11B</b>				791.004.00	541.001.00	991.056.00
19	16	6,4	60,4	10					<b>851.501.11B</b>	791.011.00	541.002.00	991.056.00
31,7	16	6,4	60,4	10				<b>951.502.11B</b>	<b>851.502.11B</b>	791.015.00	541.002.00	991.056.00

Spare parts 990.005.00 M3x3mm STEEL screw



# V-Grooving Bits (90°)



## 7/8/915

These double cutting edge CMT bits offer an almost endless range of woodworking possibilities. Make clean, perfect cuts in panels, drawer fronts or even plasterboard panels; chamfer edges or engrave beautiful lettering.

**TIPS:** these bits perfectly chamfer at 45° angles (Two tools in one).

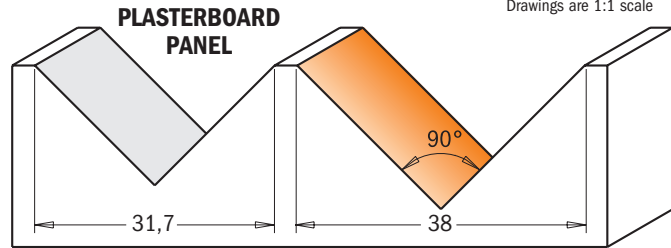
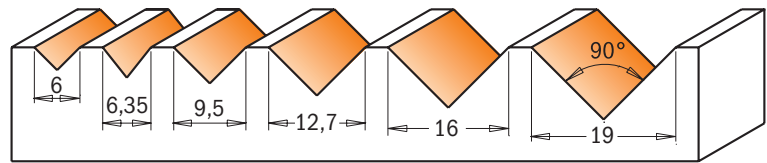

• HWM

D mm	I mm	I <sub>1</sub> mm	A	L mm		ORDER NO. S=Ø6mm	ORDER NO. S=Ø6,35mm	ORDER NO. S=Ø8mm	ORDER NO. S=Ø12mm	ORDER NO. S=Ø12,7mm
• 6	8	3	90°	46	10	<b>715.060.11</b>		<b>915.060.11</b>		
• 6,35	8	3,18	90°	46	10		<b>815.064.11</b>			
9,5	12,7	4,75	90°	44,5	10	<b>715.095.11</b>	<b>815.095.11</b>	<b>915.095.11</b>		
12,7	12,7	6,35	90°	44,5	10	<b>715.127.11</b>	<b>815.127.11</b>	<b>915.127.11</b>		
16	12,7	8	90°	52,8	10			<b>915.160.11</b>		
16	12,7	8	90°	63,5	10				<b>915.660.11</b>	<b>815.660.11</b>
19	16	9,5	90°	55,5	10	<b>715.190.11</b>				
19	16	9,5	90°	63,5	10				<b>915.690.11</b>	<b>815.690.11</b>
31,7	19	15,88	90°	63,5	10			<b>915.317.11</b>	<b>915.817.11</b>	<b>815.817.11</b>
38	28,5	19	90°	63,5	10			<b>915.380.11</b>		
38	28,5	19	90°	70	10					<b>815.880.11</b>



## 7/8/915B



In addition, CMT has versatile top bearing bits that allow for several template options of your choice (see series 715B-815B-915B). Like all CMT bits, they are made of super strength Fatigue Proof® steel with carbide-tipped cutting edges and are coated with our trademark orange PTFE non-stick coating. These bits are ideal for routing signs, or almost any project that is suitable for accurate template routing.

**TIPS:** these bits perfectly chamfer at 45° angles (Two tools in one)

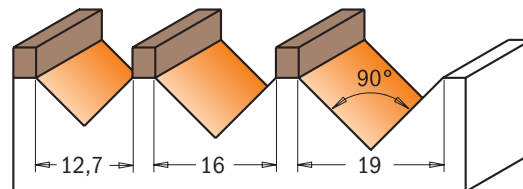

Drawings are 1:1 scale

D mm	I mm	I <sub>1</sub> mm	A	L mm		ORDER NO. S=Ø6mm	ORDER NO. S=Ø6,35mm	ORDER NO. S=Ø8mm	ORDER NO. S=Ø12,7mm	Spare parts		
12,7	12,7	6,35	90°	44,5	10		<b>815.127.11B</b>					
16	12,7	8	90°	52,8	10			<b>915.160.11B</b>		791.010.00	541.001.00	991.056.00
19	16	9,5	90°	55,5	10	<b>715.190.11B</b>				791.025.00	541.004.00	991.056.00
19	16	9,5	90°	63,5	10				<b>815.690.11B</b>	791.007.00	541.003.00	991.056.00
										791.011.00	541.002.00	991.056.00

Spare parts 990.005.00 M3x3mm STEI screw



## 915

HW Z2 RH

Aluminium Composite Material (ACM) panels can be shaped using a very simple processing method. This technique referred to as the 'routing and folding' method, means ACM paneling can be manipulated in a variety of shapes and sizes.

- a V-shaped groove is routed on the reverse side of the panel using a V-groove router bit thus leaving a thin layer of the core material at the base of the groove - i.e. on the inside of the outer cover sheet;
- the untouched outer cover sheet can now be bent manually, giving an exact, clean folding line along the routed groove. The shape and depth of the groove will determine the outer radius of the folded edge.

We recommend all routing to be done on either a CNC machine, a portable sheet milling machine or a hand router. The 'routing and folding' method can be used on any ACM product such as Alucobond®, Dibond® or any other product alike. The advantages of this unique technique are:

- Low investment cost
- Simple fabrication technique
- Folding can be done on site, saving transportation costs
- Low-cost fabrication of shaped components, wall cladding, roof edgings, column cladding, flashings, etc.
- Flexibility in creating shapes
- Very cost effective
- Shapes are not limited by machine capacity.

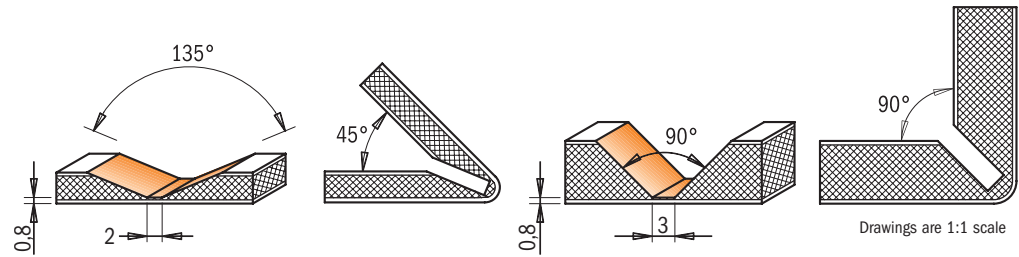

D mm	I mm	A	L mm		ORDER NO. S=Ø6mm	ORDER NO. S=Ø6,35mm	ORDER NO. S=Ø8mm
18	7,4	90°	60	10	<b>715.001.11</b>	<b>815.001.11</b>	<b>915.001.11</b>
18	3,3	135°	60	10	<b>715.002.11</b>	<b>815.002.11</b>	<b>915.002.11</b>

# Laser Point Bit



## 7/8/958

HWM HW Z1 Z2 Z3 RH

This bit crafts delicate grooves and incisions with laser precision. Make one-of-a-kind effects with 30° bevel edges in one single run. Equipped with three super sharp cutting edges, this perfectly balanced bit allows you to work with incredible accuracy with no risk of burning. Raise the bit and produce a delicate fine point incision, or work the whole 12,7mm diameter to render bold highlighted lettering. Super strong steel shank and micrograin carbide cutting edges guarantee long lasting performance.



7/858.002

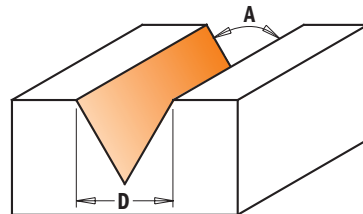
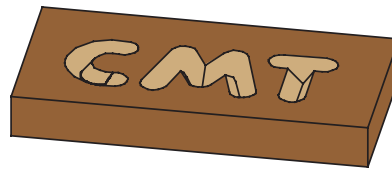

Drawing is 1:1 scale



8/958.003

• HWM

D mm	I mm	A	Z	L mm		ORDER NO. S=Ø6mm	ORDER NO. S=Ø6,35mm	ORDER NO. S=Ø8mm	ORDER NO. S=Ø12,7mm
•6	9	35°	1	50	10	<b>758.002.11</b>			
•6,35	9,5	35°	1	50,8	10		<b>858.002.11</b>		
12,7	11	60°	3	57,2	10	<b>758.001.11</b>	<b>858.001.11</b>	<b>958.001.11</b>	
12,7	11	60°	3	60,3	10				<b>858.501.11</b>
12,7	10	60°	2	50,8	10		<b>858.003.11</b>	<b>958.003.11</b>	

# V-Grooving & Signmaking Router Bits with indexable knives (90°)



## 665

These bits have been designed for signmaking and lettering. When the insert shows signs of wear, you can simply rotate it to exploit the other cutting edges. A locking screw secures the insert tightly for added safety and extreme cutting accuracy.

**TECHNICAL DETAILS:**

- Super strength steel.
- 1 HW precision insert knife [Z1].

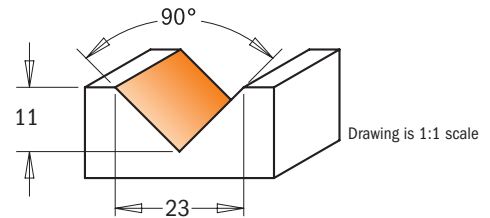
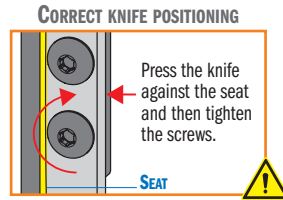
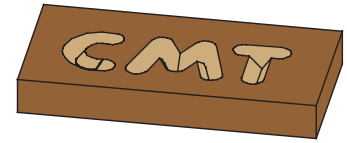

A	D mm	I mm	L mm		ORDER NO. S=Ø6,35mm	ORDER NO. S=Ø8mm	Spare parts		
90°	23	11	60	10	665.201.11	665.200.11			
							790.280.00	990.093.00	991.073.00

# Stepped Rebate Router Bit

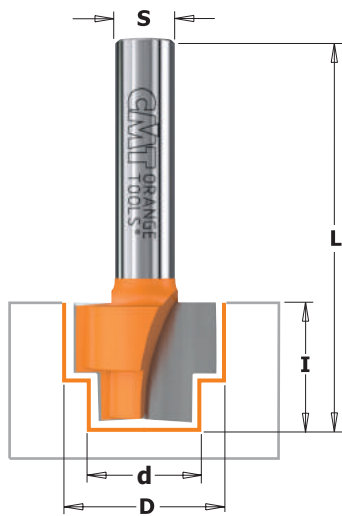

## 965

Router bit featuring 2 carbide-tipped cutting edges for producing double rebates on wood and wood composites. Designed for accepting library/bookcase shelving strips or for accommodating hardware into your window slots.

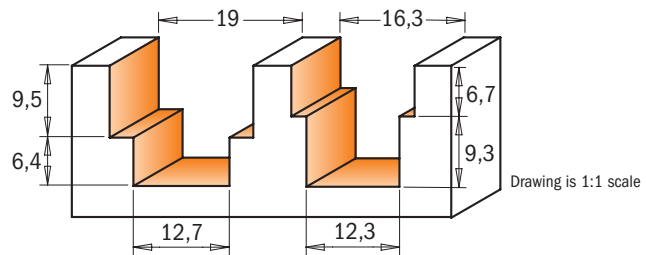

d mm	D mm	I mm	L mm		ORDER NO. S=Ø8mm
12,3	16,3	16	80	10	965.122.11
12,7	19	15,9	50,8	10	965.121.11



# Chamfer Bits

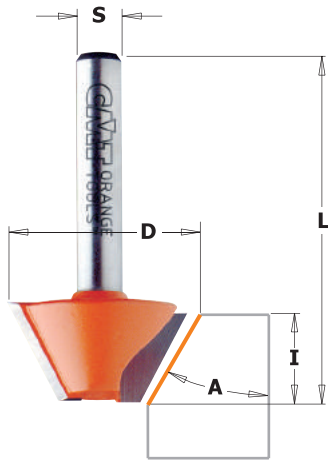

## 703/4/5 - 903/4/5



From a gently beveled edge to decorative chamfers in a variety of materials, CMT offers smooth results.

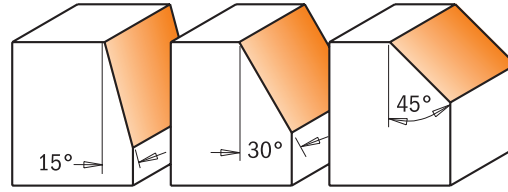

Drawings are 1:1 scale

A	D mm	I mm	L mm		ORDER NO. S=Ø6mm	ORDER NO. S=Ø8mm
15°	24	14	46	10	<b>703.240.11</b>	<b>903.240.11</b>
30°	26	12,7	44,5	10	<b>704.240.11</b>	<b>904.240.11</b>
45°	25	8	41	10	<b>705.240.11</b>	<b>905.240.11</b>

# Chamfer Bits with Insert Knives

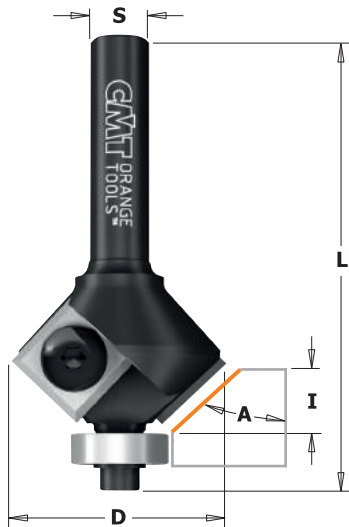

## 659



Bevel and Chamfer trim bits with two replaceable knives fixed by special Torx screws. The knives are sharpened on all 4 sides and provide three extra new edges. Guided bevel and chamfer trim bits type 659 are equipped with the ball bearing guides. Type 658 is unguided. For specialist applications requiring economy of replaceable tips. For precision work on laminates, MDF or for quick rounded edges in hard wood. For use on portable Routers or CNC machining centers.

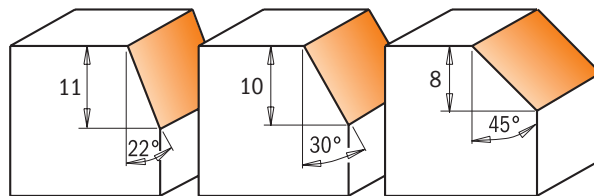
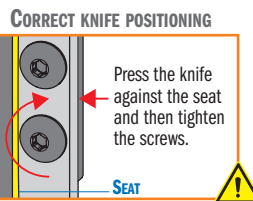

Drawings are 1:1 scale



A	D mm	I mm	L mm		ORDER NO. S=Ø6mm	ORDER NO. S=Ø6,35mm	ORDER NO. S=Ø8mm	ORDER NO. S=Ø12,7mm	Spare parts		
45°	29	8	52	10	<b>658.047.11</b>		<b>658.045.11</b>				
22°	25	11	65	10	<b>659.024.11</b>	<b>659.023.11</b>	<b>659.022.11</b>		790.120.00	990.075.00	791.006.00
30°	28	10	66	10	<b>659.032.11</b>	<b>659.031.11</b>	<b>659.030.11</b>		790.120.00	990.075.00	791.006.00
45°	29	8	60	10	<b>659.047.11</b>	<b>659.046.11</b>	<b>659.045.11</b>		790.120.00	990.075.00	791.022.00
45°	29	8	68	10				<b>659.646.11</b>	790.120.00	990.075.00	791.022.00

**Spare parts**

990.400.00	Ø3.2/Ø7mm shield for M3 screw
990.051.00	M3x6mm TCEI screw
991.062.00	2,5mm hex key
991.061.00	T15 Torx key

**Chamfer Bits**



**7/8/936 - 8/957**

CMT chamfer bits can cut clean, accurate bevels and chamfers and are great for edge work or for making perfectly aligned multi-sided containers, boxes and other decorative projects. See illustration below for examples. Can be used for working larger scale projects such as beams and columns with excellent results.

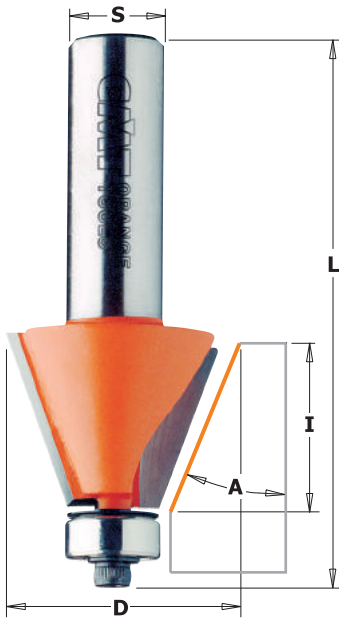

Drawings are 1:1 scale

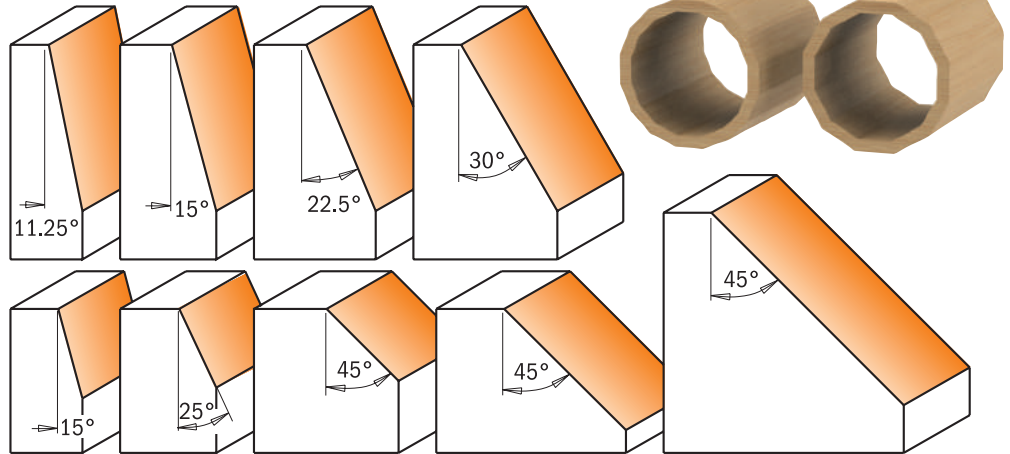

A	D mm	I mm	L mm		ORDER NO. S=Ø6mm	ORDER NO. S=Ø6,35mm	ORDER NO. S=Ø8mm	ORDER NO. S=Ø12mm	ORDER NO. S=Ø12,7mm
15°	19	11,5	54,9	10	<b>736.130.11</b>	<b>836.130.11</b>	<b>936.130.11</b>		
25°	22,2	10	54,9	10	<b>736.190.11</b>	<b>836.190.11</b>	<b>936.190.11</b>		
45°	31,7	9,5	53	10	<b>736.280.11</b>	<b>836.280.11</b>	<b>936.280.11</b>		
45°	45	18	60,2	10	<b>736.420.11</b>	<b>836.420.11</b>	<b>936.420.11</b>		
45°	45	18	66,5	10				<b>936.920.11</b>	<b>836.920.11</b>
45°	65	26	76,7	5				<b>936.950.11</b>	<b>836.950.11</b>
11,25°	21,5	22	71,1	10				<b>957.504.11</b>	<b>857.504.11</b>
15°	24,5	22	71,1	10				<b>957.503.11</b>	<b>857.503.11</b>
22,5°	31	22	71,1	10				<b>957.502.11</b>	<b>857.502.11</b>
30°	38,5	22	71,1	10				<b>957.501.11</b>	<b>857.501.11</b>

Spare parts

990.423.00	791.003.00	990.058.00	991.057.00
990.423.00	791.003.00	990.058.00	991.057.00
990.423.00	791.003.00	990.058.00	991.057.00
990.423.00	791.003.00	990.058.00	991.057.00
990.423.00	791.003.00	990.058.00	991.057.00
990.423.00	791.003.00	990.058.00	991.057.00
990.423.00	791.003.00	990.058.00	991.057.00
990.423.00	791.003.00	990.058.00	991.057.00
990.423.00	791.003.00	990.058.00	991.057.00
990.423.00	791.003.00	990.058.00	991.057.00

**SHOP TIPS:** undersized bearing to use after resharpening.  
**791.063.00** Ø12,5 replace bearing 791.003.00 (Ø12,7) after resharpening



**Chamfer Set**

**836**



Build beautiful planters, boxes and other multi-sided pieces with this handy set. Why cut imperfect angles on your table saw when it's so much easier and accurate to use the CMT Chamfer set? Our solution to accurate polygon construction includes 5 anti-kickback, carbide tipped bits in the most popular angles - 11-1/4°, 15°, 22-1/2°, 30° and 45°. No polygon project is too difficult. Available with 12,7mm shank.

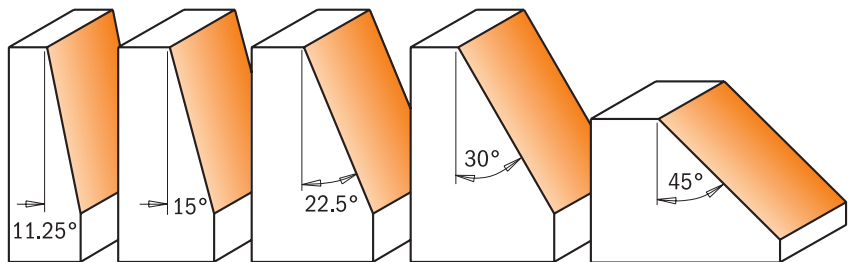

Drawings are 1:1 scale

DESCRIPTION		ORDER NO. S=Ø12,7mm
Chamfer Set	5	<b>836.501.11</b>

# Round Nose Bits

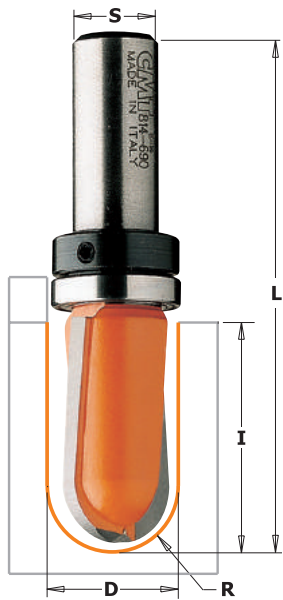

7/8/914B

7/8/914

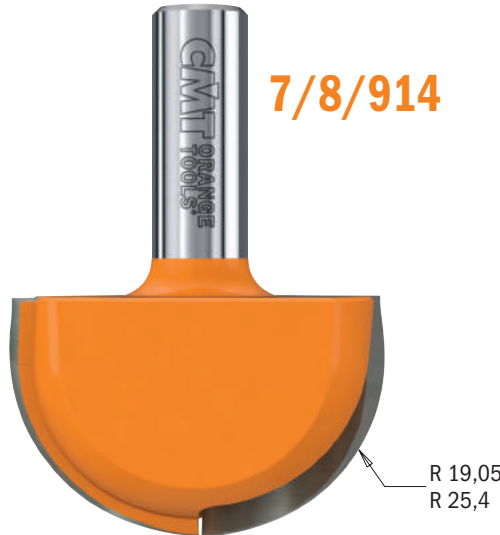

Personalize your doors, drawer fronts, panels or any surface you choose with your own signature motif. CMT round nose bits in solid carbide or with carbide tipped flutes let you create engraving in any wood or wood product. We offer a complete selection of diameters and cutting depths so you can achieve the effects you want. Mounted on your router table, you can work materials up to 31,7mm in depth.

For even more elaborate decorations, we also offer top bearing bits - use your own template with one of these bits to produce truly unique doors and drawer fronts. A favourite item for professional sign makers, craft makers and hobbyists.

**SHOP TIPS:** more than one pass is recommended when making cove edges. To prevent splintering, begin with a shallow initial pass and deepen gradually.

Drawings are 1:1 scale

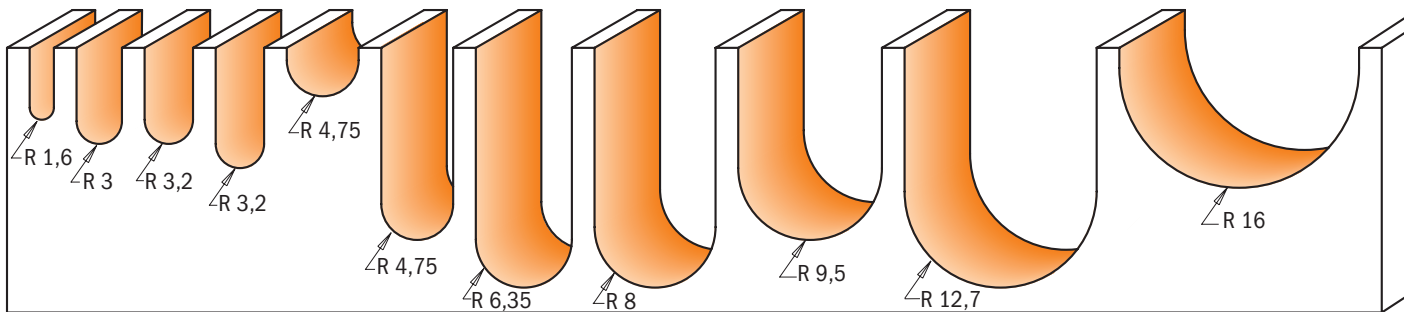

R mm	D mm	I mm	L mm		ORDER NO. S=Ø6mm	ORDER NO. S=Ø6,35mm	ORDER NO. S=Ø8mm	ORDER NO. S=Ø12mm	ORDER NO. S=Ø12,7mm
•1,6	3,2	9,5	50,8	10	714.032.11	814.032.11	914.032.11		
•1,6	3,2	12,7	50,8	10		199.001.11			
•3	6	12,7	50,8	10	714.060.11		914.060.11		
•3	6	27	70	10	199.060.11				
•3,2	6,4	12,7	50,8	10		814.064.11			
•3,2	6,4	25,4	63,5	10		199.008.11			
•3,2	6,4	15,9	63,5	10					814.564.11
•4	8	32	80	10			199.081.11		
4,75	9,5	6,4	50,8	10	714.095.11	814.095.11	914.095.11		
4,75	9,5	25,4	66,7	10					814.595.11
•6	12	35	80	10				199.120.11	
6,35	12,7	9,5	50,8	10	714.127.11	814.127.11	914.127.11		
6,35	12,7	31,7	73	10				914.627.11	814.627.11
•6,35	12,7	31,7	76,2	10					199.505.11
8	15,8	9,5	50,8	10	714.160.11	814.160.11	914.160.11		
8	15,8	31,7	73	10					814.660.11
9,5	19	11,3	50,8	10	714.190.11	814.190.11	914.190.11		
9,5	19	25	63,5	10			914.191.11		
9,5	19	31,7	73	10				914.690.11	814.690.11
11	22	25,4	63,5	10			914.221.11		
12,7	25,4	16	58,8	10			914.254.11		
12,7	25,4	31,7	73	10				914.754.11	814.754.11
16	31,7	18,5	58,8	10				914.817.11	814.817.11
19,05	38,1	31,7	69,8	10				914.880.11	814.880.11
25,4	50,8	31,7	69,8	10				914.990.11	814.990.11



199

**With Top Bearing**

6,35	12,7	9,5	50,8	10		814.127.11B			
8	15,8	9,5	50,8	10		814.160.11B			
8	15,8	9,5	50,8	10			914.160.11B		
9,5	19	11,3	50,8	10	714.190.11B				
9,5	19	11,3	50,8	10		814.190.11B			
9,5	19	31,7	73	10					814.690.11B

**Spare parts**

791.010.00	541.001.00	991.056.00
791.009.00	541.001.00	991.056.00
791.025.00	541.004.00	991.056.00
791.007.00	541.003.00	991.056.00
791.004.00	541.001.00	991.056.00
791.011.00	541.002.00	991.056.00

Spare parts 990.005.00 M3x3mm TSEI screw

• HWM



# Ball End Bit



**8/968**

Cut channels for pipes or cables in one single pass using CMT's ball end bits. Reduce the stress on the bits by cutting a first groove with a straight bit.

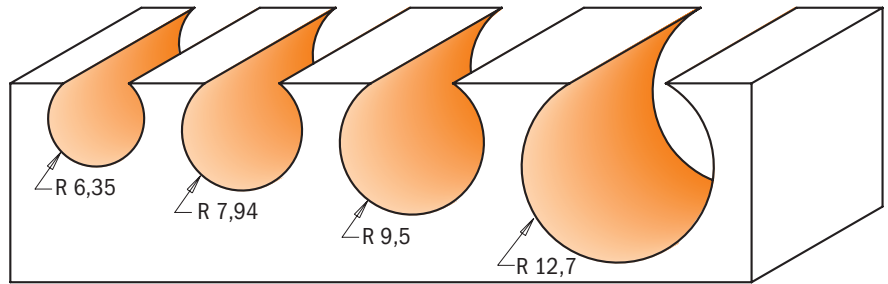

Drawings are 1:1 scale

R mm	D mm	I mm	L mm			ORDER NO. S=Ø8mm	ORDER NO. S=Ø12mm	ORDER NO. S=Ø12,7mm
6,35	12,7	11	57,15		10	<b>968.127.11</b>		<b>868.627.11</b>
7,94	15,88	14,2	60,3		10	<b>968.158.11</b>		<b>868.658.11</b>
9,52	19,05	17,4	63,5		10	<b>968.190.11</b>		<b>868.690.11</b>
12,7	25,4	23,5	70		10		<b>968.754.11</b>	<b>868.754.11</b>

# Round Nose Set



**814**

Each of these sets include 3 of the most widely used CMT Round Nose bits. These solid carbide or carbide tipped bits are perfect for sign making, engraving, or adding flutes and veins to doors or drawer fronts. Available in 6,35mm and 12,7mm shanks.

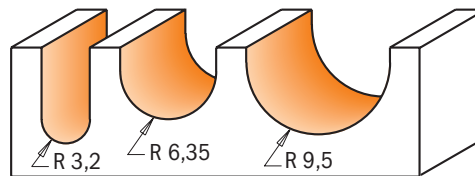

**814.001.11**

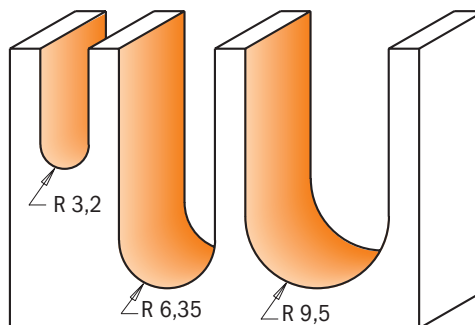

**814.501.11**

Drawings are 1:1 scale

DESCRIPTION		ORDER NO. S=Ø6,35mm	ORDER NO. S=Ø12,7mm
Round Nose Set	5	<b>814.001.11</b>	<b>814.501.11</b>

# Cove Bits

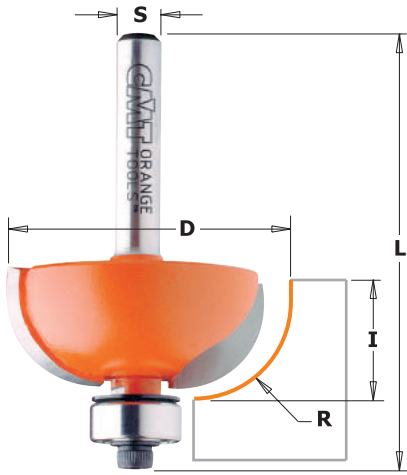

## 7/8/937

Make simple or elegant furniture, doors and drawer fronts by adding a final touch with CMT cove bits. Join them together with a CMT roundover bit and make perfectly fitting rule joints. Ideal for drop leaf counter and table tops. These bits feature anti-kickback design, carbide-tipped cutting edges, Fatigue Proof® steel body and PTFE non-stick coating.

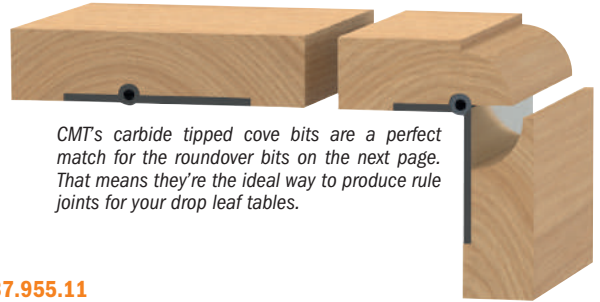
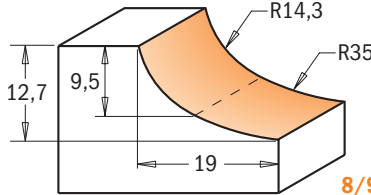

CMT's carbide tipped cove bits are a perfect match for the roundover bits on the next page. That means they're the ideal way to produce rule joints for your drop leaf tables.

8/937.955.11

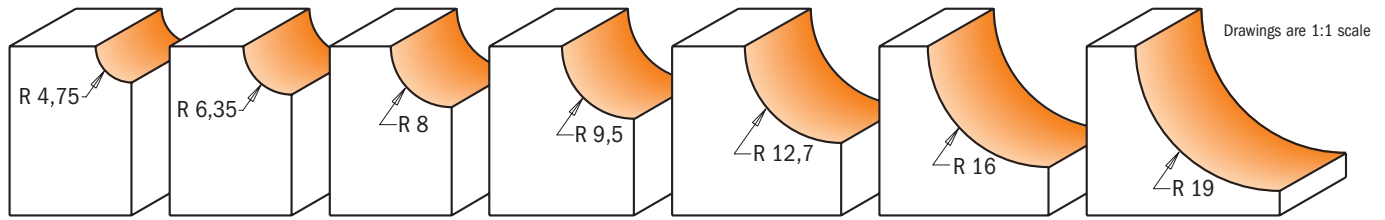

R mm	D mm	I mm	L mm		ORDER NO. S=Ø6mm	ORDER NO. S=Ø6,35mm	ORDER NO. S=Ø8mm	ORDER NO. S=Ø12mm	ORDER NO. S=Ø12,7mm	Spare parts							
4,75	22,2	12,7	54,9	10	737.190.11	837.190.11	937.190.11							990.423.00	791.003.00	990.058.00	991.057.00
4,75	22,2	12,7	61,2	10				937.690.11	837.690.11					990.423.00	791.003.00	990.058.00	991.057.00
6,35	25,4	12,7	54,9	10	737.222.11	837.222.11	937.222.11							990.423.00	791.003.00	990.058.00	991.057.00
6,35	25,4	12,7	61,2	10				937.722.11	837.722.11					990.423.00	791.003.00	990.058.00	991.057.00
8	28,7	12,7	54,2	10	737.254.11	837.254.11	937.254.11							990.423.00	791.003.00	990.058.00	991.057.00
8	28,7	12,7	60,5	10				937.754.11	837.754.11					990.423.00	791.003.00	990.058.00	991.057.00
9,5	31,7	12,7	54,2	10	737.286.11	837.286.11	937.286.11							990.423.00	791.003.00	990.058.00	991.057.00
9,5	31,7	12,7	60,5	10				937.786.11	837.786.11					990.423.00	791.003.00	990.058.00	991.057.00
12,7	38,1	15,5	57,7	10	737.350.11	837.350.11	937.350.11							990.423.00	791.003.00	990.058.00	991.057.00
12,7	38,1	15,5	64	10				937.850.11	837.850.11					990.423.00	791.003.00	990.058.00	991.057.00
16	44,5	18,5	67	10				937.950.11	837.950.11					990.423.00	791.003.00	990.058.00	991.057.00
19	50,8	22,2	70,7	10				937.951.11	837.951.11					990.423.00	791.003.00	990.058.00	991.057.00
14,3-35	50,8	12,7	61,2	10				937.955.11	837.955.11					990.423.00	791.003.00	990.058.00	991.057.00

# Cove Bit Set



## 837

See simple furniture, doors and drawer fronts transform into elegant pieces by giving them a final touch with a CMT Cove Bit. Pair them up with CMT Roundover Bits and make beautiful rule joints to create drop leaf counter and table tops.

Anti-kickback design and thick carbide tips for long lasting performance. Available with a 12,7mm or 6,35mm shank. Cove radii are 6,35mm, 9,5mm and 12,7mm.

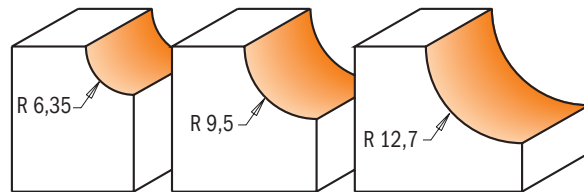

Drawings are 1:1 scale

DESCRIPTION		ORDER NO. S=Ø6,35mm	ORDER NO. S=Ø12,7mm
Cove Bit Set	5	837.001.11	837.501.11

# Cavetto Edge Mould Bits

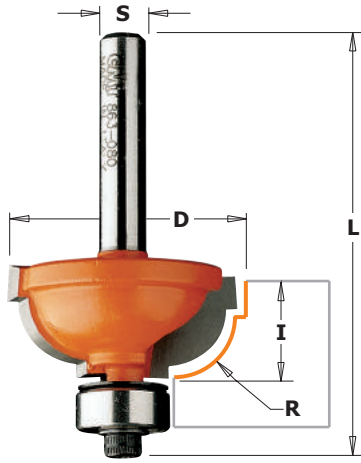

## 7/8/963 - 7/8/964

The cavetto bit cuts beautiful, traditional profiles, but you may also use just a portion of the bit to cut a more simple and cleaner cove edge. This bit adds a special touch to furniture pieces by making traditional cove profiles with top and bottom fillet grooves in any kind of wood and wood composites.

**SHOP TIPS:** undersized bearing to use after resharpening.

**791.062.00** Ø9,3 replace bearing 791.002.00 (Ø9,5) after resharpening

**791.063.00** Ø12,5 replace bearing 791.003.00 (Ø12,7) after resharpening

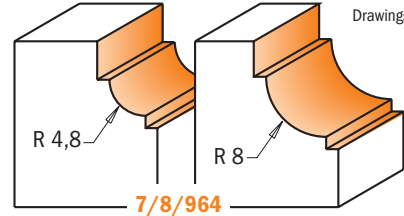
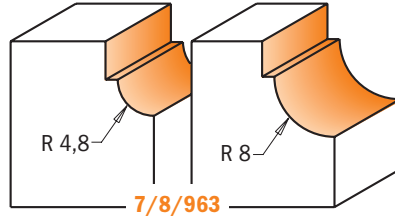

Drawings are 1:1 scale

R mm	D mm	I mm	L mm		ORDER NO. S=Ø6mm	ORDER NO. S=Ø6,35mm	ORDER NO. S=Ø8mm	ORDER NO. S=Ø12mm	ORDER NO. S=Ø12,7mm	Spare parts			
4,8	25,4	11,5	54,6	10	<b>763.048.11</b>	<b>863.048.11</b>	<b>963.048.11</b>						
4,8	25,4	11,5	60,9	10				<b>963.548.11</b>	<b>863.548.11</b>	990.423.00	791.003.00	990.058.00	991.057.00
8	31,7	14,3	56,9	10	<b>763.080.11</b>	<b>863.080.11</b>	<b>963.080.11</b>			990.423.00	791.003.00	990.058.00	991.057.00
8	31,7	14,3	63	10				<b>963.580.11</b>	<b>863.580.11</b>	990.423.00	791.003.00	990.058.00	991.057.00
4,8	25,4	11,5	52,8	10	<b>764.048.11</b>	<b>864.048.11</b>	<b>964.048.11</b>			990.422.00	791.002.00	990.058.00	991.057.00
4,8	25,4	11,5	59,1	10				<b>964.548.11</b>	<b>864.548.11</b>	990.422.00	791.002.00	990.058.00	991.057.00
8	31,7	14,3	55,1	10	<b>764.080.11</b>	<b>864.080.11</b>	<b>964.080.11</b>			990.422.00	791.002.00	990.058.00	991.057.00
8	31,7	14,3	61	10				<b>964.580.11</b>	<b>864.580.11</b>	990.422.00	791.002.00	990.058.00	991.057.00

# Ovolo Bits

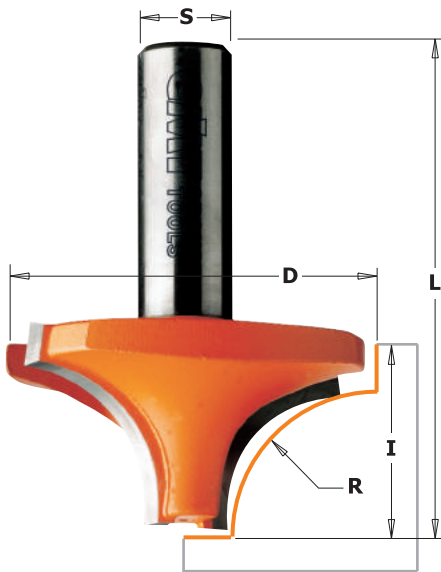

## 7/8/927

CMT put the work capacity of several different bits all into one. The perfect bit for furniture makers, the CMT ovolo allows you to make beautiful beadwork, edgework and veins. Use these bits on automated router systems or with a fence to produce a wide variety of single and double bead profiles and roundovers like those illustrated below by simply adjusting the height or depth of the cut.

**SAFETY TIPS:** pay particular attention to never rush the job when using a large profile bit. Mill pieces with a fence mounted on the work table to ensure maximum protection.

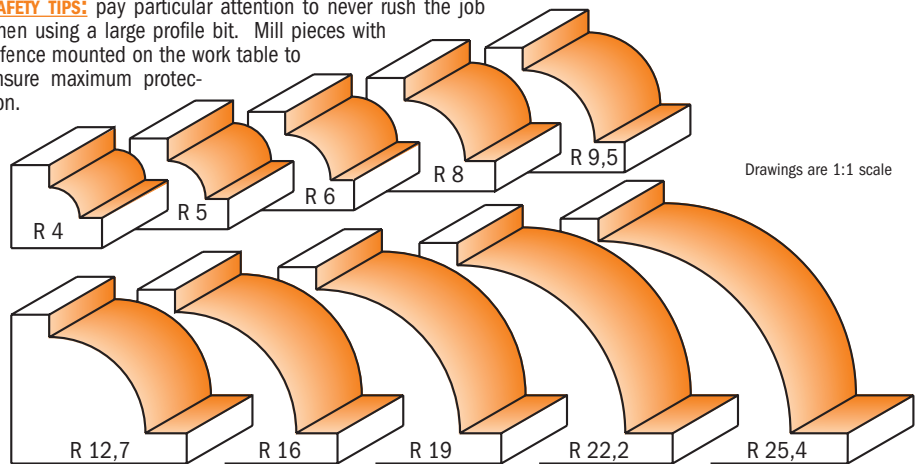

Drawings are 1:1 scale

R mm	D mm	I mm	L mm		ORDER NO. S=Ø6mm	ORDER NO. S=Ø6,35mm	ORDER NO. S=Ø8mm	ORDER NO. S=Ø12mm	ORDER NO. S=Ø12,7mm
4	19	12	43,8	10	<b>727.040.11</b>			<b>927.040.11</b>	
5	21	12	43,8	10	<b>727.050.11</b>	<b>827.050.11</b>	<b>927.050.11</b>		
6	23	12	43,8	10	<b>727.060.11</b>	<b>827.060.11</b>	<b>927.060.11</b>		
6	23	12	50,1	10					<b>827.560.11</b>
8	28,6	12,7	44,5	10	<b>727.080.11</b>			<b>927.080.11</b>	
9,5	31,7	15,8	47,6	10	<b>727.095.11</b>	<b>827.095.11</b>	<b>927.095.11</b>		
9,5	31,7	15,8	54	10				<b>927.595.11</b>	<b>827.595.11</b>
12,7	38,1	19	50,8	10		<b>827.127.11</b>			
12,7	38,1	19	57,1	10				<b>927.627.11</b>	<b>827.627.11</b>
16	44,5	22,2	60,3	10				<b>927.660.11</b>	<b>827.660.11</b>
19	50,8	25,4	63,5	10				<b>927.690.11</b>	<b>827.690.11</b>
22,2	57,1	28,5	66,6	5				<b>927.722.11</b>	<b>827.722.11</b>
25,4	63,5	33,3	71,4	5				<b>927.754.11</b>	<b>827.754.11</b>



# Beading Bits

## 7/8/939



Beading bits are similar to the roundover profile, but a smaller bearing produces a delicate inset at the base of the cut, giving you an extra decorative option. For a beading profile (code **7/8/939**) simply change the bearing (**791.002.00**) on your roundover bits (code **7/8/938**).

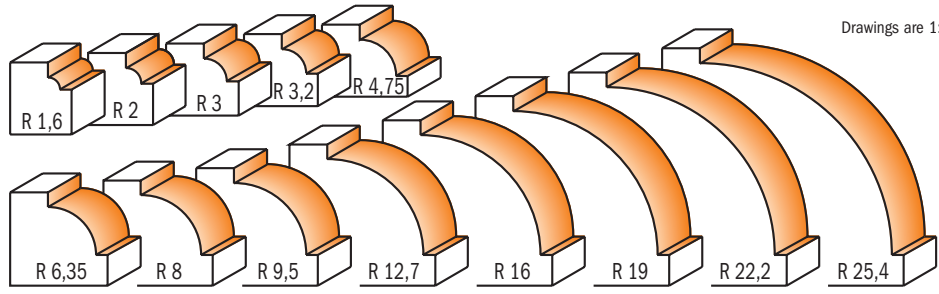
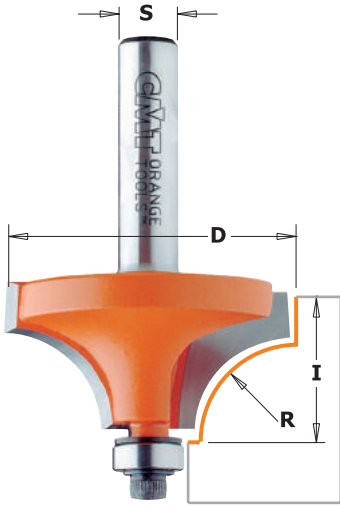

Drawings are 1:1 scale

\*Use only on router table

R mm	D mm	I mm		ORDER NO. S=Ø6mm	ORDER NO. S=Ø6,35mm	ORDER NO. S=Ø8mm	ORDER NO. S=Ø12mm	ORDER NO. S=Ø12,7mm	Spare parts							
1,6	15,9	12,7	10	<b>739.160.11</b>	<b>839.160.11</b>	<b>939.160.11</b>							990.422.00	791.002.00	990.058.00	991.057.00
2	16,7	12,7	10			<b>939.167.11</b>							990.422.00	791.002.00	990.058.00	991.057.00
3	18,7	12,7	10			<b>939.187.11</b>							990.422.00	791.002.00	990.058.00	991.057.00
3,2	19,1	12,7	10	<b>739.190.11</b>	<b>839.190.11</b>	<b>939.190.11</b>							990.422.00	791.002.00	990.058.00	991.057.00
4,75	22,2	12,7	10	<b>739.222.11</b>	<b>839.222.11</b>	<b>939.222.11</b>							990.422.00	791.002.00	990.058.00	991.057.00
6,35	25,4	12,7	10	<b>739.254.11</b>	<b>839.254.11</b>	<b>939.254.11</b>	<b>939.754.11</b>	<b>839.754.11</b>					990.422.00	791.002.00	990.058.00	991.057.00
8	28,6	12,7	10	<b>739.285.11</b>	<b>839.285.11</b>	<b>939.285.11</b>							990.422.00	791.002.00	990.058.00	991.057.00
9,5	31,7	16	10	<b>739.317.11</b>	<b>839.317.11</b>	<b>939.317.11</b>	<b>939.817.11</b>	<b>839.817.11</b>					990.422.00	791.002.00	990.058.00	991.057.00
12,7	38,1	19	10	<b>739.380.11</b>	<b>839.380.11</b>	<b>939.380.11</b>	<b>939.880.11</b>	<b>839.880.11</b>					990.422.00	791.002.00	990.058.00	991.057.00
16	44,5	22	10		<b>839.445.11</b>	<b>939.445.11</b>	<b>939.945.11</b>	<b>839.945.11</b>					990.422.00	791.002.00	990.058.00	991.057.00
19	50,8	25,4	10				<b>939.990.11</b>	<b>839.990.11</b>					990.422.00	791.002.00	990.058.00	991.057.00
22,2	57,1	28,5	5				<b>939.991.11</b>	<b>839.991.11</b>					990.422.00	791.002.00	990.058.00	991.057.00
25,4	63,5	33,3	5				<b>939.992.11*</b>	<b>839.992.11*</b>					990.422.00	791.002.00	990.058.00	991.057.00

# Roundover Bits with Insert Knives

## 661.11



Roundover bits with two replaceable knives fixed by special Torx screws. The blades are profiled on 2 sides and increase the efficiency of your work with laminates. Roundover bits are equipped with ball bearing guides. For precision work on laminates. Radius R2 or R3 is for rounded 2mm or 3mm ABS edges. Radius R5 is for quick rounded edges in hard wood or MDF. For use on portable Routers.

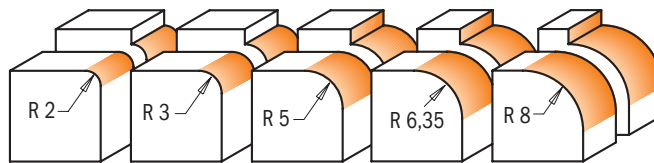
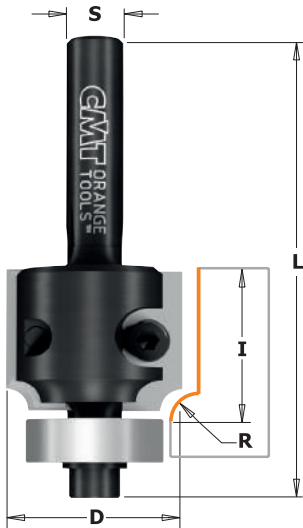

Drawings are 1:1 scale

CORRECT KNIFE POSITIONING

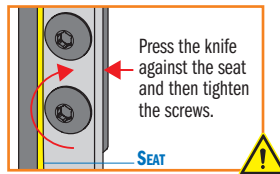

## 661.41

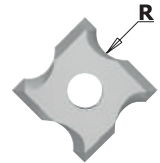

Optional

R=1mm	<b>790.010.04</b>
R=1,5mm	<b>790.015.04</b>
R=2mm	<b>790.020.04</b>
R=3mm	<b>790.030.04</b>

R mm	D mm	I mm	L mm		ORDER NO. S=Ø6,35mm	ORDER NO. S=Ø8mm	ORDER NO. S=Ø12,7mm	Spare parts								
2	27		57,5	10	<b>661.021.41</b>	<b>661.020.41</b>							790.020.04	990.078.00	991.061.00	791.003.00
3	27		57,5	10	<b>661.031.41</b>	<b>661.030.41</b>							790.030.04	990.078.00	991.061.00	791.003.00
5	28,8	19,5	64	10	<b>661.051.11</b>	<b>661.050.11</b>		790.050.00					990.076.00	991.061.00	791.007.00	
6,35	28,5	24	67	10	<b>661.064.11</b>	<b>661.063.11</b>		790.064.00					990.075.00	991.061.00	791.006.00	
8	31,8	24	67	10		<b>661.080.11</b>		790.080.00					990.075.00	991.061.00	791.006.00	
8	31,8	24	77	10			<b>661.581.11</b>	790.080.00					990.075.00	991.061.00	791.006.00	

<b>Spare parts</b>	990.400.00 M3 shield	990.410.00 M4 shield	990.423.00 Shield for 12,7mm bearing
	990.051.00 M3x6mm TCEI screw	990.052.00 M4x6mm TCEI screw	990.058.00 1/8"x3/8"x1/2" TCEI screw
	991.062.00 2,5mm hex key	991.067.00 3mm hex key	991.057.00 3/32" hex key

# Roundover Bits



## 7/8/938

All CMT roundover bits have a 12,7mm bearing diameter with the exception of the radius 28,6mm and 31,7mm bits which have a 19mm bearing diameter. You have 13 different radii to choose from, the majority having 5 shank diameter options. All bits are made of Fatigue Proof™ steel and have carbide-tipped cutting edges.

**BE SURE** to keep the black bearing washer right side up to correspond with the bearing rotation when reassembling the bearing. Improper reassembly can cause the bit to unscrew.

**SHOP TIPS:** the CMT 1.6mm radius roundover bit is excellent for finishing laminates. Virtually eliminates the filing required when using conventional trim bits.

**SAFETY TIPS:** use caution when working with large diameter bits and make more than one pass to gradually remove stock. Pay particular attention when routing small pieces; and always rout on a router table equipped with a fence.

**SHOP TIPS: undersized bearing to use after resharpening.**  
791.063.00 Ø12,5 replace bearing 791.003.00 (Ø12,7) after resharpening

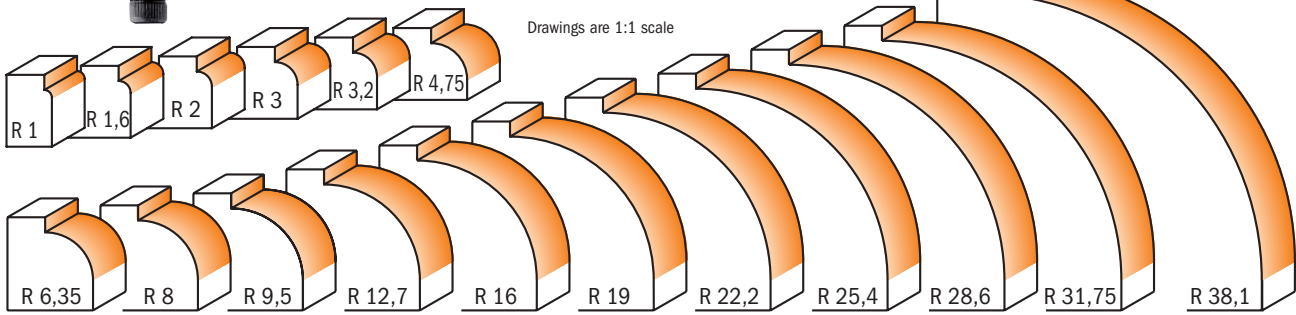
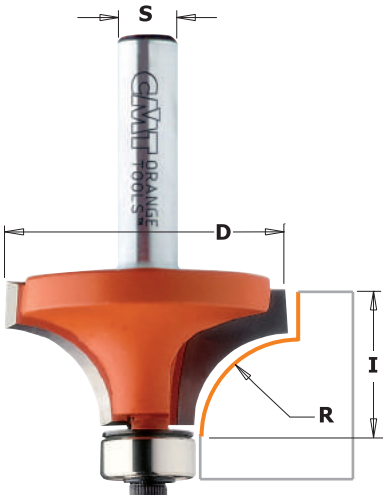

Drawings are 1:1 scale

R mm	D mm	I mm	Box	ORDER NO. S=Ø6mm	ORDER NO. S=Ø6,35mm	ORDER NO. S=Ø8mm	ORDER NO. S=Ø12mm	ORDER NO. S=Ø12,7mm	Spare parts			
1	14,7	10	10		<b>838.147.11</b>	<b>938.147.11</b>			990.422.00	791.044.00	990.058.00	991.057.00
1,6	15,9	12,7	10	<b>738.160.11</b>	<b>838.160.11</b>	<b>938.160.11</b>			990.423.00	791.003.00	990.058.00	991.057.00
2	16,7	12,7	10	<b>738.167.11°</b>		<b>938.167.11°</b>			990.422.00	791.044.00	990.058.00	991.057.00
2	16,7	12,7	10		<b>838.167.11</b>				990.423.00	791.003.00	990.058.00	991.057.00
3	18,7	12,7	10	<b>738.187.11°</b>		<b>938.187.11°</b>			990.422.00	791.044.00	990.058.00	991.057.00
3	18,7	12,7	10		<b>838.187.11</b>				990.423.00	791.003.00	990.058.00	991.057.00
3,2	19,1	12,7	10	<b>738.190.11</b>	<b>838.190.11</b>	<b>938.190.11</b>			990.423.00	791.003.00	990.058.00	991.057.00
4,75	22,2	12,7	10	<b>738.222.11</b>	<b>838.222.11</b>	<b>938.222.11</b>			990.423.00	791.003.00	990.058.00	991.057.00
6,35	25,4	12,7	10	<b>738.254.11</b>	<b>838.254.11</b>	<b>938.254.11</b>	<b>938.754.11</b>	<b>838.754.11</b>	990.423.00	791.003.00	990.058.00	991.057.00
8	28,6	12,7	10	<b>738.285.11</b>	<b>838.285.11</b>	<b>938.285.11</b>			990.423.00	791.003.00	990.058.00	991.057.00
9,5	31,7	16	10	<b>738.317.11</b>	<b>838.317.11</b>	<b>938.317.11</b>	<b>938.817.11</b>	<b>838.817.11</b>	990.423.00	791.003.00	990.058.00	991.057.00
12,7	38,1	19	10	<b>738.380.11</b>	<b>838.380.11</b>	<b>938.380.11</b>	<b>938.880.11</b>	<b>838.880.11</b>	990.423.00	791.003.00	990.058.00	991.057.00
16	44,5	22	10		<b>838.445.11</b>	<b>938.445.11</b>	<b>938.945.11</b>	<b>838.945.11</b>	990.423.00	791.003.00	990.058.00	991.057.00
19	50,8	25,4	10				<b>938.990.11</b>	<b>838.990.11</b>	990.423.00	791.003.00	990.058.00	991.057.00
22,2	57,1	28,5	5				<b>938.991.11</b>	<b>838.991.11</b>	990.423.00	791.003.00	990.058.00	991.057.00
25,4	63,5	33,3	5				<b>938.992.11*</b>	<b>838.992.11*</b>	990.423.00	791.003.00	990.058.00	991.057.00
28,6	76,2	38,1	5				<b>938.993.11*</b>	<b>838.993.11*</b>	541.550.00	791.004.00	990.058.00	991.057.00
31,75	82,5	44,4	5				<b>938.994.11*</b>	<b>838.994.11*</b>	541.550.00	791.004.00	990.058.00	991.057.00
38,1	88,9	44,4	5				<b>938.996.11*</b>	<b>838.996.11*</b>	990.423.00	791.003.00	990.058.00	991.057.00

\*Use only on router table

°791.044.00 Delrin® Bearing

## Roundover Set

### 838

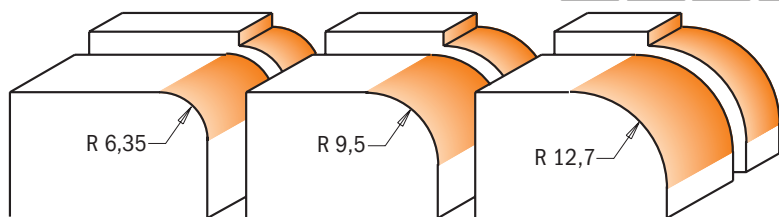

Drawings are 1:1 scale

CMT's roundover sets give you the maximum flexibility for all of your projects by putting the most requested diameters in one package. Available in 12,7mm and 6,35mm shanks. Roundover radii are 6,35mm, 9,5mm and 12,7mm. These versatile bits are always in demand - the simple clean lines of a smooth roundover edge can be used in a wide variety of applications from picture frames to table and counter tops.

DESCRIPTION	Box	ORDER NO. S=Ø6,35mm	ORDER NO. S=Ø12,7mm
Roundover set	5	<b>838.001.11</b>	<b>838.501.11</b>

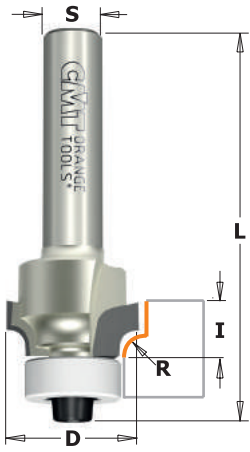

**938 XTREME**



These new super duty DP (polycrystalline diamond) bits represent the ultimate in the extensive line of CMT rounding over bits. Investing in CMT DP rounding bits means saving time and money, as they last 40 times longer than conventional bits. You could work a wide variety of tough, abrasive materials including composites, particleboard, MDF (both raw or with melamine), veneer and hardwoods.

**Excellent for Corner Rounding:**

- Aluminum
- Aluminum Composites
- Aluminum Composite Material (ACM)
- Composites
- Composite Panels
- Custom Composite Materials
- Fiberglass
- Fiberglass PCB Board
- Fiberglass Reinforced Composites
- Fiber-Reinforced Urethane
- Fiber-Reinforced Structural Foam Floors
- Hard and Soft Wood
- Lightweight Composites
- MDF
- Plastic

**Benefits of Diamond Technology**

- Harder cutting edge provides higher resistance to wear
- Cut thousands of meters more than carbide without changing tool, saving setup time
- Optimized machine tool efficiency
- Quality of finish is often significantly improved

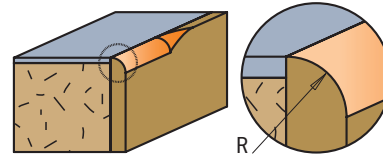

R mm	D mm	I mm		ORDER NO. S=Ø8mm
2	16,7	8	10	<b>938.167.61</b>
3	18,7	8	10	<b>938.187.61</b>

Spare parts			
990.422.00	791.044.00	990.058.00	991.057.00
990.422.00	791.044.00	990.058.00	991.057.00

791.044.00 Delrin® bearing

Decorative Ogee Bits



**8/965.905**



**8/965.903**  
**8/965.904**

**8/965.9**

Enhance your doors and drawer fronts and leave your visitors amazed! The cutting edges on these ogee bits are carbide-tipped for effective, smooth and eye-catching work.

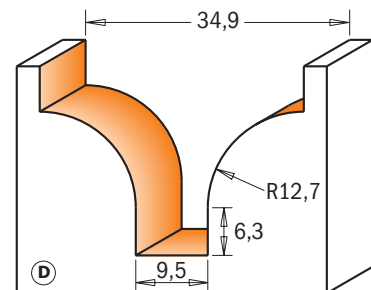
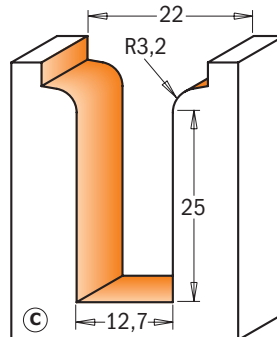
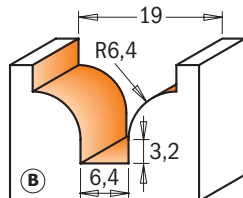

Drawings are 1:1 scale

D mm	d mm	R mm	I mm	L mm	PROFILE		ORDER NO. S=Ø12mm	ORDER NO. S=Ø12,7mm
19	6,4	6,4	13	51	B	10	<b>965.903.11</b>	<b>865.903.11</b>
22	12,7	3,2	31,7	69,8	C	10	<b>965.905.11</b>	<b>865.905.11</b>
34,9	9,5	12,7	25	65,5	D	10	<b>965.904.11</b>	<b>865.904.11</b>



## Decorative Beading Bits

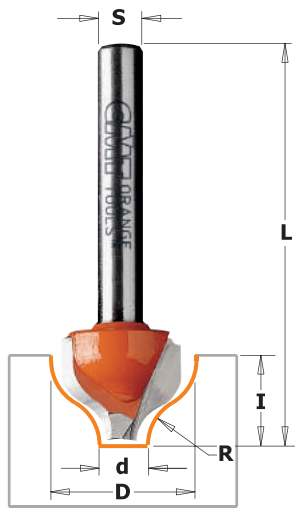

### 7/8/965

This new CMT bit produces a classic single or double-edged bead. Ideal for creating a marked decorative effect on panel, door and drawer work.

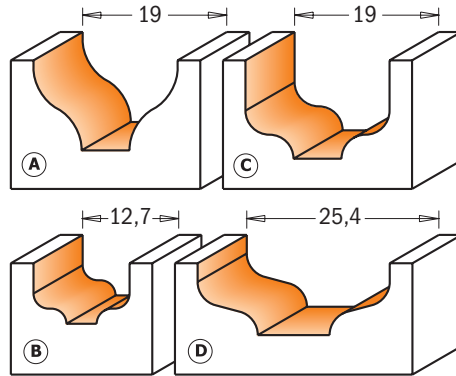

Drawings are 1:1 scale

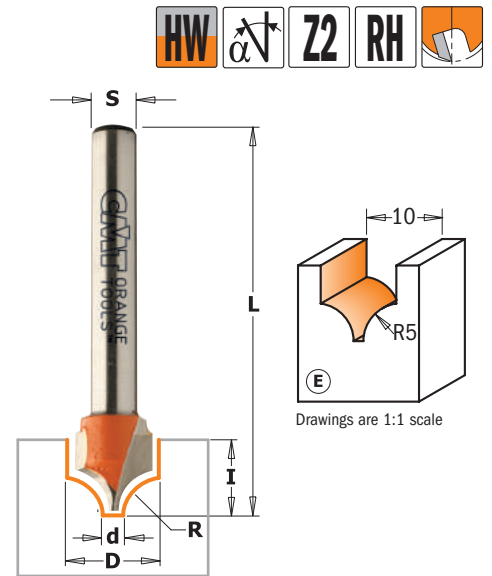

Drawings are 1:1 scale

D mm	d mm	R mm	I mm	L mm	PROFILE		ORDER NO. S=Ø6mm	ORDER NO. S=Ø6,35mm	ORDER NO. S=Ø8mm	ORDER NO. S=Ø12mm	ORDER NO. S=Ø12,7mm
19	6,35	6,4	11	50,8	A	10	<b>765.001.11</b>	<b>865.001.11</b>	<b>965.001.11</b>	<b>965.501.11</b>	<b>865.501.11</b>
12,7	4	2	8	51	B	10		<b>865.002.11</b>	<b>965.002.11</b>		
19	6,35	3,2	13	68	C	10				<b>965.503.11</b>	<b>865.503.11</b>
25,4	9,5	3,2	9,5	49	D	10				<b>965.504.11</b>	<b>865.504.11</b>
10	1,3	5	10	50	E	10	<b>765.402.11</b>	<b>865.402.11</b>	<b>965.402.11</b>		

## Classical Bead Bits

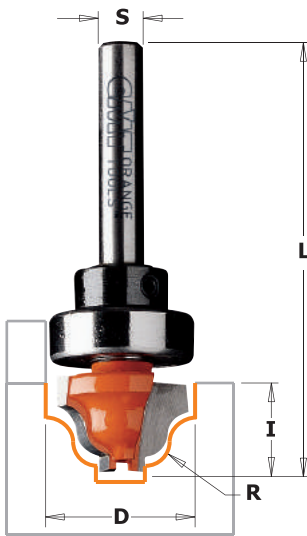

### 7/8/965B

This bit gives you even more decorative possibilities for panel and edge work. The bit design offers a wide flat bottom cut and a longer shank allows for a greater depth in the detail of the profile.

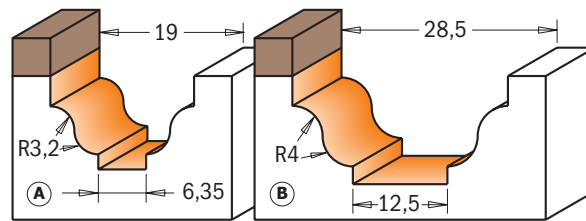

Drawings are 1:1 scale

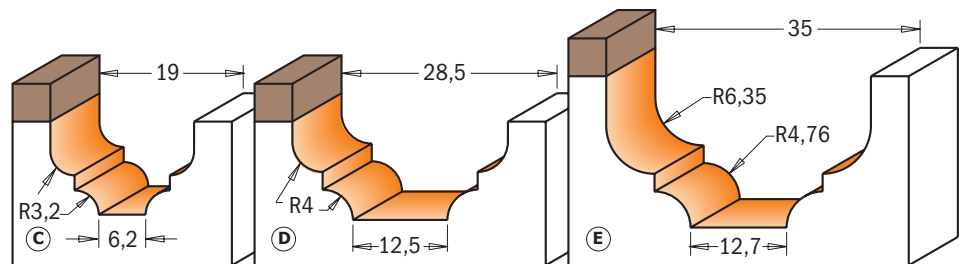

D mm	R mm	I mm	L mm	PROFILE		ORDER NO. S=Ø6mm	ORDER NO. S=Ø6,35mm	ORDER NO. S=Ø8mm	ORDER NO. S=Ø12mm	ORDER NO. S=Ø12,7mm	Spare parts		
19	3,2	12,3	54	A	10	<b>765.201.11B</b>					791.007.00	541.003.00	991.056.00
19	3,2	12,3	54	A	10		<b>865.201.11B</b>				791.004.00	541.001.00	991.056.00
28,6	4	14,3	58,8	B	10			<b>965.202.11B</b>			791.027.00	541.002.00	991.056.00
28,6	4	14,3	58,8	B	10				<b>965.702.11B</b>		791.027.00	541.005.00	991.056.00
28,6	4	14,3	58,8	B	10					<b>865.702.11B</b>	791.027.00	541.002.00	991.056.00
19	3,2	12,3	54	C	10	<b>765.301.11B</b>					791.007.00	541.003.00	991.056.00
19	3,2	12,3	54	C	10		<b>865.301.11B</b>				791.004.00	541.001.00	991.056.00
28,6	4	13,3	58	D	10			<b>965.302.11B</b>		<b>865.802.11B</b>	791.027.00	541.002.00	991.056.00
28,6	4	13,3	58	D	10				<b>965.802.11B</b>		791.027.00	541.005.00	991.056.00
34,9	4,76 - 6,35	18,5	66,1	E	10			<b>965.303.11B</b>			791.031.00	541.004.00	991.056.00
34,9	4,76 - 6,35	18,5	66,1	E	10					<b>865.803.11B</b>	791.029.00	541.002.00	991.056.00

Spare parts 990.005.00 M3x3mm TSEI screw

# Plunge Ogee Bits

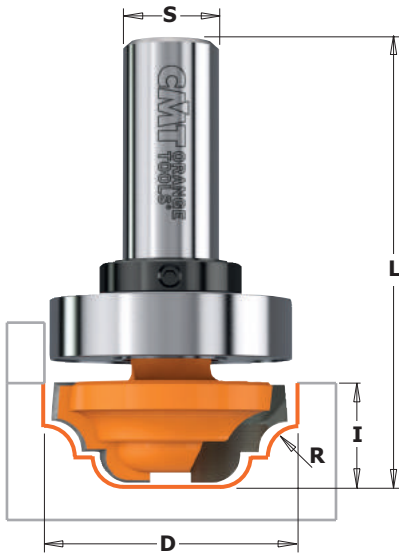

## 7/8/948B

You will never run out of ideas with this creative bit. Add a classic touch to any edge or highlight door fronts and panels with decorative layered effects.

For even more options, try the CMT plunge ogee with bearing guide for pattern following.

For more CMT ogee profile options, choose among plunge ogee bits equipped with a top bearing.

Excellent for achieving accurate decorative work and guaranteed for long-lasting performance.

## 7/8/948

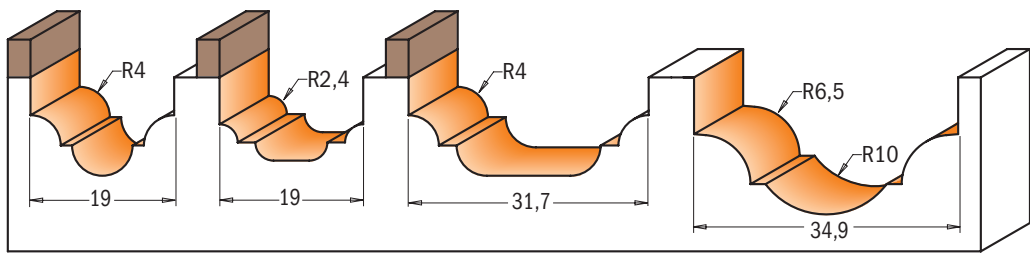

Drawings are 1:1 scale

D mm	R mm	I mm	L mm		ORDER NO. S=∅6mm	ORDER NO. S=∅6,35mm	ORDER NO. S=∅8mm	ORDER NO. S=∅12mm	ORDER NO. S=∅12,7mm
19	4	13	51,1	10	<b>748.190.11</b>	<b>848.190.11</b>	<b>948.190.11</b>		
19	2,4	12	53	10	<b>748.191.11</b>	<b>848.191.11</b>	<b>948.191.11</b>		
31,7	4	13	58	10			<b>948.317.11</b>	<b>948.817.11</b>	<b>848.817.11</b>
34,9	6,5-10	18	68	10				<b>948.850.11</b>	<b>848.850.11</b>
<b>With Top Bearing</b>									
19	4	13	51,1	10	<b>748.190.11B</b>				
19	4	13	51,1	10		<b>848.190.11B</b>			
19	2,4	12	53	10	<b>748.191.11B</b>				
19	2,4	12	53	10		<b>848.191.11B</b>			
31,7	4	13	58	10			<b>948.317.11B</b>		
31,7	4	13	58	10				<b>948.817.11B</b>	
31,7	4	13	58	10					<b>848.817.11B</b>

**Spare parts**

791.007.00	541.003.00	991.056.00
791.004.00	541.001.00	991.056.00
791.007.00	541.003.00	991.056.00
791.004.00	541.001.00	991.056.00
791.015.00	541.002.00	991.056.00
791.015.00	541.005.00	991.056.00
791.015.00	541.002.00	991.056.00

**Spare parts** 990.005.00 M3x3mm TSEI screw

# Decorative Ogee Bits

## 7/8/965.1

This new CMT bit produces a classic single or double edged bead. Ideal for creating a marked decorative effect on panel, door and drawer work.

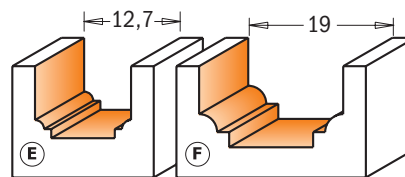
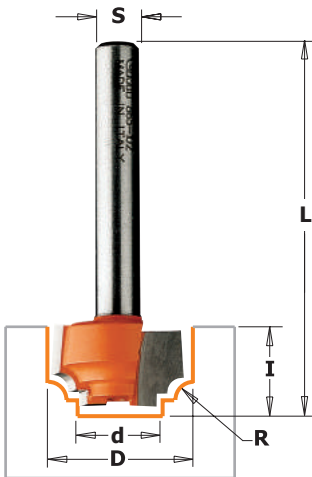

Drawings are 1:1 scale

D mm	d mm	R mm	I mm	L mm	PROFILE		ORDER NO. S=∅6mm	ORDER NO. S=∅6,35mm	ORDER NO. S=∅8mm
12,7	8,4	1,2	12,7	50,8	E	10	<b>765.101.11</b>	<b>865.101.11</b>	<b>965.101.11</b>
19	11,1	2,4	11	50,8	F	10	<b>765.102.11</b>	<b>865.102.11</b>	<b>965.102.11</b>

# Roman Ogee Bits

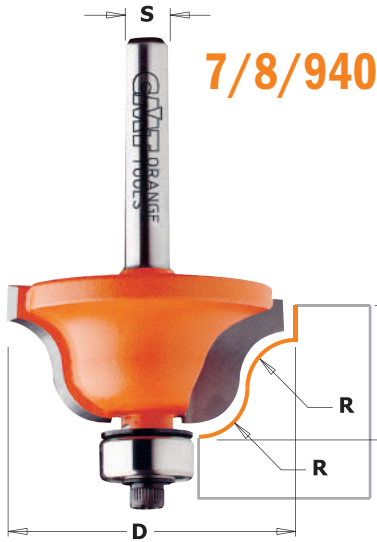

**7/8/940**

The roman ogee may be the most popular edge treatment in woodworking, and it is certainly one of the most beautiful. This bit includes all CMT bit features and produces a perfect rendition of classic design.

**SHOP TIPS:** for best results, multiple passes are recommended.

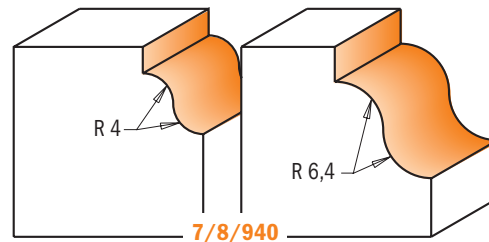

**7/8/940**

Drawings are 1:1 scale

This bit takes the Roman Ogee a step further. The horizontal bead adds style and elegance to the traditional shape contour.

**SHOP TIPS:** for best results, multiple passes are recommended.

**7/8/941**

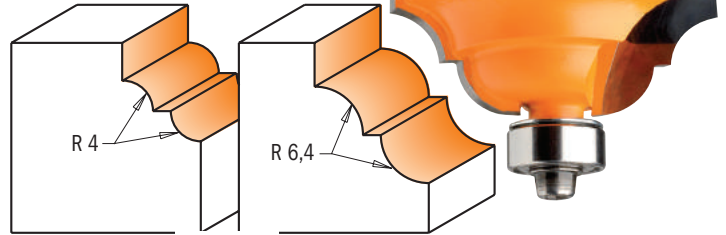

**7/8/941**

R mm	D mm	I mm		ORDER NO. S=Ø6mm	ORDER NO. S=Ø6,35mm	ORDER NO. S=Ø8mm	ORDER NO. S=Ø12mm	ORDER NO. S=Ø12,7mm
4	28,7	11,5	10	<b>740.270.11</b>	<b>840.270.11</b>	<b>940.270.11</b>	<b>940.770.11</b>	<b>840.770.11</b>
6,4	38,1	17,3	10	<b>740.350.11</b>	<b>840.350.11</b>	<b>940.350.11</b>	<b>940.850.11</b>	<b>840.850.11</b>
4	33,4	13	10	<b>741.285.11</b>	<b>841.285.11</b>	<b>941.285.11</b>	<b>941.785.11</b>	<b>841.785.11</b>
6,4	42,8	18,5	10	<b>741.380.11</b>	<b>841.380.11</b>	<b>941.380.11</b>	<b>941.880.11</b>	<b>841.880.11</b>

Spare parts			
990.423.00	791.003.00	990.058.00	991.057.00
990.423.00	791.003.00	990.058.00	991.057.00
990.423.00	791.003.00	990.058.00	991.057.00
990.423.00	791.003.00	990.058.00	991.057.00

**SHOP TIPS:** oversized bearing to use after resharpening.  
**791.063.00** Ø12,5 replace bearing 791.003.00 (Ø12,7) after resharpening

# Classical Ogee Bits

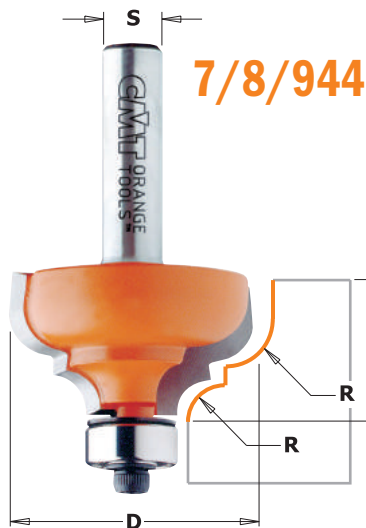

**7/8/944**

CMT's classical ogee bits feature an inverted ogee profile, with the concave edge adjacent to the upper surface of the workpiece. A vertical bead was added to separate the curves and creates an eye-catching shape.

**SHOP TIPS:** for best results, multiple passes are recommended.

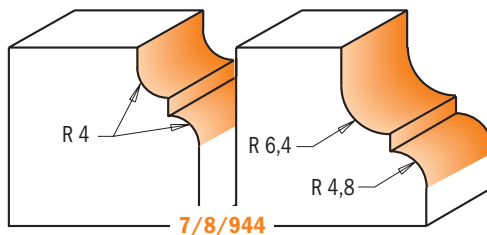

**7/8/944**

Drawings are 1:1 scale

This profile includes a horizontal bead along the bottom of the profile adding a decorative detail to the traditional ogee design.

**SHOP TIPS:** for best results, multiple passes are recommended.

**7/8/945**

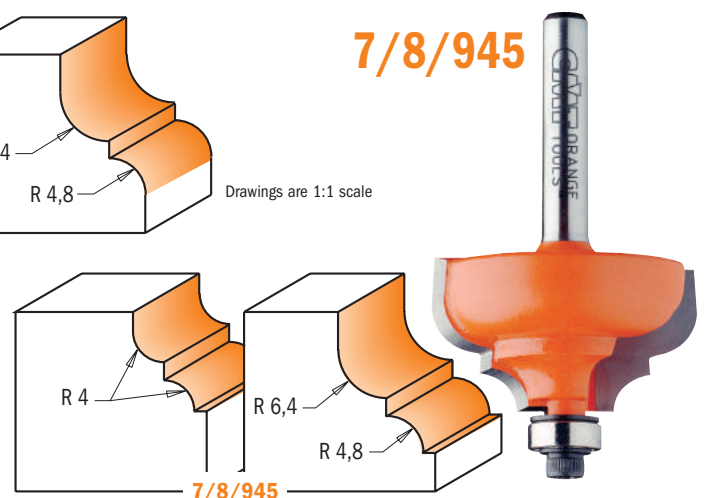

**7/8/945**

R mm	D mm	I mm		ORDER NO. S=Ø6mm	ORDER NO. S=Ø6,35mm	ORDER NO. S=Ø8mm	ORDER NO. S=Ø12mm	ORDER NO. S=Ø12,7mm
4	28,7	13	10	<b>744.287.11</b>	<b>844.287.11</b>	<b>944.287.11</b>	<b>944.787.11</b>	<b>844.787.11</b>
6,4-4,8	35	18,5	10	<b>744.350.11</b>	<b>844.350.11</b>	<b>944.350.11</b>	<b>944.850.11</b>	<b>844.850.11</b>
4	28,7	13	10	<b>745.287.11</b>	<b>845.287.11</b>	<b>945.287.11</b>	<b>945.787.11</b>	<b>845.787.11</b>
6,4-4,8	35	18,5	10	<b>745.350.11</b>	<b>845.350.11</b>	<b>945.350.11</b>	<b>945.850.11</b>	<b>845.850.11</b>

Spare parts			
990.423.00	791.003.00	990.058.00	991.057.00
990.423.00	791.003.00	990.058.00	991.057.00
990.422.00	791.002.00	990.058.00	991.057.00
990.422.00	791.002.00	990.058.00	991.057.00

**SHOP TIPS:** oversized bearing to use after resharpening.  
**791.062.00** Ø9,3 replace bearing 791.002.00 (Ø9,5) after resharpening  
**791.063.00** Ø12,5 replace bearing 791.003.00 (Ø12,7) after resharpening



# Ogee with Fillet Bits

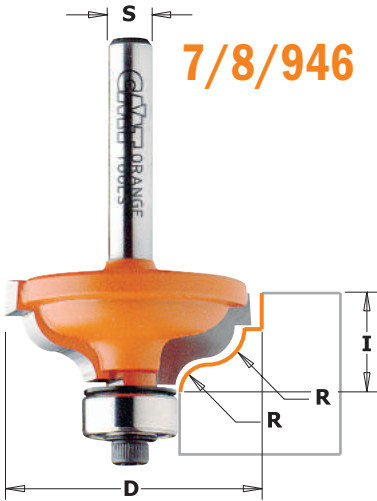

**7/8/946**

Take a complete assortment of CMT ogee bits into your shop. These bits feature micrograin carbide edges, high strength steel and the trademarked orange non-stick PTFE coating.

**SHOP TIPS:** for best results, multiple passes are recommended.

For a more-detailed profile, this bit adds an inset bead along the lower edge of the cut.

**SHOP TIPS:** for best results, multiple passes are recommended.

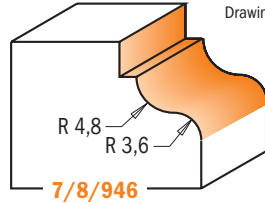

Drawings are 1:1 scale

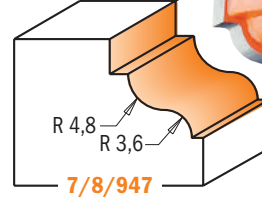

**7/8/947**



**7/8/947**

R mm	D mm	I mm		ORDER NO. S=Ø6mm	ORDER NO. S=Ø6,35mm	ORDER NO. S=Ø8mm	ORDER NO. S=Ø12mm	ORDER NO. S=Ø12,7mm
4,8-3,6	34,2	13	10	<b>746.325.11</b>	<b>846.325.11</b>	<b>946.325.11</b>	<b>946.825.11</b>	<b>846.825.11</b>
4,8-3,6	34,2	13	10	<b>747.325.11</b>	<b>847.325.11</b>	<b>947.325.11</b>	<b>947.825.11</b>	<b>847.825.11</b>

Spare parts

990.423.00	791.003.00	990.058.00	991.057.00
990.422.00	791.002.00	990.058.00	991.057.00

**SHOP TIPS:** oversized bearing to use after reshaping.

**791.062.00** Ø9,3 replace bearing 791.002.00 (Ø9,5) after reshaping

**791.063.00** Ø12,5 replace bearing 791.003.00 (Ø12,7) after reshaping

# Ogee Bits



**7/8/959**

These profiles are the mirror image of the traditional roman ogee. They add sharp defining details to the edges of cabinets and furniture, before rolling into a smooth convex shape.

**SHOP TIPS:** for best results, multiple passes are recommended.

These bits are identical to the 7/8/959 series with the addition of an inset bead along the lower edge.

**SHOP TIPS:** for best results, multiple passes are recommended.

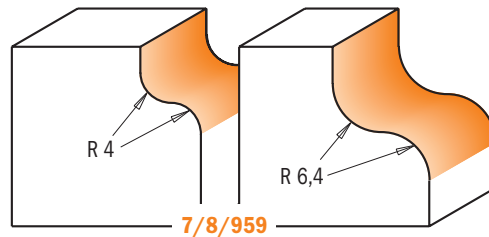

**7/8/959**

Drawings are 1:1 scale

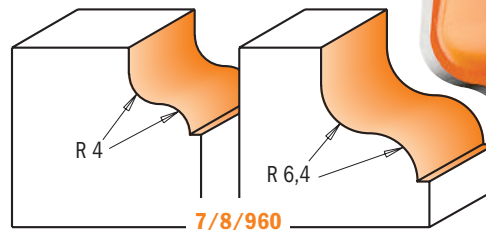

**7/8/960**



**7/8/960**

R mm	D mm	I mm		ORDER NO. S=Ø6mm	ORDER NO. S=Ø6,35mm	ORDER NO. S=Ø8mm	ORDER NO. S=Ø12mm	ORDER NO. S=Ø12,7mm
4	28,7	13	10	<b>759.040.11</b>	<b>859.040.11</b>	<b>959.040.11</b>	<b>959.540.11</b>	<b>859.540.11</b>
6,4	38,1	18	10	<b>759.064.11</b>	<b>859.064.11</b>	<b>959.064.11</b>	<b>959.564.11</b>	<b>859.564.11</b>
4	28,7	13	10	<b>760.040.11</b>	<b>860.040.11</b>	<b>960.040.11</b>	<b>960.540.11</b>	<b>860.540.11</b>
6,4	38,1	18	10	<b>760.064.11</b>	<b>860.064.11</b>	<b>960.064.11</b>	<b>960.564.11</b>	<b>860.564.11</b>

Spare parts

990.423.00	791.003.00	990.058.00	991.057.00
990.423.00	791.003.00	990.058.00	991.057.00
990.422.00	791.002.00	990.058.00	991.057.00
990.422.00	791.002.00	990.058.00	991.057.00

**SHOP TIPS:** oversized bearing to use after reshaping.

**791.062.00** Ø9,3 replace bearing 791.002.00 (Ø9,5) after reshaping

**791.063.00** Ø12,5 replace bearing 791.003.00 (Ø12,7) after reshaping



## 8/900.623

These CMT bits are ideal for making attractive edgework! Create a double 4,76mm (3/16") roundover profile, a double 45° bevel or even a mixed profile on your wood panels easily and in a cost-effective way! Interchangeable shims are included to allow for different stock thicknesses according to the board. To be used on table-mounted routers. Do not use these bits with hand-held power tools.

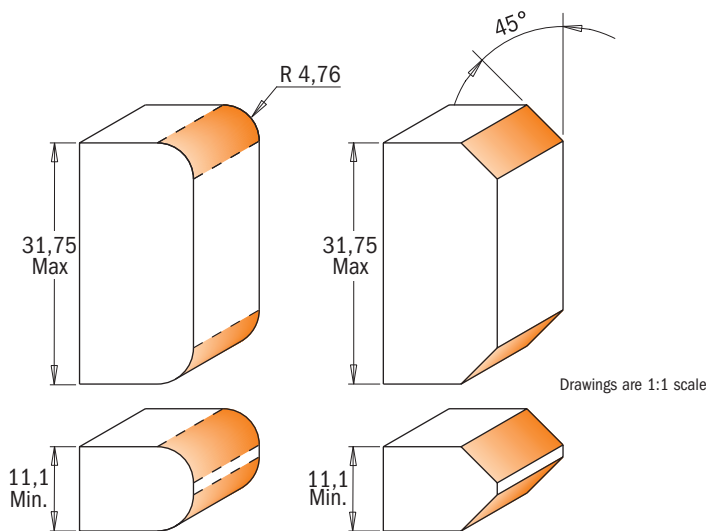

Drawings are 1:1 scale

D mm	T <sub>1</sub> mm	R mm	A	L mm		ORDER NO. S=Ø12mm	ORDER NO. S=Ø12,7mm
38,1	11,1 - 31,75	4,76	45°	100	10	<b>900.623.11</b>	
38,1	11,1 - 31,75	4,76	45°	100	10		<b>800.623.11</b>

### Spare parts

		45° R	R 45°	
924.137.00	791.037.00	822.029.11	822.030.11	990.020.00
824.137.00	791.037.00	822.029.11	822.030.11	990.020.00

Spare parts	541.500.00	3mm spacer	541.518.00	1mm spacer
	541.515.00	0,1mm spacer	541.519.00	5,8mm spacer
	541.517.00	0,5mm spacer		

# Adjustable Double Roundover Router Bits

## 8/900.622

Create awesome furnishing decorations with these new CMT bits! They provide a double 2mm (5/64") and 3mm (1/8") roundover profile on your wood panels easily and in a cost-effective way! Interchangeable shims are included to allow for different stock thicknesses according to the board. To be used on table-mounted routers. Do not use these bits with hand-held power tools.

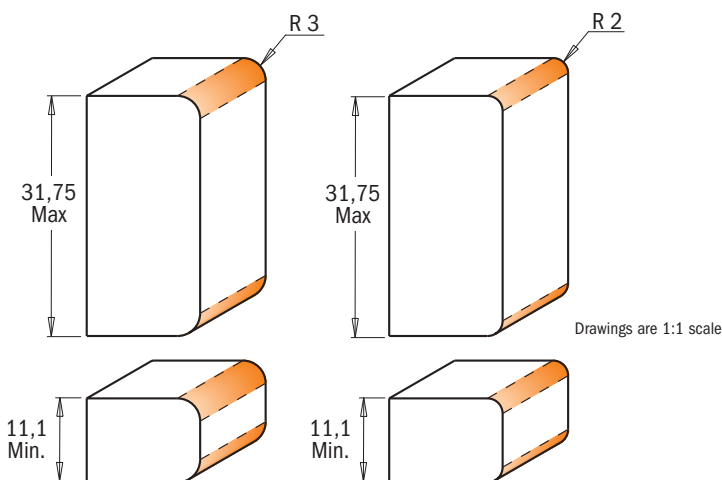
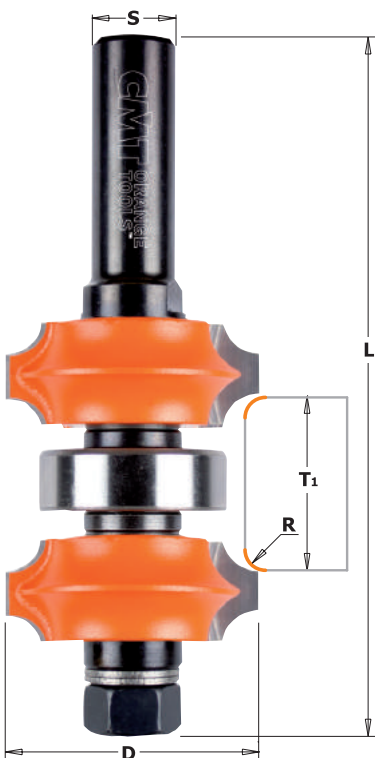

Drawings are 1:1 scale

D mm	T <sub>1</sub> mm	R mm	L mm		ORDER NO. S=Ø12mm	ORDER NO. S=Ø12,7mm
34	11,1 - 31,75	3 - 2	100	10	<b>900.622.11</b>	
34	11,1 - 31,75	3 - 2	100	10		<b>800.622.11</b>

### Spare parts

		R2 R3	R3 R2	
924.137.00	791.037.00	822.031.11	822.032.11	990.020.00
824.137.00	791.037.00	822.031.11	822.032.11	990.020.00

Spare parts	541.500.00	3mm spacer	541.516.00	0,3mm spacer
	541.501.00	4mm spacer	541.518.00	1mm spacer
	541.515.00	0,1mm spacer	541.519.00	5,8mm spacer

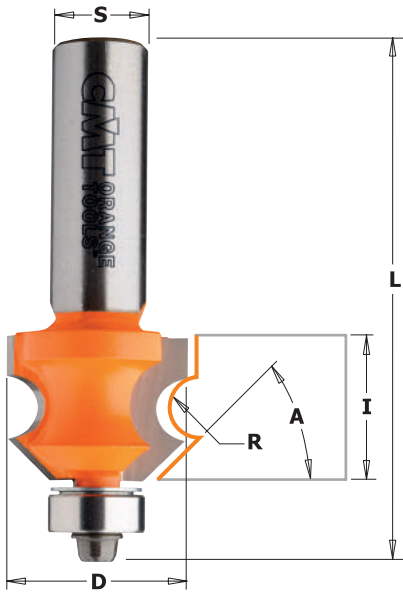

**8/961.6**



This new router bit designed for 19mm (3/4") thick stock is perfect for creating wainscots and panels on your walls. Simply create a 6,35mm (1/4") tongue-and-groove interlock with a CMT 8/900.626.11, then, with two passes mill an attractive traditional beadboard profile with this new bit. Perfect for cabinets, bookcase backings, ceiling and wall paneling.

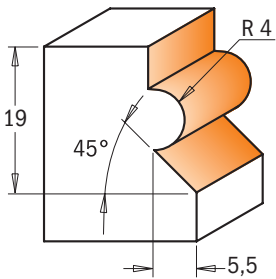
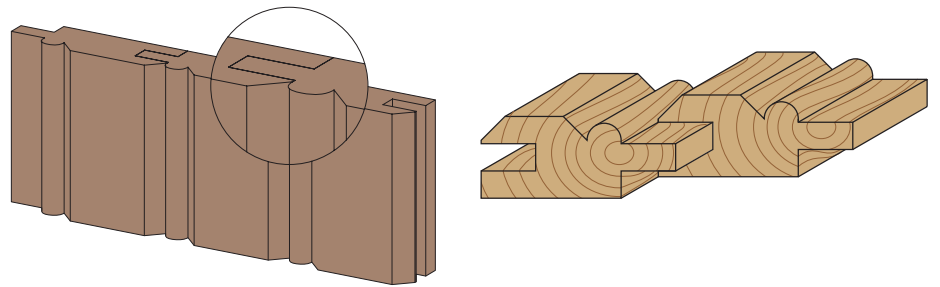

Drawing is 1:1 scale

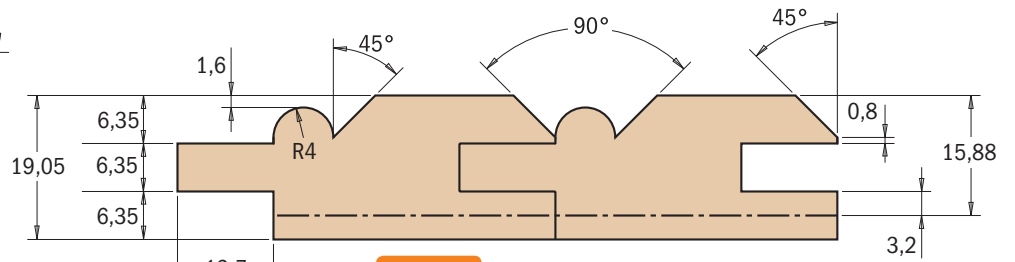

**Standard** with bearing Ø12,7mm (791.003.00)

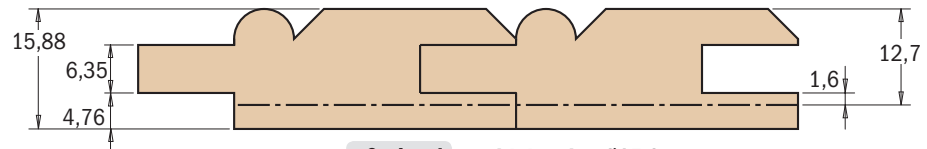

**Optional** with bearing Ø15,8mm (791.018.00)

D mm	I mm	R mm	A	L mm		ORDER NO. S=Ø12mm	ORDER NO. S=Ø12,7mm	Spare parts							
23,8	19,05	4	45°	67,7		961.601.11	861.601.11					990.423.00	791.003.00	990.058.00	991.057.00

**SHOP TIPS:** oversized bearing to use after resharpening. 791.063.00 Ø12,5 replace bearing 791.003.00 (Ø12,7) after resharpening

Corner Beading Bit with 45° Chamfer

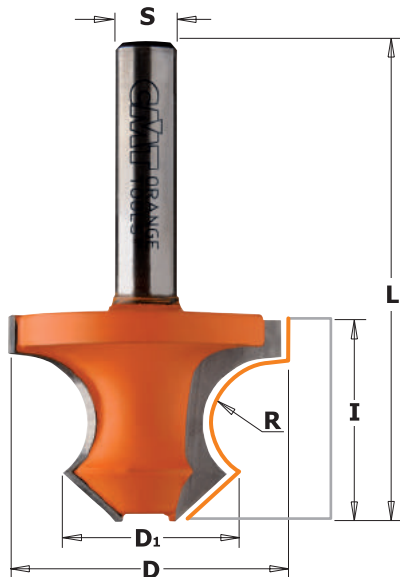

**954**



An innovative bit to create beautiful edges and corner beads.

**SAFETY TIPS:** to be used only on CNC machines or router tables equipped with a fence.

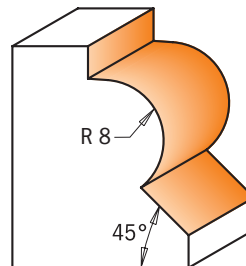

Drawing is 1:1 scale

D mm	D1 mm	I mm	R mm	L mm		ORDER NO. S=Ø8mm
36	22	25	8	60		954.080.11



# Bead & Bull Nose Bits



## 7/8/954

CMT's bull nose bits create elegantly finished edges on stair treads, window sills and shelves in one pass. Add a final touch by using a cutter with a bead diameter wider than the stock thickness. CMT bull nose bits have bead diameters from 6,35mm (1/4") to 25,4mm (1") and each bit features carbide-tipped cutting edges, anti-kickback design and the orange PTFE non-stick coating trademark.

**SAFETY TIPS:** to be used only on router tables equipped with a fence. Do not remove the workpiece while the bit is routing.

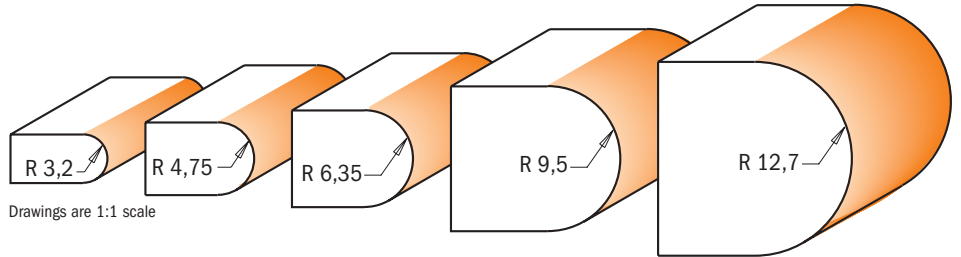
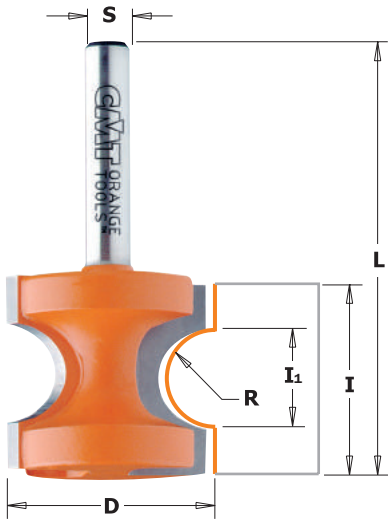

Drawings are 1:1 scale

R mm	D mm	I <sub>1</sub> mm	I mm	L mm		ORDER NO. S=Ø6mm	ORDER NO. S=Ø6,35mm	ORDER NO. S=Ø8mm	ORDER NO. S=Ø12mm	ORDER NO. S=Ø12,7mm
3,2	22,2	6,56	19	50,8	10	<b>754.002.11</b>	<b>854.002.11</b>	<b>954.002.11</b>		
3,2	22,2	6,56	19	57,2	10				<b>954.502.11</b>	<b>854.502.11</b>
4,75	25,4	9,85	22	54	10	<b>754.003.11</b>	<b>854.003.11</b>	<b>954.003.11</b>		
4,75	25,4	9,85	22	60,4	10				<b>954.503.11</b>	<b>854.503.11</b>
6,35	28,6	13,15	25,5	57,2	10	<b>754.004.11</b>	<b>854.004.11</b>	<b>954.004.11</b>		
6,35	28,6	13,15	25,5	63,5	10				<b>954.504.11</b>	<b>854.504.11</b>
9,5	34,9	19,71	35	73	10				<b>954.507.11</b>	<b>854.507.11</b>
12,7	44,5	26,3	41	79,4	10				<b>954.509.11</b>	<b>854.509.11</b>

# Corner Beading Bits



## 7/8/961

Make beautiful traditional beads and edge beads or turn old beads into new moldings with the new CMT corner beading bits with bearing. Featuring carbide-tipped cutting edges and orange PTFE non-stick coating, these bits provide excellent results on corner beads. Run the bead twice to form a complete corner bead.

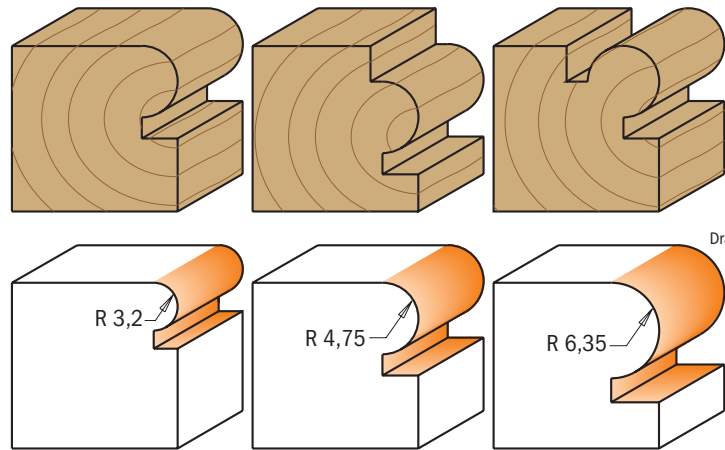
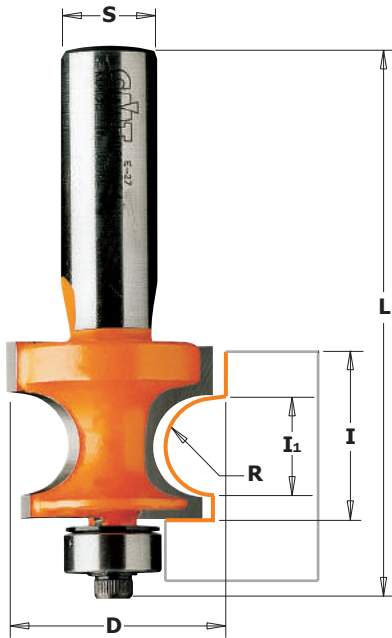

Drawings are 1:1 scale

R mm	D mm	I <sub>1</sub> mm	I mm	L mm		ORDER NO. S=Ø6mm	ORDER NO. S=Ø6,35mm	ORDER NO. S=Ø8mm	ORDER NO. S=Ø12mm	ORDER NO. S=Ø12,7mm	Spare parts		
3,2	22,2	6,50	15	57,7	10	<b>761.032.11</b>	<b>861.032.11</b>	<b>961.032.11</b>					
3,2	22,2	6,50	15	64	10				<b>961.532.11</b>	<b>861.532.11</b>	990.423.00	791.003.00	990.058.00
4,75	25,4	9,68	18,6	61,2	10	<b>761.048.11</b>	<b>861.048.11</b>	<b>961.048.11</b>			990.423.00	791.003.00	990.058.00
4,75	25,4	9,68	18,6	67,6	10				<b>961.548.11</b>	<b>861.548.11</b>	990.423.00	791.003.00	990.058.00
6,35	28,6	12,86	22,2	64,8	10	<b>761.064.11</b>	<b>861.064.11</b>	<b>961.064.11</b>			990.423.00	791.003.00	990.058.00
6,35	28,6	12,86	22,2	71,7	10				<b>961.564.11</b>	<b>861.564.11</b>	990.423.00	791.003.00	990.058.00

Spare parts 991.057.00 3/32" hex key

# Edge-Fluting Bits

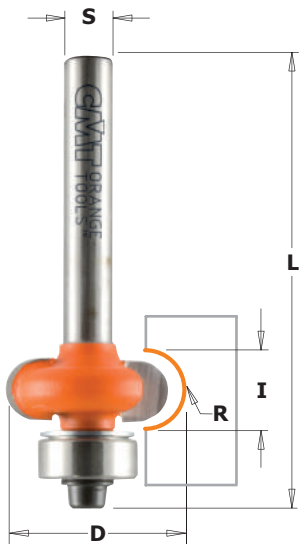

## 7/862

The edge-fluting bearing guided bits are quick to set up and can be used for curved screens, small radius grooves, doors etc. No side fence is required. Use in a handheld or table-mounted router.

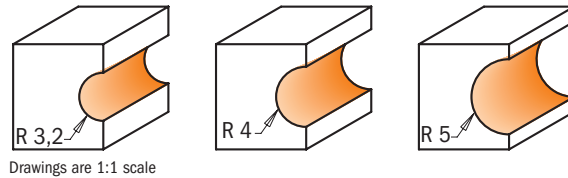

Drawings are 1:1 scale



For top bearing version: use bearing **791.010.00** and stop collar **541.001.00** (optional)

R mm	D mm	I mm	L mm		ORDER NO. S=Ø6mm	ORDER NO. S=Ø6,35mm
3,2	19,05	6,4	57	10	<b>762.032.11</b>	<b>862.032.11</b>
4	20,7	8	57	10	<b>762.040.11</b>	<b>862.040.11</b>
5	22,7	10	57	10	<b>762.050.11</b>	<b>862.050.11</b>

Spare parts			
990.423.00	791.003.00	990.058.00	991.057.00
990.423.00	791.003.00	990.058.00	991.057.00
990.423.00	791.003.00	990.058.00	991.057.00

# CMT Moulding System

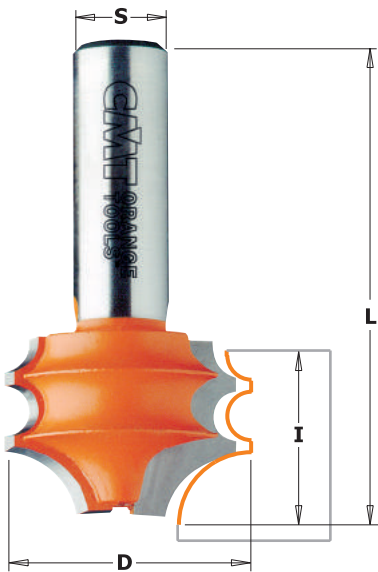

## 8/956.852

If the standard selection of moulding and mill work you find in today's lumber shops isn't satisfactory to your woodworking tastes, then look to CMT's moulding system instead. With these bits, you can make dozens of elaborate profiles by combining two or more passes. Avoid the average and create your own mouldings. Some initial suggestions are illustrated below.

**SAFETY TIPS:** use these bits with a fence. The profiles shown below are milled from heavy stock then refined to the desired shape.

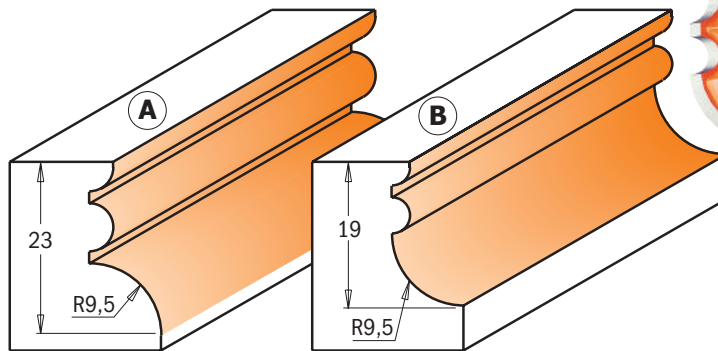

Drawings are 1:1 scale



## 8/956.851

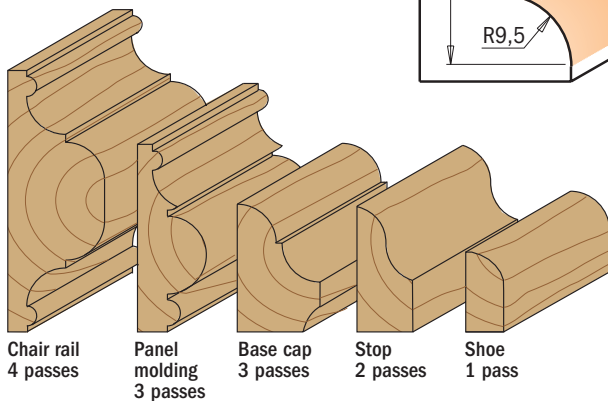

PROFILE	D mm	I mm	L mm		ORDER NO. S=Ø12mm	ORDER NO. S=Ø12,7mm
A	31,7	23	61,1	10	<b>956.852.11</b>	<b>856.852.11</b>
B	31,7	19	57,2	10	<b>956.851.11</b>	<b>856.851.11</b>

## 8/956.8



Create endless profiles with CMT multiprofile bits. Simply adjust the height of the bit to create classic profiles in one single pass, or make more complex decorative effects in multiple passes. The bits super-strength steel body can withstand long-lasting cutting operations, and the micrograin carbide tips remain sharp longer for superior performance. In addition these bits feature non-stick PTFE coating and anti-kickback design. To be used on tables equipped with a fence.

**SAFETY TIPS:** to make small mouldings as shown below, cut the profile from very wide stock. Remove the excess material and work on the bigger piece to give you easier control. Keep hands far from the bit when working.

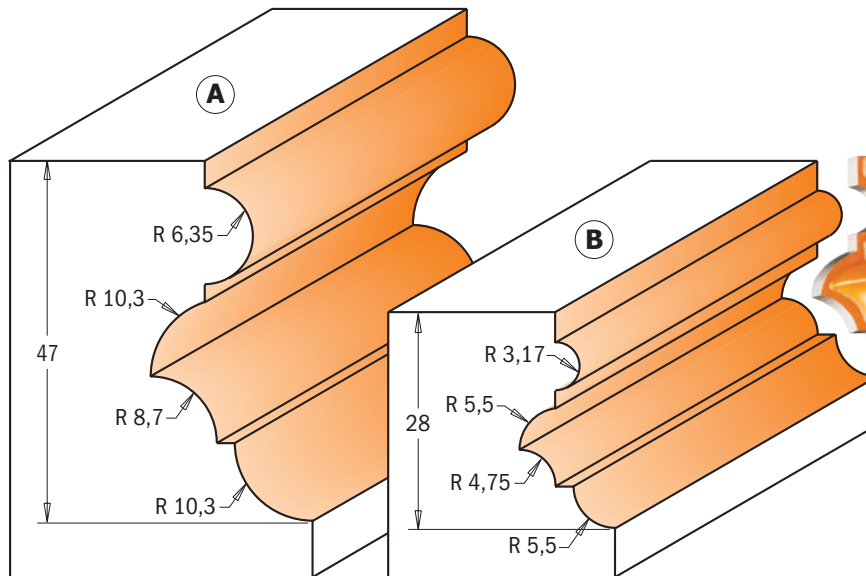
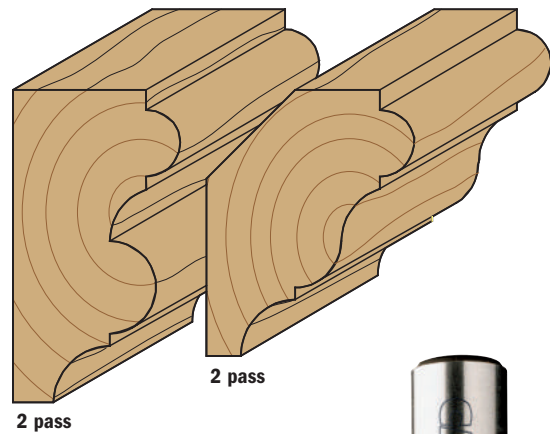
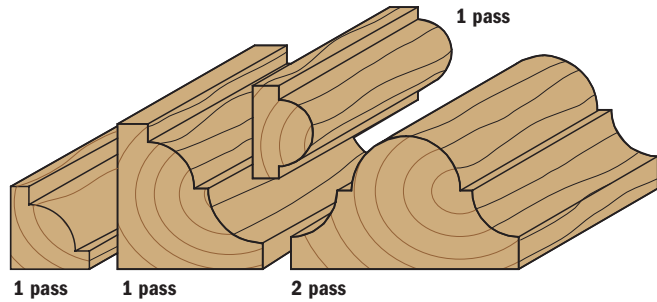
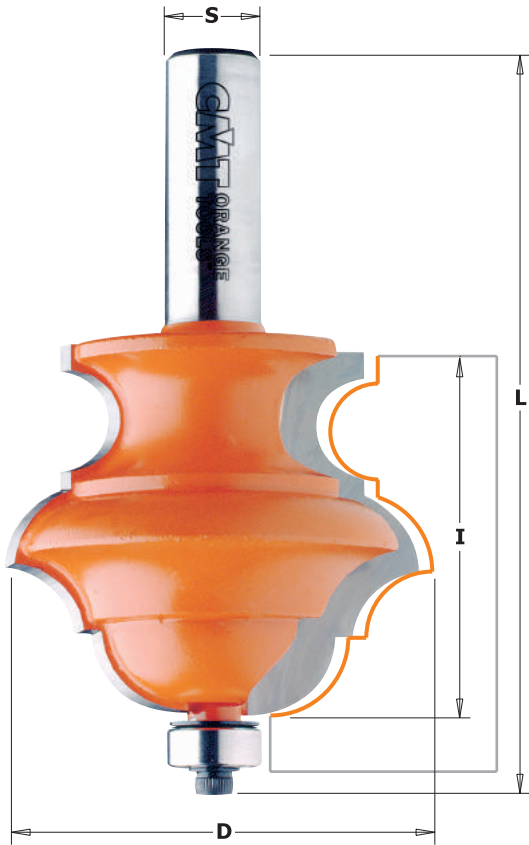

Drawings are 1:1 scale



PROFILE	D mm	I mm	L mm		ORDER NO. S=Ø12mm	ORDER NO. S=Ø12,7mm	Spare parts			
A	55,6	47	96,4	5	<b>956.802.11</b>	<b>856.802.11</b>				
B	38,1	28	77,5	10	<b>956.801.11</b>	<b>856.801.11</b>	990.423.00	791.003.00	990.058.00	991.057.00



# Moulding Bits

Why waste time searching for a particular style of frame moulding when you can just as quickly and easily make your own. With the wide range of decorative possibilities offered by CMT moulding bits, you can always create the edge profile you want, anywhere you want and any time you want. These bits are made to last a lifetime! Carbide-tipped cutters and solid bar stock steel shanks can withstand rigorous use and the non-stick PTFE coating allows for clean, smooth-running cuts. The anti-kickback design guarantees safer operation when using these wide profile bits.



**SHOP TIPS:** multiple pass operations require advance planning. To avoid making a mistake that could render it impossible to finish the job, carefully consider the entire cutting sequence before you begin.

**SAFETY TIPS:** all large diameter bits such as these should be used with caution and on router tables equipped with a fence. For best results, 1,7 KW (2-1/4 HP) routers are recommended. Routers as low-powered as 1,1 KW (1-1/2 HP) can be used if limited to shorter, shallower runs. When possible, reduce the RPMs of the router for operations requiring the use of these bits.

Drawings are 1:1 scale

**8/956.501**

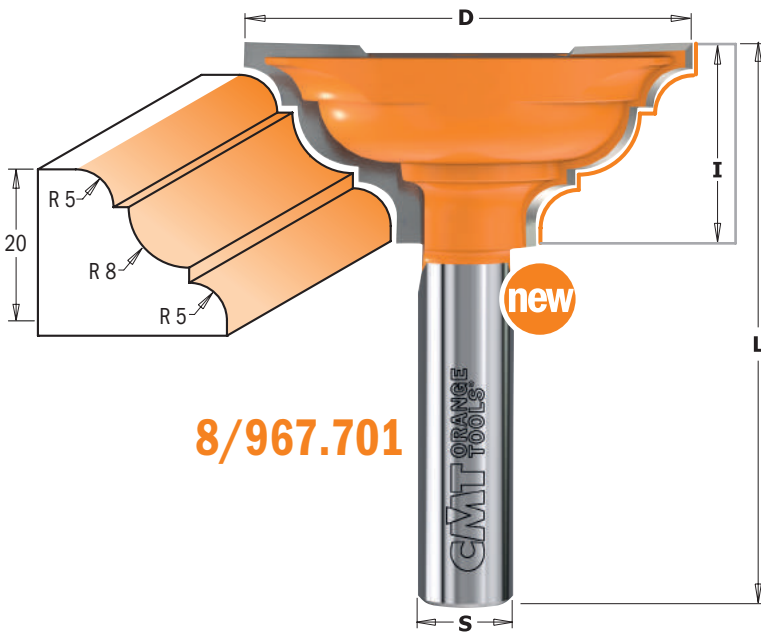
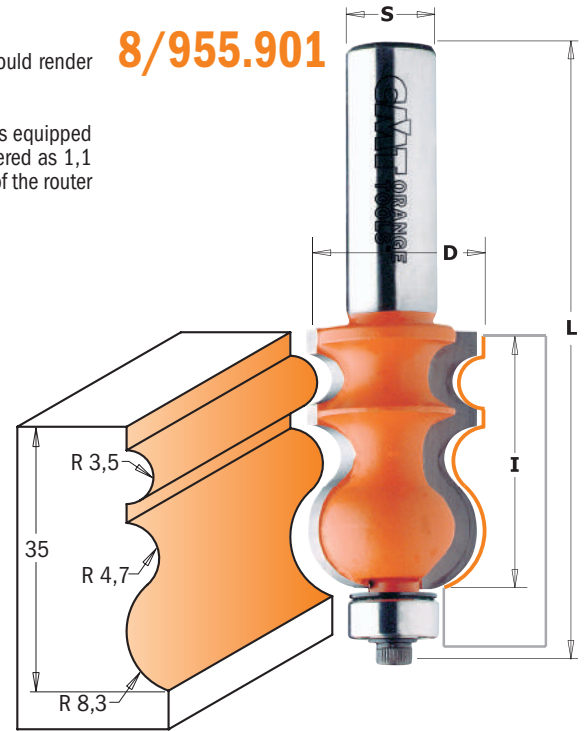
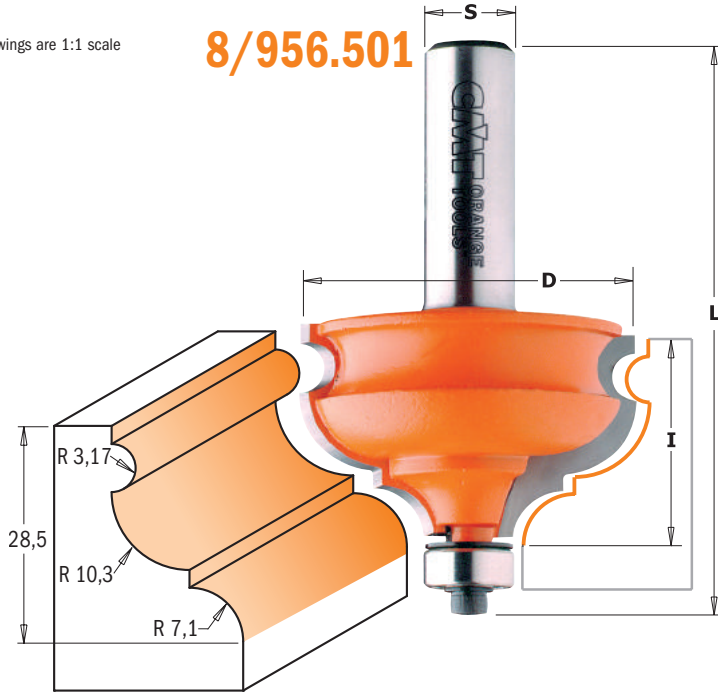

**8/955.902**

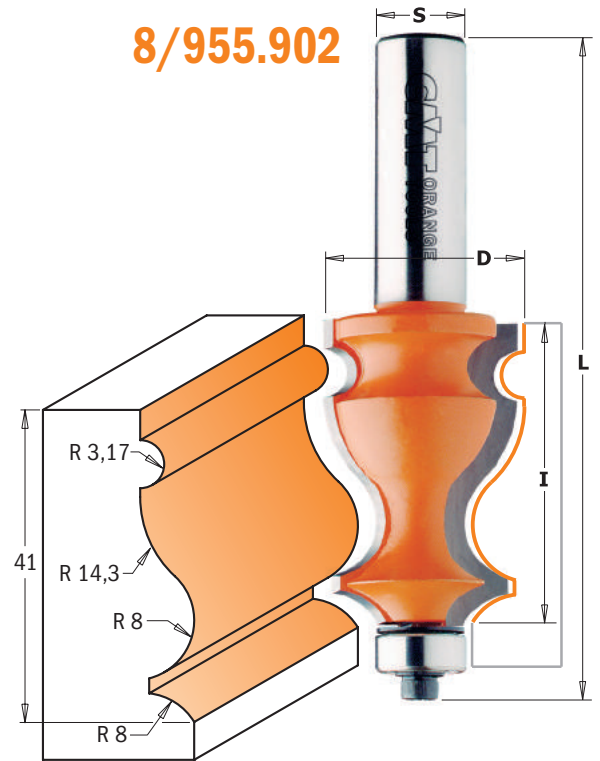

D mm	I mm	L mm		ORDER NO. S=Ø12mm	ORDER NO. S=Ø12,7mm	Spare parts				
23,8	35	83,8	10	<b>955.901.11</b>	<b>855.901.11</b>					990.423.00 791.003.00 990.058.00 991.057.00
27	41	90,2	10	<b>955.902.11</b>	<b>855.902.11</b>					990.423.00 791.003.00 990.058.00 991.057.00
47,5	28,5	77,4	10	<b>956.501.11</b>	<b>856.501.11</b>					990.423.00 791.003.00 990.058.00 991.057.00
<b>new</b> 58	25,4	73,5	10	<b>967.701.11</b>	<b>867.701.11</b>					

**SHOP TIPS:** oversized bearing to use after resharpening.  
**791.063.00** Ø12,5 replace bearing 791.003.00 (Ø12,7) after resharpening

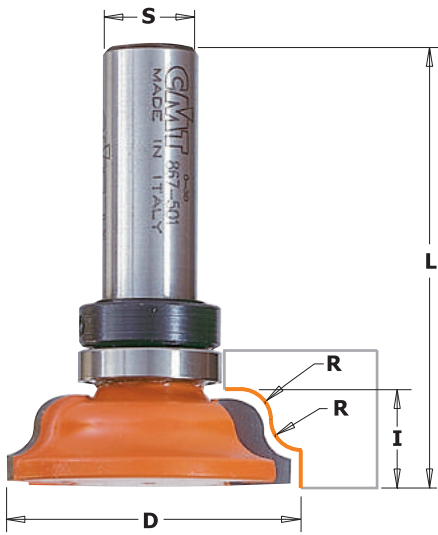

## 8/967.5B - 8/967.6B

CMT's new moulding bits allow you to shape elegant moldings with your table saw and router. Unlike any commercially available crown moldings, moldings made with these bits are easy to install and create a finished appearance. After shaping the cove, you can use special router bits with inverted profiles to create different edges and complete the moulding.

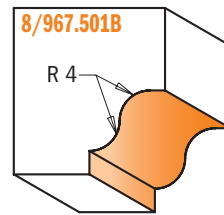
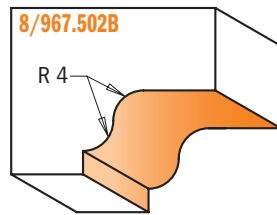
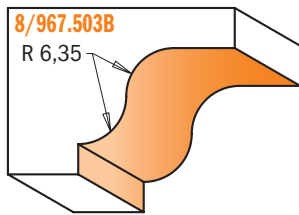
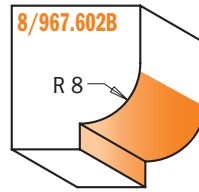
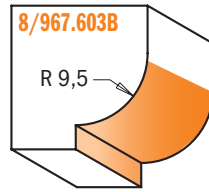

Drawings are 1:1 scale

R mm	D mm	I mm	L mm		ORDER NO. S=Ø8mm	ORDER NO. S=Ø12mm	ORDER NO. S=Ø12,7mm	Spare parts							
4	39,05	11,5	57	10	<b>967.001.11B</b>	<b>967.501.11B</b>	<b>867.501.11B</b>					791.011.00	541.002.00	990.005.00	991.056.00
4	54	11,5	65,9	10		<b>967.502.11B</b>	<b>867.502.11B</b>					791.011.00	541.002.00	990.005.00	991.056.00
6,35	60,5	17,3	71,7	5		<b>967.503.11B</b>	<b>867.503.11B</b>					791.011.00	541.002.00	990.005.00	991.056.00
6,35	38	12,5	57	10	<b>967.101.11B</b>	<b>967.601.11B</b>	<b>867.601.11B</b>					791.011.00	541.002.00	990.005.00	991.056.00
8	35	13,2	57,7	10	<b>967.102.11B</b>	<b>967.602.11B</b>	<b>867.602.11B</b>					791.011.00	541.002.00	990.005.00	991.056.00
9,5	38	14,5	59	10	<b>967.103.11B</b>	<b>967.603.11B</b>	<b>867.603.11B</b>					791.011.00	541.002.00	990.005.00	991.056.00

## Finger pull door lip bit

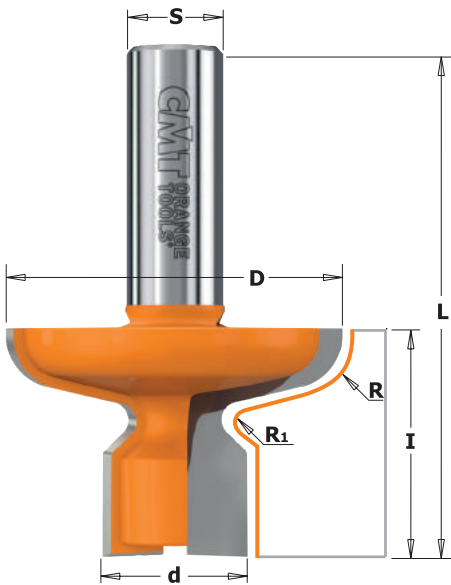

## 8/955.604-606

Why interrupt the subtle linearity of an all-wood drawer front or cabinet door with a metal knob or handle? Two options are available: a template profile made directly in the wood or a European-style hardwood pull as illustrated below.

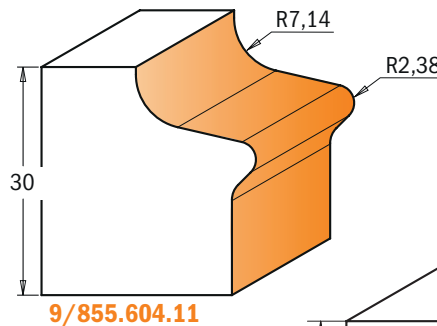

8/955.604.11

Drawings are 1:1 scale

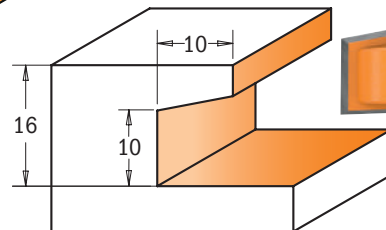

8/955.606.11



D mm	d mm	I mm	R mm	R1 mm	L mm		ORDER NO. S=Ø12mm	ORDER NO. S=Ø12,7mm
36	16	16			60	10		<b>855.606.11</b>
47,6	22,2	30	7,14	2,38	66,6	10	<b>955.604.11</b>	<b>855.604.11</b>

# Finger Pull Bit

## 8/955



Why interrupt the subtle linearity of an all-wood drawer front or cabinet door with a metal knob or handle? Use a CMT finger pull bit and make a harmonious wooden handle. Two options are available: a template profile made directly in the wood or a European-style hardwood pull as illustrated below.

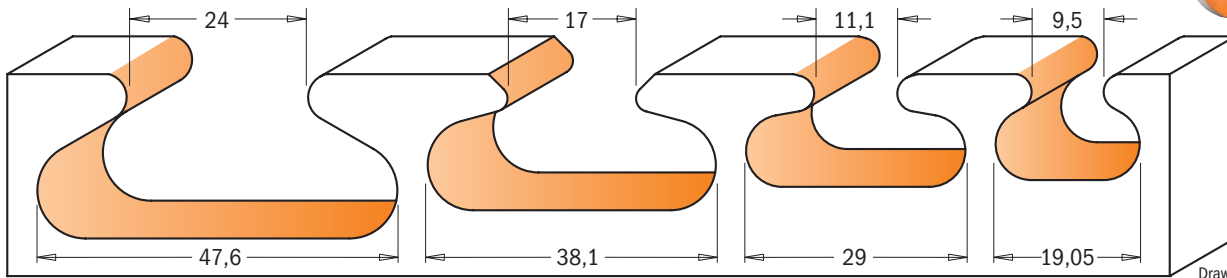
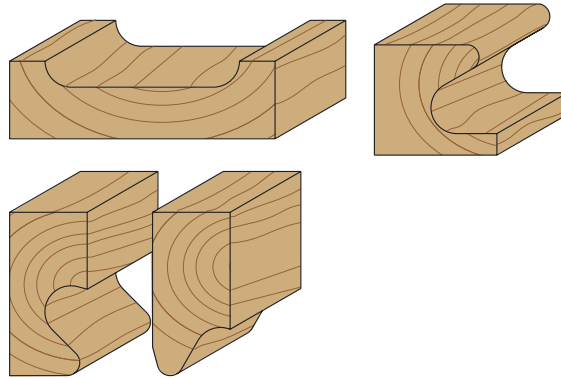
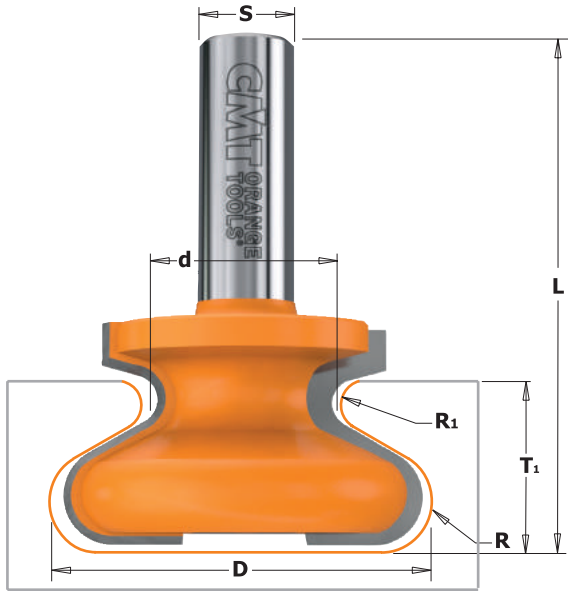

Drawings are 1:1 scale

D mm	d mm	T <sub>1</sub> mm	I mm	R mm	R <sub>1</sub> mm	L mm		ORDER NO. S=Ø8mm	ORDER NO. S=Ø12mm	ORDER NO. S=Ø12,7mm
19,05	9,5	14	19,05	4,76	2,4	57,2	10	<b>955.102.11</b>		<b>855.602.11</b>
29	11,1	15	20	4,8	2,3	60	10			<b>855.605.11</b>
38,1	17	18	20,7	6	1,8	55,5	10	<b>955.103.11</b>		
38,1	17	18	20,7	6	1,8	61,8	10			<b>855.603.11</b>
47,6	24	22	28,5	6,35	3,2	66,6	10		<b>955.601.11</b>	<b>855.601.11</b>

## Window Sill & Finger Bits

### 8/955.8 - 8/955.8B



Originally, these profiles were designed for shaping the edges of window sills. Yet, these bits also can be used to create finger pulls on the edges of doors and drawers. These bits are available with top bearings for curved template work or without bearings for straight cuts against a fence. Recommended for router table use only.

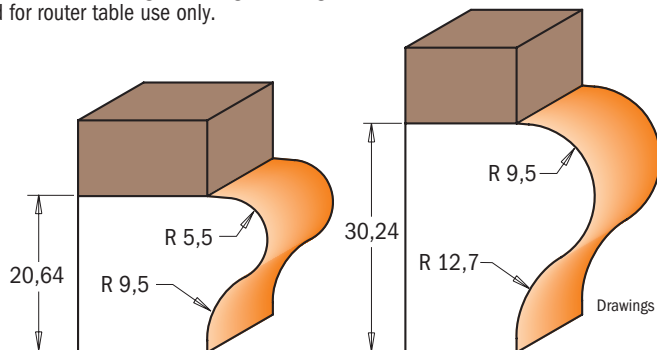
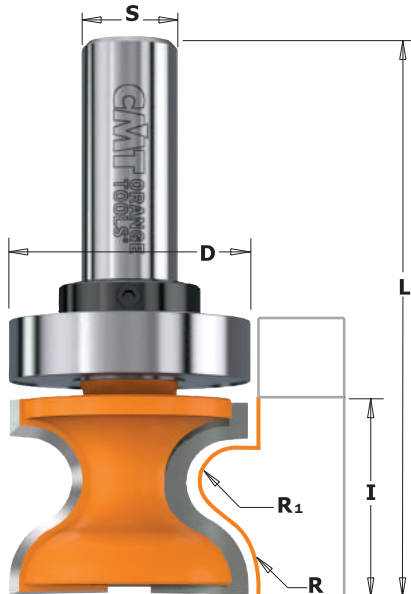

Drawings are 1:1 scale

R <sub>1</sub> mm	R mm	D mm	I mm	L mm		ORDER NO. S=Ø12mm	ORDER NO. S=Ø12,7mm
5,5	9,5	31,7	25,4	73	10	<b>955.804.11</b>	<b>855.804.11</b>
9,5	12,7	38,1	35	85,8	10	<b>955.805.11</b>	<b>855.805.11</b>
<b>With Top Bearing</b>							
5,5	9,5	31,7	25,4	73	10	<b>955.804.11B</b>	
5,5	9,5	31,7	25,4	73	10		<b>855.804.11B</b>
9,5	12,7	38,1	35	85,8	10	<b>955.805.11B</b>	
9,5	12,7	38,1	35	85,8	10		<b>855.805.11B</b>

Spare parts			
791.015.00	541.005.00	990.005.00	991.056.00
791.015.00	541.002.00	990.005.00	991.056.00
791.020.00	541.005.00	990.005.00	991.056.00
791.020.00	541.002.00	990.005.00	991.056.00



# Table Edge & Hand Rail Bits

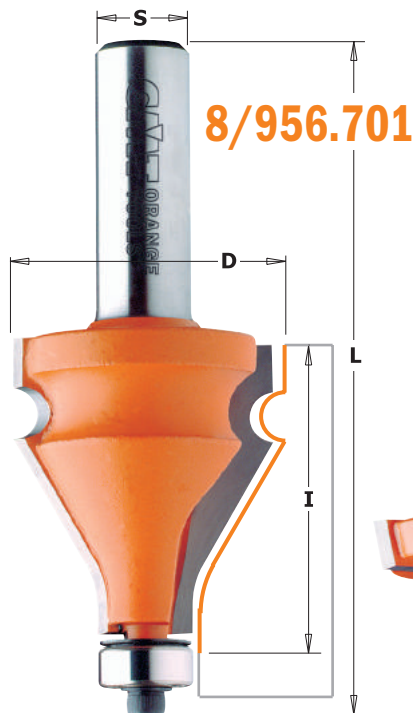

8/956.701

Turn a small investment into big returns with these CMT bits! These bits guarantee well-proportioned smooth curves, adding a touch of class and creating elegant eye-catching work. CMT hand rail bits feature a 30° bevel edge and a 3.2mm bead that craft beautiful and functional hand rails.

**SAFETY TIPS:** these profile bits remove large amounts of stock and make consistent quantities of dust. We recommend using a vacuum to keep the work area safe.

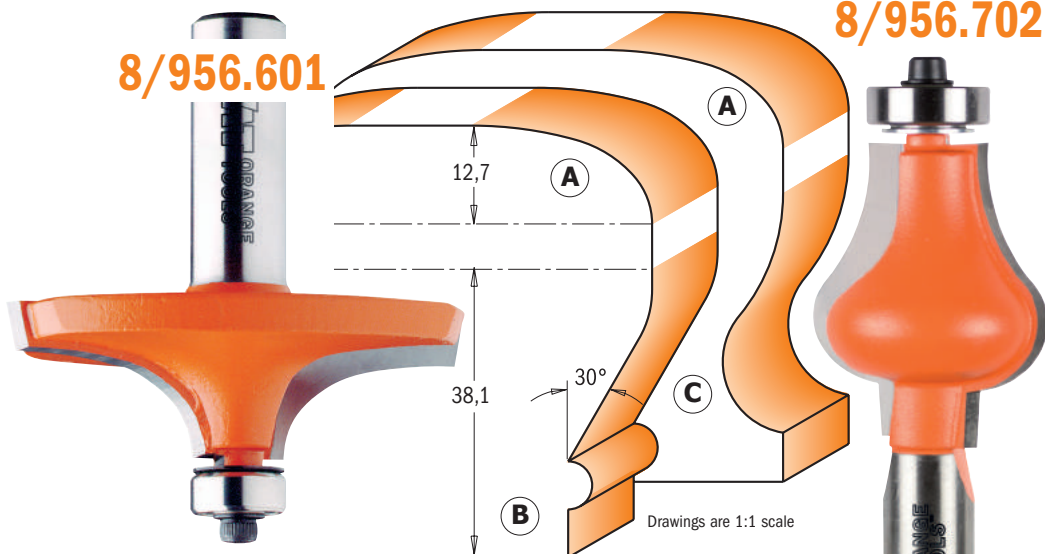

8/956.601

8/956.702

Drawings are 1:1 scale

PROFILE	D mm	I mm	L mm		ORDER NO. S=Ø12mm	ORDER NO. S=Ø12,7mm	Spare parts							
A	63,5	19	67,9	5	956.601.11	856.601.11					990.423.00	791.003.00	990.058.00	991.057.00
B	35	38	87	10	956.701.11	856.701.11					990.423.00	791.003.00	990.058.00	991.057.00
C	31,7	38,1	87	10	956.702.11	856.702.11					990.423.00	791.018.00	990.058.00	991.057.00

**SHOP TIPS:** undersized bearing to use after resharpening.  
791.063.00 Ø12,5 replace bearing 791.003.00 (Ø12,7) after resharpening

# Vertical Raised Panel Bits

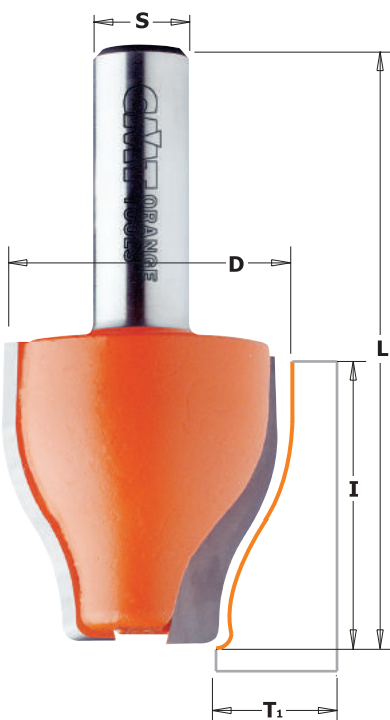

8/990.6



Create raised panel doors and drawer fronts easily and economically by simply putting a CMT vertical raised panel bit in your router\* and a sturdy 90° angle fence on your router table. Studied, designed and crafted with the most sophisticated technology available, these bits are perfected down to the smallest detail. Choose from three vertical profile designs.

\* Recommended for use on routers with a minimum speed of 1,7 KW (2-1/4 HP). Routers as low-powered as 1,1 KW (1-1/2 HP) can be used but we suggest limiting their use to shorter, shallower runs.

**SAFETY TIPS:** the template must be at least 150mm and clamps should be used whenever possible. Three to five passes are recommended to safely and accurately obtain the profile you desire.

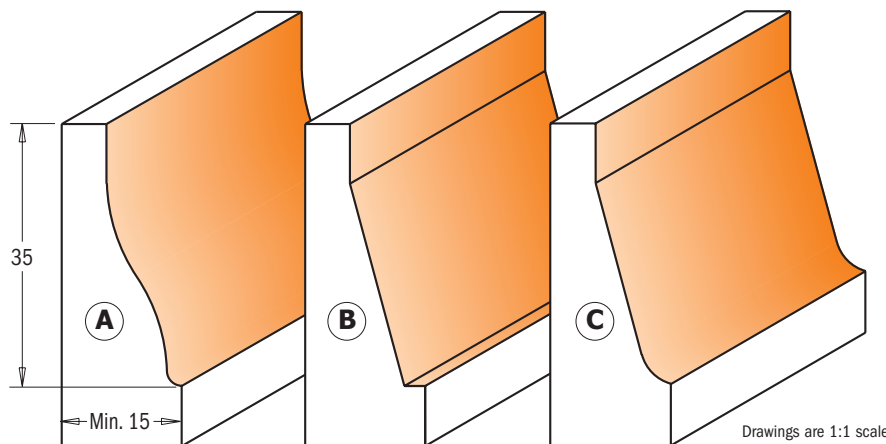

Drawings are 1:1 scale

PROFILE	D mm	I mm	T <sub>1</sub> mm	L mm		ORDER NO. S=Ø12mm	ORDER NO. S=Ø12,7mm
A	38	38	15 ÷ 18	76,2	10	990.601.11	890.601.11
B	38	38	15 ÷ 18	76,2	10	990.602.11	890.602.11
C	38	38	15 ÷ 18	76,2	10	990.603.11	890.603.11

# Junior Ogee Rail & Stile Set

**8/991.517**



These bits are designed for those special projects that require a smaller panel door. Use these bits with stock from 11,1mm to 17,4mm thick, and build doors as small as 70mm.

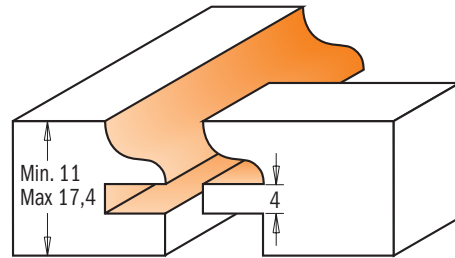
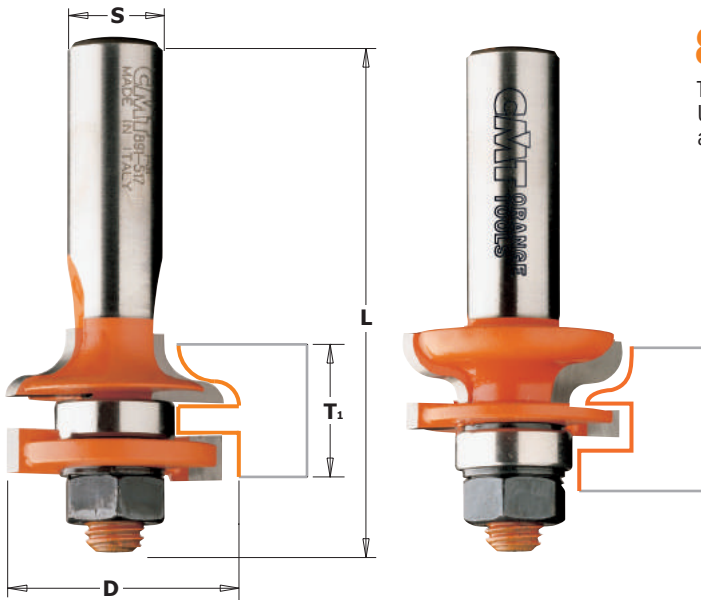

Drawings is 1:1 scale

D mm	T <sub>1</sub> mm	L mm		ORDER NO. S=Ø12mm	ORDER NO. S=Ø12,7mm	Spare parts							
31,75	11 ÷ 17,4	67	5	<b>991.517.11</b>	<b>891.517.11</b>					822.008.11	822.009.11	791.025.00	990.020.00

**Spare parts**  
 541.515.00 0,1mm spacer  
 541.516.00 0,3mm spacer  
 541.518.00 1,0mm spacer

# Rail & Stile Set

**8/991**



Designed for fine furniture construction, these bits mill a delicate 4,75mm thumb-nail profile in stock from 15,8mm to 20,6mm.

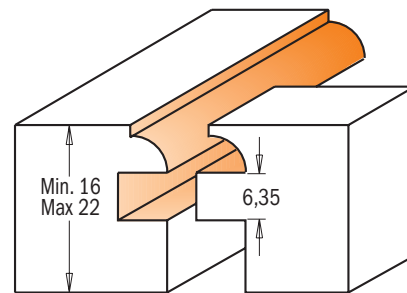
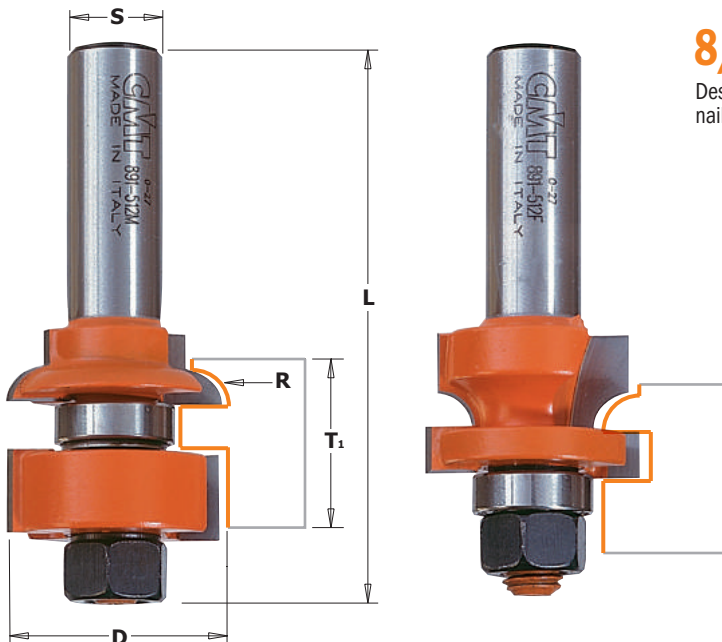

Drawings is 1:1 scale

D mm	T <sub>1</sub> mm	R mm	L mm		ORDER NO. S=Ø8mm	ORDER NO. S=Ø12,7mm	Spare parts							
28,7	16 ÷ 22	4,8	79,2	10	<b>991.012.11</b>	<b>891.512.11</b>					822.011.11	822.012.11	791.025.00	990.020.00

**Spare parts**  
 541.515.00 0,1mm spacer  
 541.516.00 0,3mm spacer  
 541.518.00 1,0mm spacer

In our step-by-step example of panel door construction, we used the following:

- CMT Rail & Stile set (item #891.502.11)
- CMT Reverse Glue Joint (item #855.501.11)
- pre-cut to length stiles - 19mm thick x 57mm wide
- pre-cut to length rails - 19mm thick x 57mm wide
- panel - 16mm thick
- scrap stock

The CMT Rail & Stile set was designed ideally for the construction of panel doors from 19mm thick stock, however any variation of size up to 22mm thick can be used. Remember to adjust your measurements and cutting depths according to the wood thickness you use.

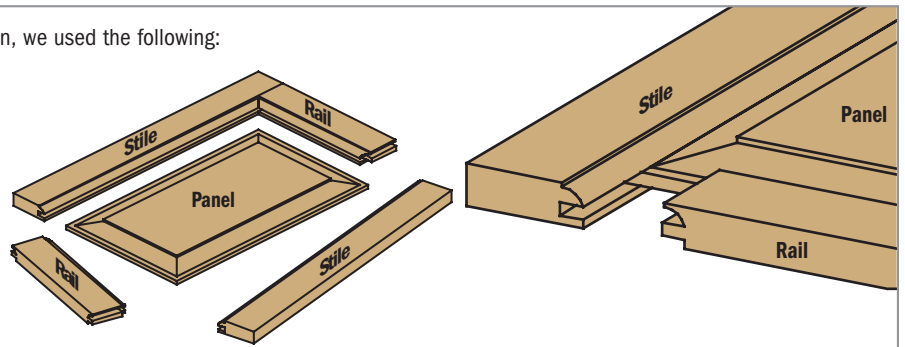

ILLUSTRATION A

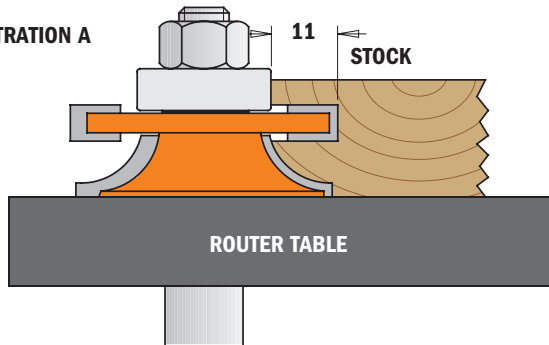
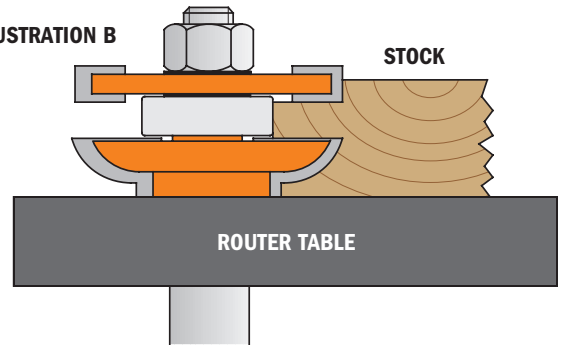

ILLUSTRATION B



### MILLING THE RAILS AND STILES

First make trial cuts of the cope profile (rail) and the stick profile (stile) in scrap stock and check the accuracy of the joint. This is extremely important when working at maximum thickness (22mm). Make sure your stock is flat and cut straight with square edges. Using the CMT Stile Bit shown in illustration A, place the stock front face-down on the router table and mill the stick profile in the stile and rail pieces. To mill the rails, use the CMT Rail Bit shown in illustration A, position the rails face-down on the router table and mill the cope profile on the ends. If you are milling cope and stick profiles before cutting the rails and stiles to length, be sure to make the proper calculations before cutting the rails. The stiles are the same length as the door. The rails must be calculated by the following equation (CMT standard tenon length is 22mm):

(total door width - sum of stile widths) + sum of 2 tenons = total rail length  
 therefore, using our example measurements listed above, for a 300mm cabinet door:  
 $300\text{mm} - 114\text{mm} + 22\text{mm} = 208\text{mm}$

### GLUEING UP PANELS

If the panel requires a width greater than the width of your stock, you will need to edge glue stock for the central floating panel. This is accomplished by simply using the CMT Reverse Glue Joint bit. For making a two panel glue joint, place the first panel front face-down on the router table and accurately centre the wood to the bit. Adjust the bit according to the thickness of the wood you are cutting by lining up the cut edge of the wood to the centre point of the bit as illustrated in illustration B and mill the cut edge of the wood. Place the second panel front face up and repeat the milling process. This assures you will have the best side of your stock as a front face. If a third panel is required, mill one cut edge of the piece as instructed above, turn the piece over and run the other edge. Assemble the reverse cut pairs together for beautiful, strong joints that match up perfectly.

ILLUSTRATION C

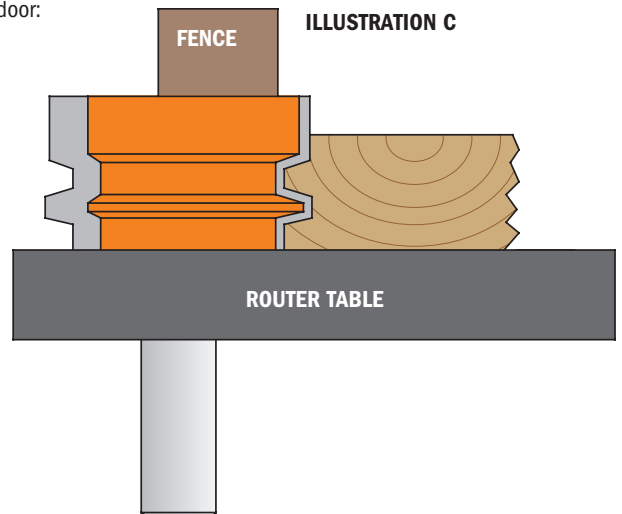

### MILLING THE FLOATING PANEL

Make trial cuts in scrap stock to create a tongue that fits snugly into the groove in the stile without forcing it. To cut your panel to size be sure to make the proper calculations, taking into account the length of the tongue. The CMT Raised Panel Bit in our example has a standard tongue length of 8mm (The New CMT Raised Panel Bit profile has a 9,5mm tongue).

Use the following equation:  
 (Total door length - Sum of Stile widths) + Sum of 2 Tongues = Overall Panel Length

Therefore, using our example, measurements listed above for a 600mm long cabinet door:  $(600 - 114) + 16\text{mm} = 502\text{mm}$

And accordingly:  
 (Total door width - Sum of Stile widths) + Sum of 2 Tongues = Overall Panel Width.

Once the panel has been cut to proper dimensions, position the panel front face side down on the router table tongue as shown in illustration C and use the CMT Raised Panel Bit to mill the tongue. ATTENTION: this bit is capable of removing large amounts of stock. To safely and effectively produce the profile you want, we suggest making several shallow passes. It can be dangerous to try to mill the entire profile in a single run.

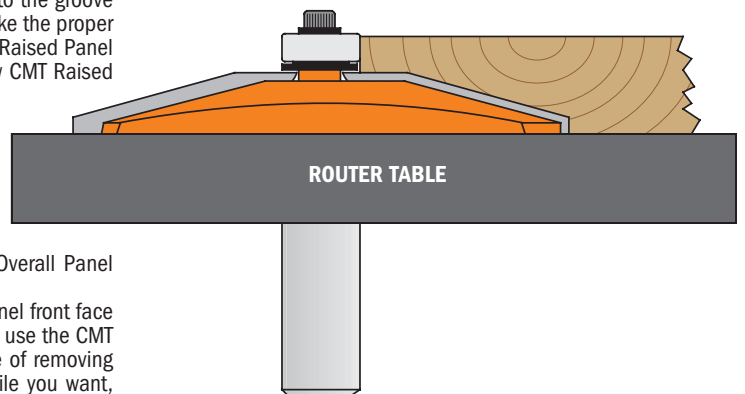



# Rail & Stile Sets

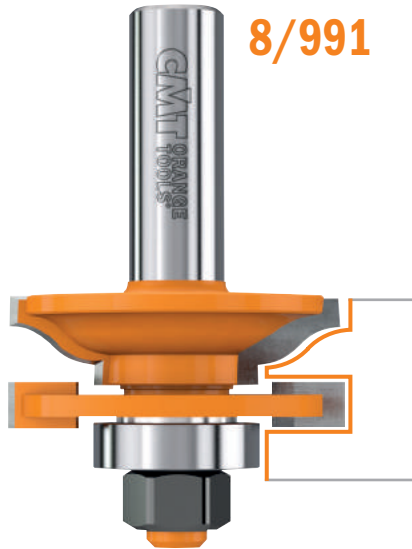
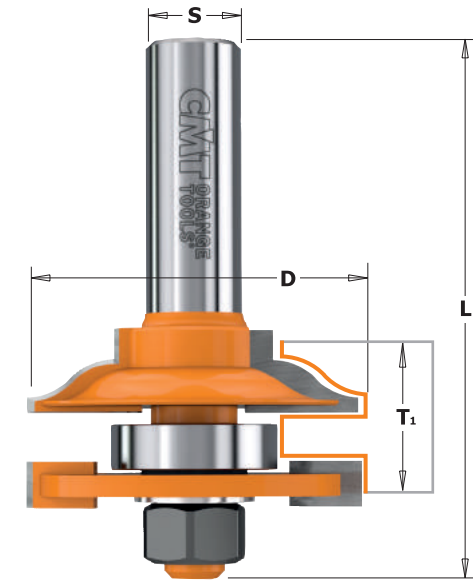

8/991



A well constructed door will bear the mark of a perfect joint: clean, precise and well-crafted for strength. The CMT male-female rail and stile sets are a perfect pair for this particular project.

Made to our specifications, they match perfectly unlike the approximative results offered by standard reversible cutters.

Choose the style of CMT rail and stile set that best suits your needs and create smooth, perfect joints in hard and soft woods with accuracy and speed. Perfect for working in stock from 18mm to 22mm. See chart and illustrations below for profile options available.

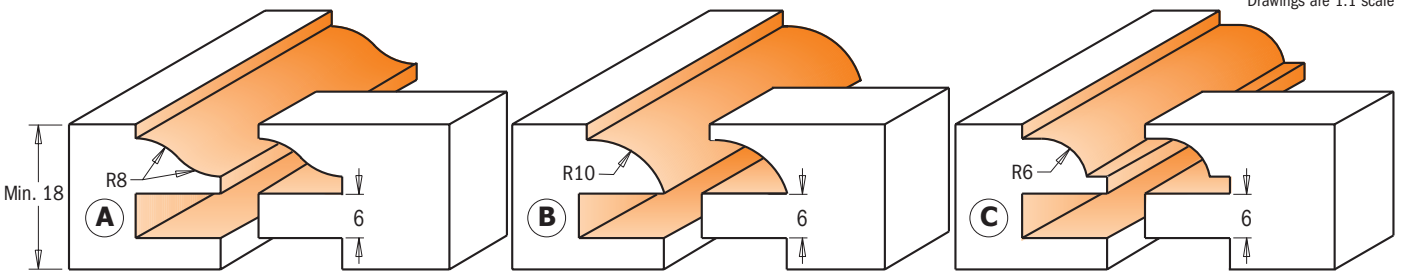

Drawings are 1:1 scale

PROFILE	D mm	L mm	T <sub>1</sub> mm		ORDER NO. S=Ø8mm	ORDER NO. S=Ø12mm	ORDER NO. S=Ø12,7mm	Spare parts											
A	44,4	71	18 ÷ 22	5	<b>991.001.11</b>	<b>991.501.11</b>	<b>891.501.11</b>							822.003.11	791.012.00	541.515.00	514.516.00	990.407.00	990.020.00
B	44,4	71	18 ÷ 22	5		<b>991.502.11</b>	<b>891.502.11</b>	822.003.11	791.012.00	541.515.00	514.516.00	990.407.00	990.020.00	822.003.11	791.012.00	541.515.00	514.516.00	990.407.00	990.020.00
C	44,4	71	18 ÷ 22	5		<b>991.503.11</b>	<b>891.503.11</b>	822.003.11	791.012.00	541.515.00	514.516.00	990.407.00	990.020.00	822.003.11	791.012.00	541.515.00	514.516.00	990.407.00	990.020.00

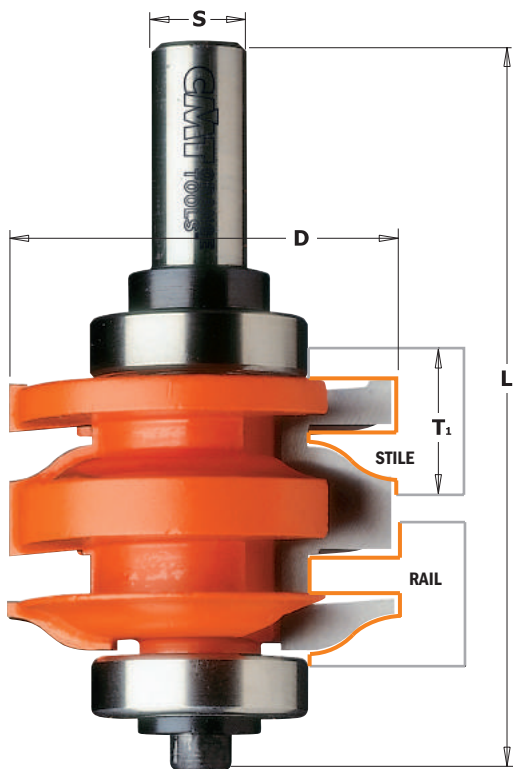

8/991.521



The most innovative bit for the construction of furniture doors and drawers. The new CMT One-Piece Rail and Stile Bit represents the union of two cutters in one bit. By simply adjusting the height of the bit, you can cut two perfectly joining profiles with no wasted time or effort moving the fence or changing the bit. Save time and money by investing in one single CMT bit. Suitable for stock ranging from 18mm to 22.2mm in thickness.

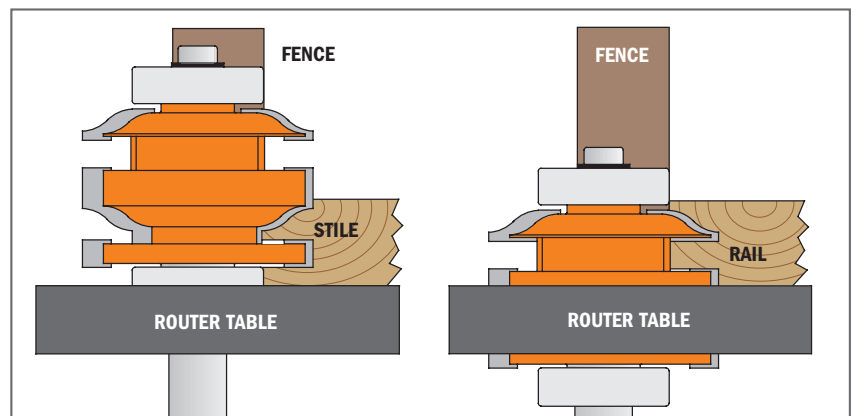

PROFILE	D mm	L mm	T <sub>1</sub> mm		ORDER NO. S=Ø12mm	ORDER NO. S=Ø12,7mm	Spare parts													
A	50,87	96	18 ÷ 22	10		<b>891.521.11</b>								791.027.00	541.002.00	990.005.00	991.056.00	541.551.00	990.010.00	991.064.00
A	50,87	96	18 ÷ 22	10	<b>991.521.11</b>		791.027.00	541.005.00	990.005.00	991.056.00	541.551.00	990.010.00	991.064.00	791.027.00	541.005.00	990.005.00	991.056.00	541.551.00	990.010.00	991.064.00



## 8/990

We offer you the traditional approach to panel construction with the CMT raised panel bit. Make classic raised panel doors as shown in the profiles below.

These raised panel bits have carbide-faced cutting edges and are equipped with our anti-kickback design and orange non-stick coating to further improve safety when working with larger diameter bits.

**SAFETY TIPS:** Horizontally employed bits should be used at a lower speed, between 10,000 and 12,000 RPMs.

Three to five passes are recommended to safely and accurately obtain the profile you desire.

To be used on jigs with at least 1,7 KW (2-1/4 HP).

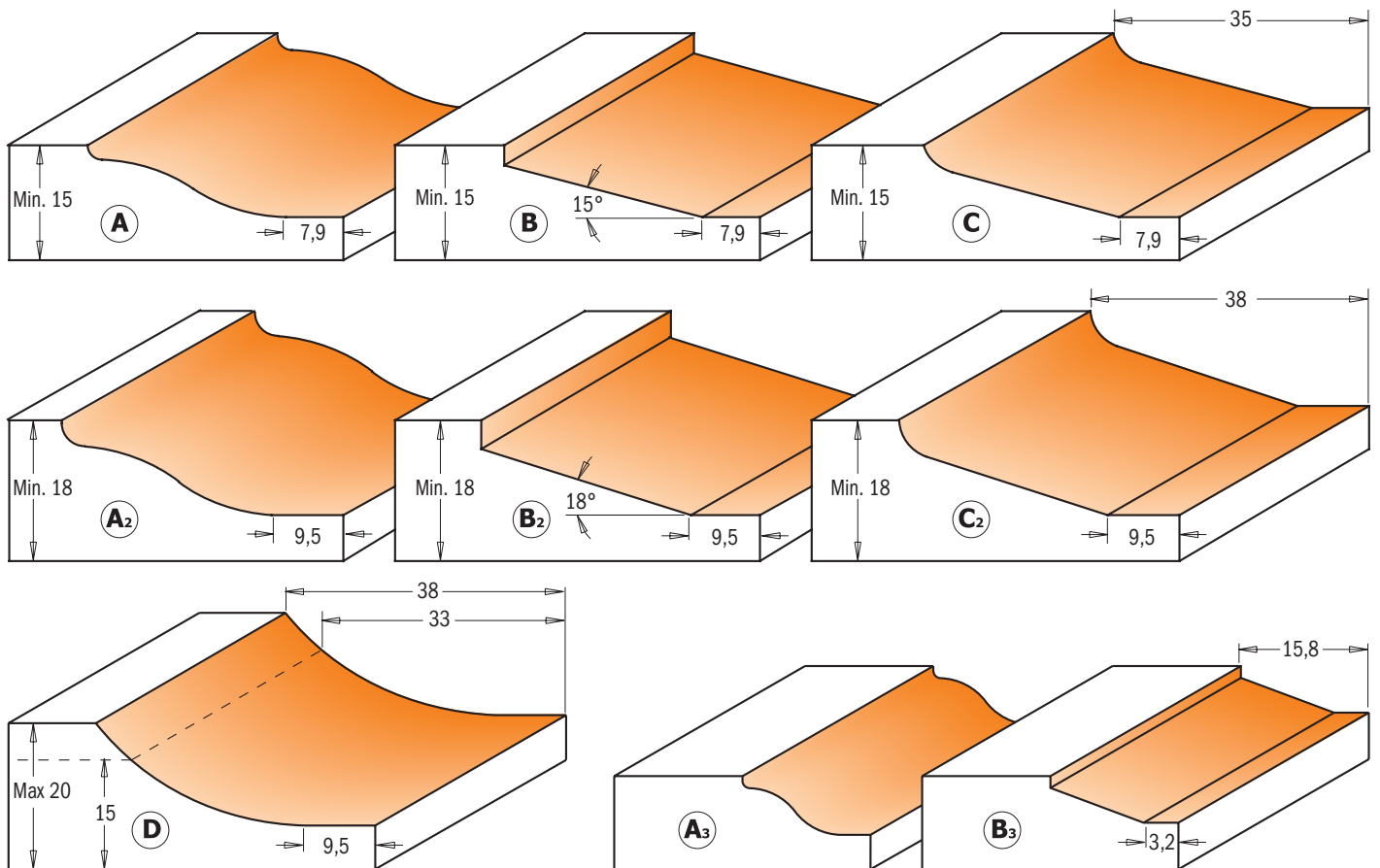
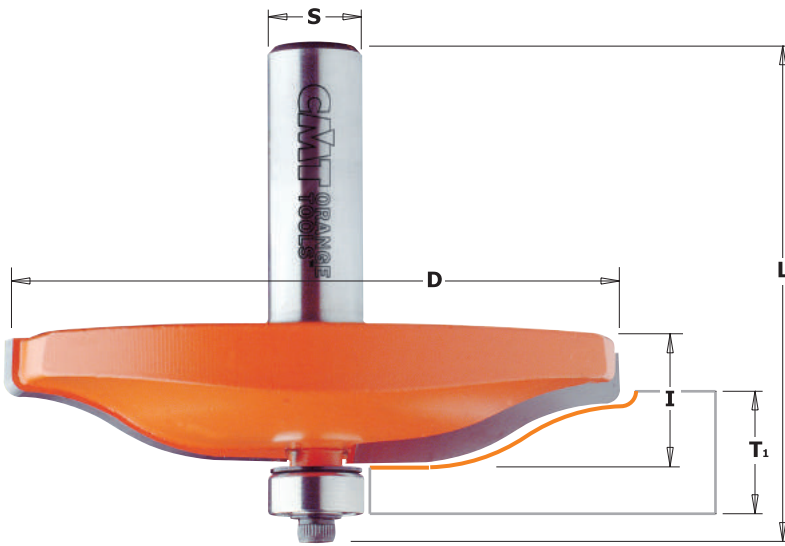

Drawings are 1:1 scale

PROFILE	D mm	I mm	L mm	T <sub>1</sub> mm		ORDER NO. S=∅8mm	ORDER NO. S=∅12mm	ORDER NO. S=∅12,7mm	Spare parts			
A	82,5	15	63,8	15 ÷ 18	5		<b>990.501.11</b>	<b>890.501.11</b>				
B	82,5	15	63,8	15 ÷ 18	5		<b>990.502.11</b>	<b>890.502.11</b>	990.423.00	791.003.00	990.058.00	991.057.00
C	82,5	15	64,6	15 ÷ 18	5		<b>990.503.11</b>	<b>890.503.11</b>	990.423.00	791.003.00	990.058.00	991.057.00
A <sub>2</sub>	89	15	64,6	18 ÷ 20	5		<b>990.504.11</b>	<b>890.504.11</b>	990.423.00	791.003.00	990.058.00	991.057.00
B <sub>2</sub>	89	15	64,6	18 ÷ 20	5		<b>990.505.11</b>	<b>890.505.11</b>	990.423.00	791.003.00	990.058.00	991.057.00
C <sub>2</sub>	89	15	64,6	18 ÷ 20	5		<b>990.506.11</b>	<b>890.506.11</b>	990.423.00	791.003.00	990.058.00	991.057.00
D	89	15	64,6	15 ÷ 20	5		<b>990.507.11</b>	<b>890.507.11</b>	990.423.00	791.003.00	990.058.00	991.057.00
A <sub>3</sub>	47,6	9,5	58,1	12,7 ÷ 15	10	<b>990.011.11</b>			990.423.00	791.003.00	990.058.00	991.057.00
B <sub>3</sub>	47,6	9,5	58,1	12,7 ÷ 15	10	<b>990.012.11</b>		<b>890.512.11</b>	990.423.00	791.003.00	990.058.00	991.057.00

# Raised Panel Bit with Back Cutter



## 8/990.5



These bits have a back-cutter which allows the routing of both the front and back of the panel in the same cut. An additional 31.7mm diameter bearing ensures increased safety by allowing you to make two shallow passes (only for Ø89mm).

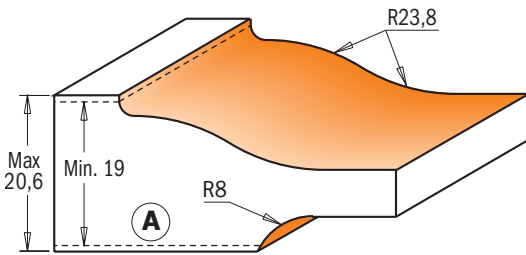
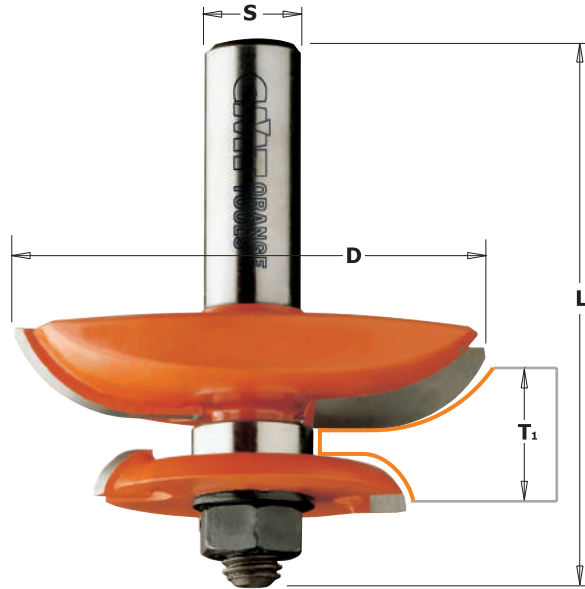

Drawings are 1:1 scale

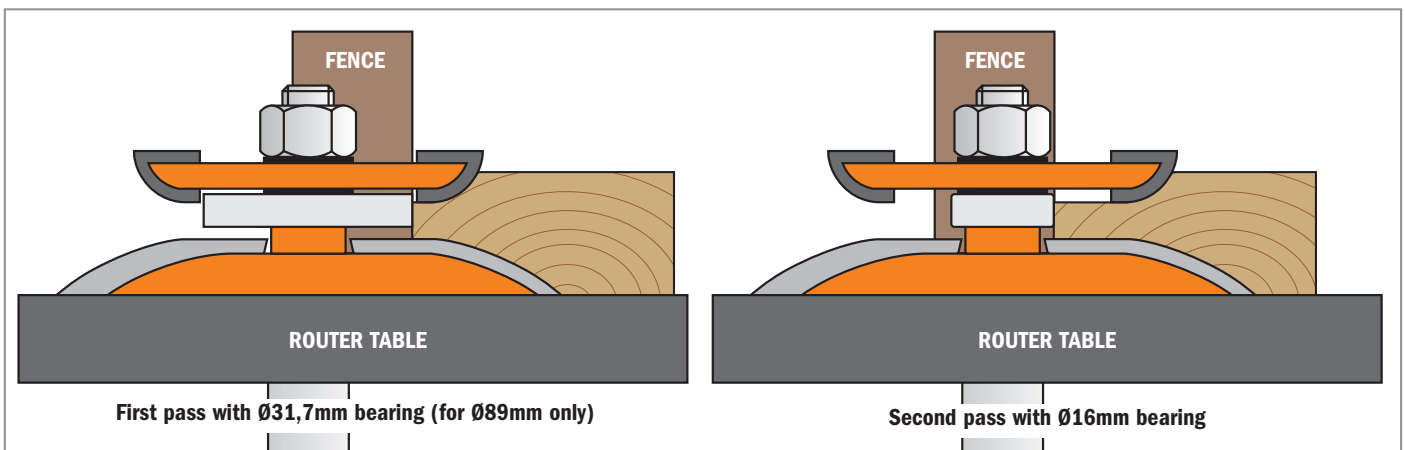
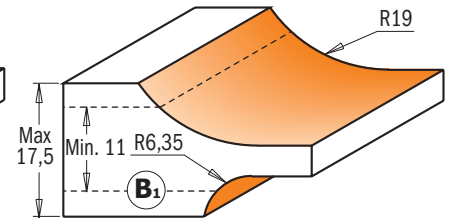
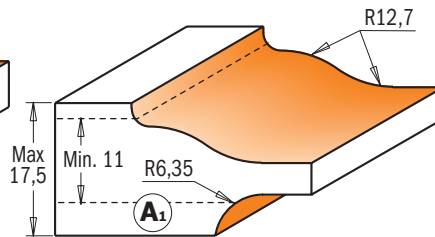
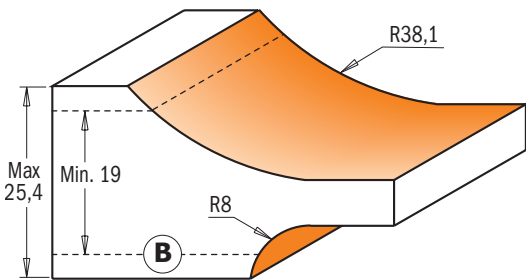

PROFILE	D mm	T <sub>1</sub> mm	L mm		ORDER NO. S=Ø12mm	ORDER NO. S=Ø12,7mm	Spare parts				
A	89	19 - 20,6	78,1	5	<b>990.524.11</b>	<b>890.524.11</b>		16mm	31,7mm		
B	89	19 - 25,4	78,1	5	<b>990.527.11</b>	<b>890.527.11</b>	822.007.11	791.025.00	791.033.00	990.020.00	
A <sub>1</sub>	63,5	11,1 - 17,5	70	5	<b>990.534.11</b>	<b>890.534.11</b>	822.010.11	791.025.00		990.020.00	
B <sub>1</sub>	63,5	11,1 - 17,5	70	5	<b>990.537.11</b>	<b>890.537.11</b>	822.010.11	791.025.00		990.020.00	

Spare parts	541.515.00	0,1mm spacer	541.518.00	1,0mm spacer
	541.516.00	0,3mm spacer	990.407.00	Shield conical



Stile & Panel Router Bits



**8/970**

These bits can be used for decorative work on solid wood panels and MDF materials. Use them in one pass or in combination with CMT's MDF panel bits for complex and intricate profiles. A simple approach for an elegant appearance.

Featuring large cutting diameters and available in the most popular profiles, these panel bits guarantee excellent performance.

**PANEL BITS**

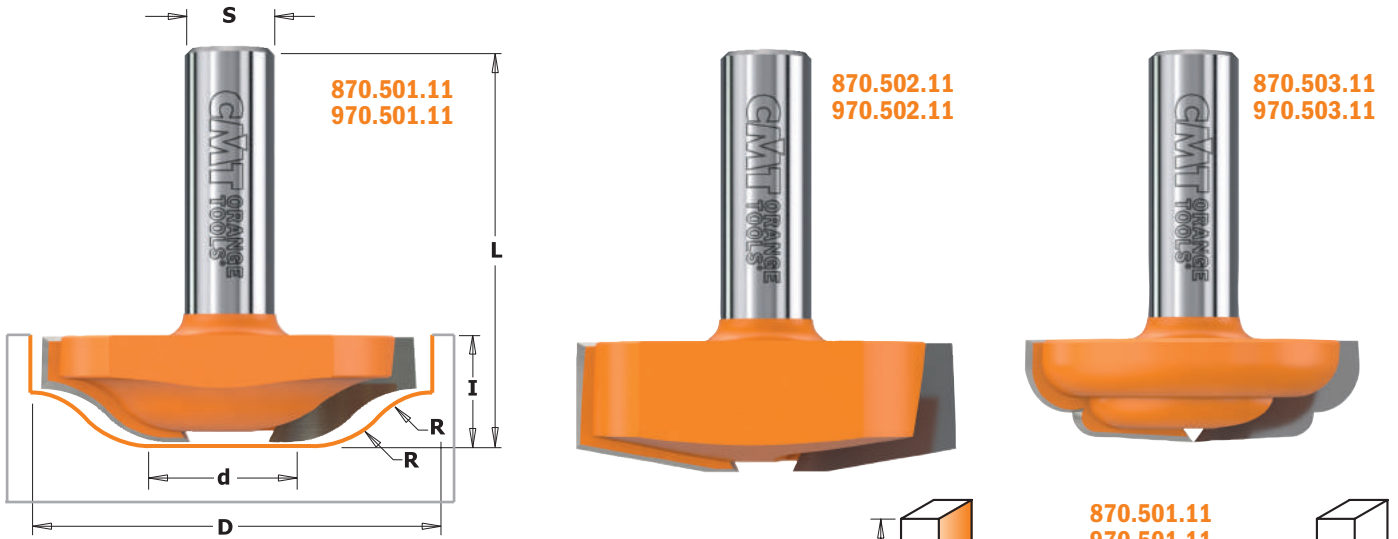

**STILE BITS**

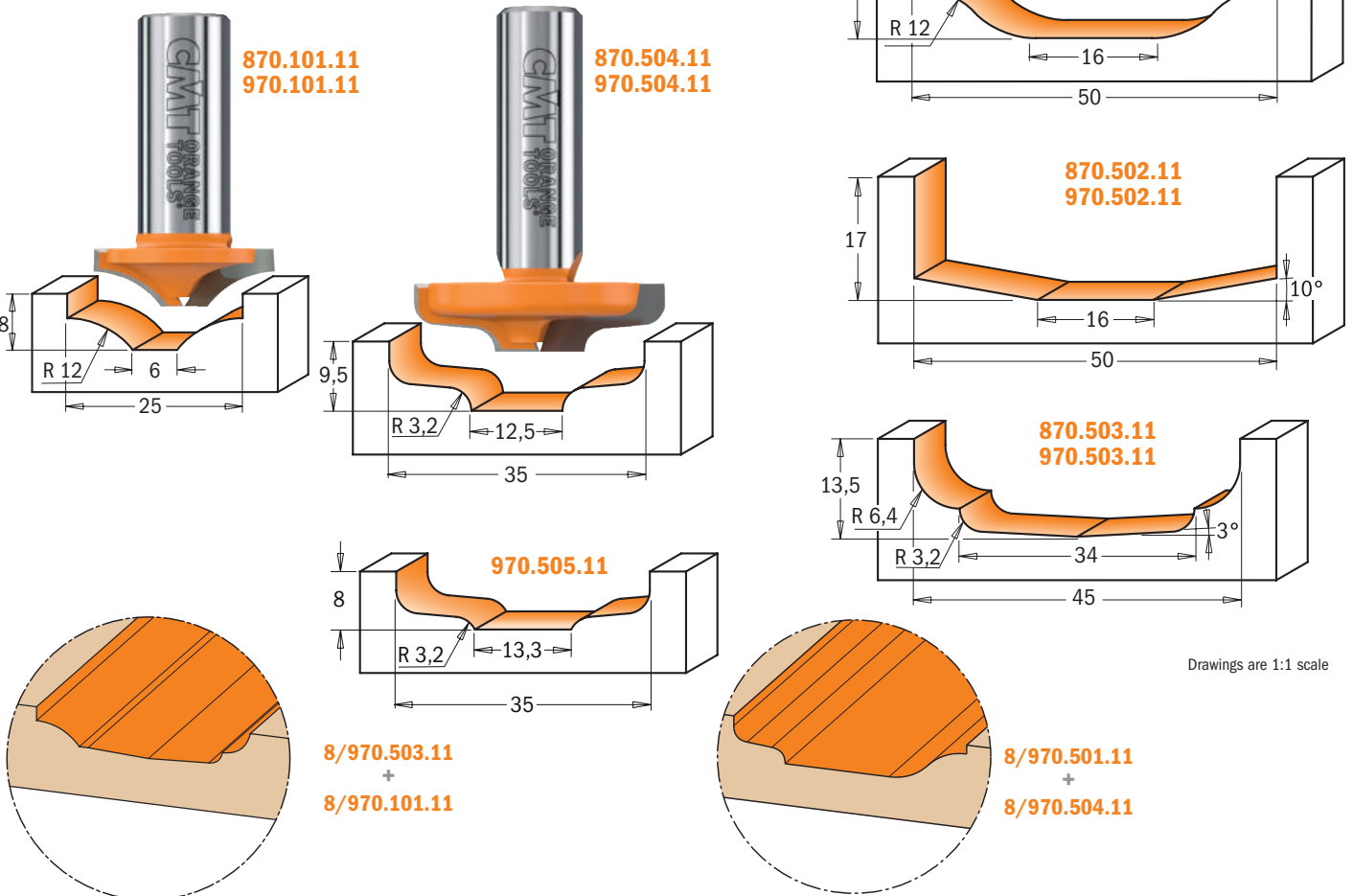

Drawings are 1:1 scale

D mm	d mm	I mm	R mm	A	L mm		ORDER NO. S=Ø8mm	ORDER NO. S=Ø12mm	ORDER NO. S=Ø12,7mm
25	6	8	12		39,8	10	<b>970.101.11</b>		<b>870.101.11</b>
50	16	14	12		52,1	10		<b>970.501.11</b>	<b>870.501.11</b>
50	16	17		10°	55,1	10		<b>970.502.11</b>	<b>870.502.11</b>
45	34	13,5	3,2 - 6,4	3°	51,6	10		<b>970.503.11</b>	<b>870.503.11</b>
35	12,5	9,5	3,2		47,6	10		<b>970.504.11</b>	<b>870.504.11</b>
35	13,3	8	3,2		46	10		<b>970.505.11</b>	

# 3-Flute Slot Cutter for STRIPLOX™ Mini

new

**CMT ORANGE TOOLS®**

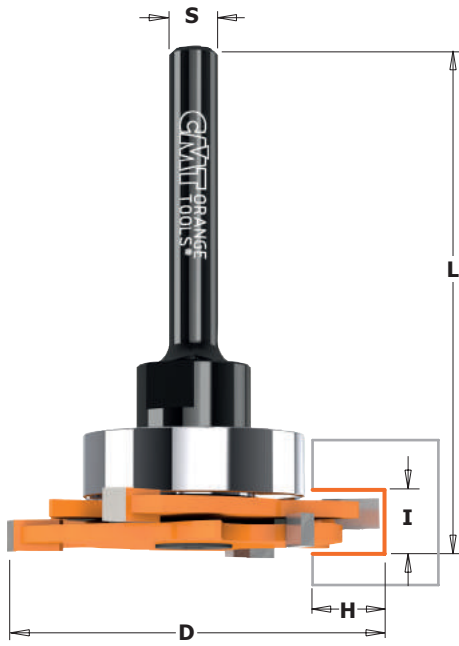

## 823.371

New CMT cutter for Striplox Mini connectors. These connectors are invisible joiner suited to everyday builds, custom cabinets, wood joints and any piece of cabinetry, furniture or design application. They produce a tight and strong joint either in a permanent or reversible configuration making them perfectly suited for commercial, domestic and architectural furniture, kitchen, bathroom and wardrobe closets, cabinetry, commercial fit-outs plus many more applications.

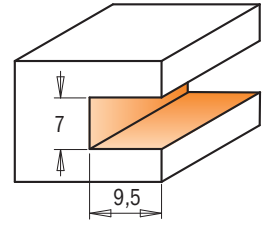





Drawings are 1:1 scale



I mm	D mm	H mm	L mm		ORDER NO.
7	47,6	9,5	65		S=Ø6,35mm <b>823.371.11A</b>

### Spare parts

			
791.030.00	823.340.11	990.055.00	991.067.00

Spare parts

541.515.00	0,1mm spacer
541.516.00	0,3mm spacer
541.517.00	0,5mm spacer

# Solid Surface Counter-Top Trim Router Bits

new

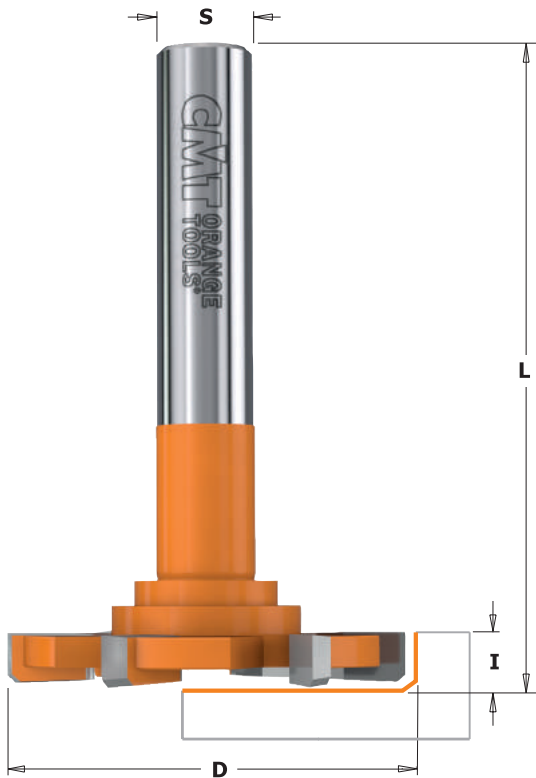

## 822.034

Create extra-smooth shallow recesses in countertops with this 6-wing tool. The radiused cutting tips produce an edge that's easy on the fingers and simple to clean. Use in a handheld router.

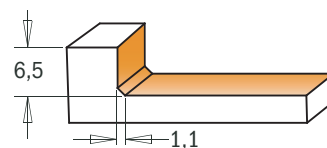

Drawings are 1:1 scale



D mm	I mm	L mm				ORDER NO.	ORDER NO.
52	6,5	83,5				S=Ø12mm <b>922.034.11</b>	S=Ø12,7mm <b>822.034.11</b>

# Solid Surface Rounding Over Bits



## 7/8/938 - 8/980.5

Use these bits to create a traditional roundover edge on solid surface countertops. Equipped with a non-marring Delrin® bearing to protect the finished edges. For use on hand-held portable routers.

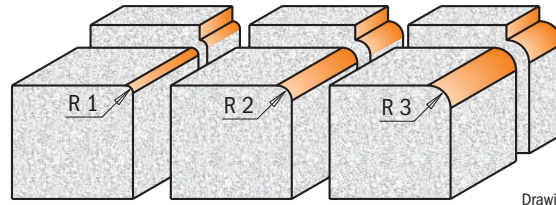

Drawings are 1:1 scale

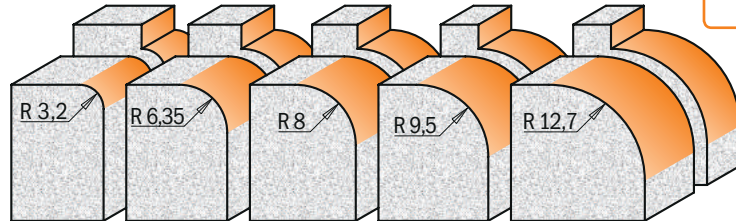

### APPLICATION

Wilsonart®  
Gibraltar®  
Corian®  
Surell®  
Fountainhead®  
Avonite®  
Formica®  
Etc.

R mm	D mm	I mm	L mm	Box	ORDER NO. S=Ø6mm	ORDER NO. S=Ø6,35mm	ORDER NO. S=Ø8mm	ORDER NO. S=Ø12mm	ORDER NO. S=Ø12,7mm	Spare parts		
1	14,7	10	51	10		<b>838.147.11</b>	<b>938.147.11</b>					
2	16,7	12,7	52,5	10	<b>738.167.11</b>		<b>938.167.11</b>			990.422.00	791.044.00	990.058.00
3	18,7	12,7	54	10	<b>738.187.11</b>		<b>938.187.11</b>			990.422.00	791.044.00	990.058.00
3,2	19,05	12,7	59,5	10				<b>980.501.11</b>	<b>880.501.11</b>	990.422.00	791.044.00	990.058.00
6,35	25,4	12,7	59,5	10				<b>980.502.11</b>	<b>880.502.11</b>	990.422.00	791.044.00	990.058.00
8	28,7	15	62,5	10				<b>980.505.11</b>	<b>880.505.11</b>	990.422.00	791.044.00	990.058.00
9,5	31,75	14	61	10				<b>980.503.11</b>	<b>880.503.11</b>	990.422.00	791.044.00	990.058.00
12,7	38,1	19,05	66	10				<b>980.504.11</b>	<b>880.504.11</b>	990.422.00	791.044.00	990.058.00

Spare parts 991.057.00 3/32" hex key

# Solid Surface Decorative Edge Profile Bits

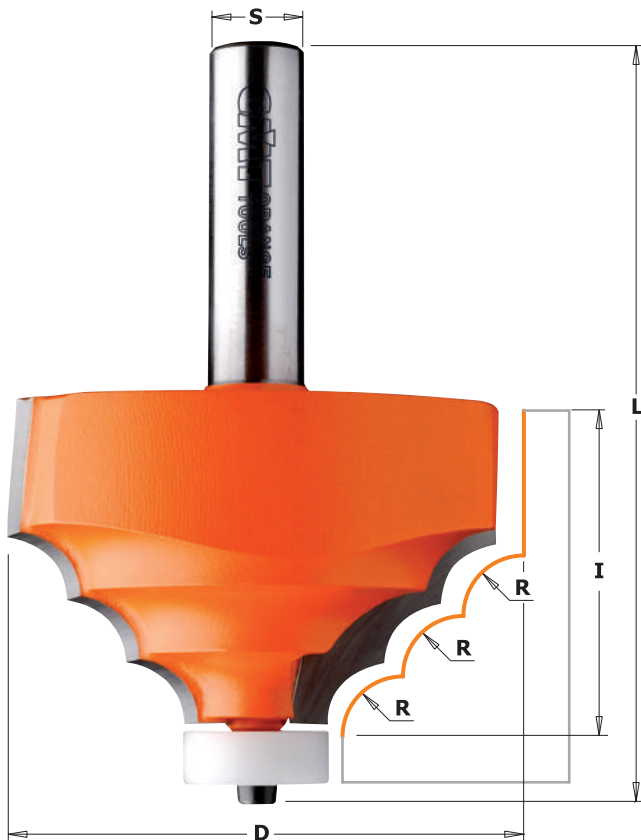

## 8/980.521

Create elegant countertops with flawless results. Features a non-marring Delrin® bearing to protect the finished edges. For use on hand-held portable routers.

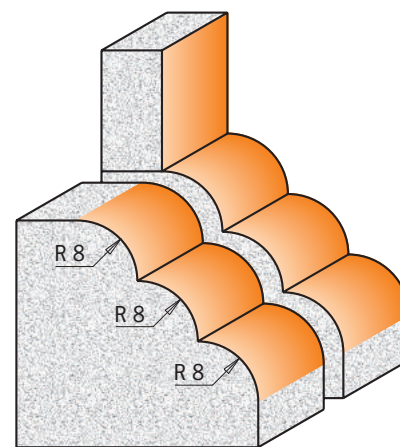

Drawings are 1:1 scale

### APPLICATION

Wilsonart®  
Gibraltar®  
Corian®  
Surell®  
Fountainhead®  
Avonite®  
Formica®  
Etc.

D mm	I mm	R mm	L mm	Box	ORDER NO. S=Ø12mm	ORDER NO. S=Ø12,7mm	Spare parts		
66,7	41,3	8	89,8	5	<b>980.521.11</b>	<b>880.521.11</b>			
							791.046.00	990.058.00	991.057.00



# Solid Surface Rounding Over Bowl Bits

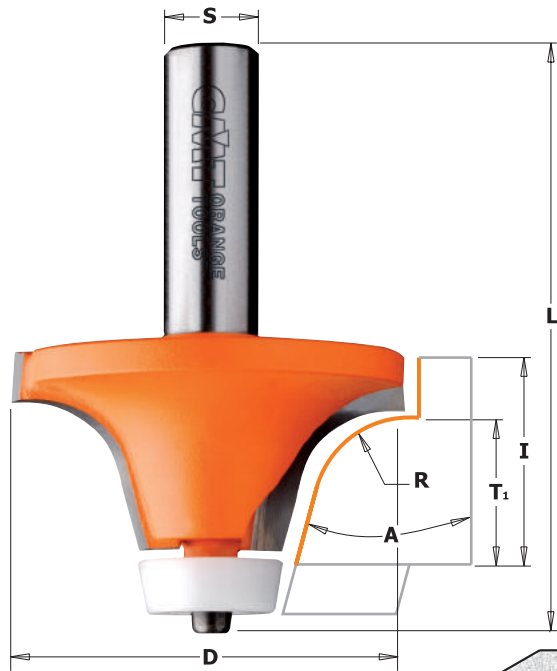

**8/966.601/602**  
**8/980.541**



These bits are the best tool for rounding over and trimming countertop edges after the bowl is mounted. Can be used together with the CMT 880.551.11 bevel cutter for a flush cut-out between the countertop and the installed undermount bowl. For use on hand-held routers. Features a non-marring Delrin® bearing to protect the finished edges.

The special angled Delrin® sleeve on the bearing of the CMT bevel cutter lets you work without leaving marks on the work-piece. Trims and shapes all wood and wood materials. Perfect for kitchen and bathroom countertop work.

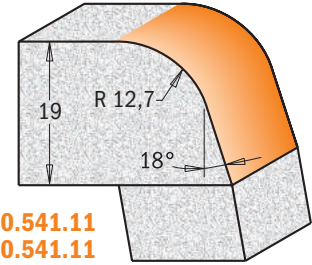

**880.541.11**  
**980.541.11**

Drawings are 1:1 scale

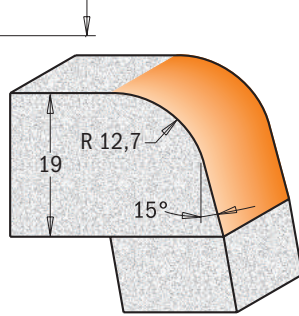

**966.601.11**  
**866.601.11**

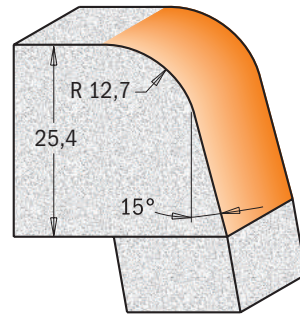

**966.602.11**  
**866.602.11**

### APPLICATION

Wilsonart®  
Gibraltar®  
Corian®  
Surell®  
Fountainhead®  
Avonite®  
Formica®  
Etc.

A	D mm	T <sub>1</sub> mm	I mm	R mm	L mm		ORDER NO. S=Ø12mm	ORDER NO. S=Ø12,7mm	Spare parts		
15°	50,8	19	25,4	12,7	74,9	10	<b>966.601.11</b>	<b>866.601.11</b>			
15°	50,8	25,4	31,75	12,7	81,3	10	<b>966.602.11</b>	<b>866.602.11</b>	791.041.00	990.058.00	991.057.00
18°	54	19	25,4	12,7	78,1	10	<b>980.541.11</b>	<b>880.541.11</b>	791.041.00	990.058.00	991.057.00

# Solid Surface Rounding Over Bowl Bit (ogee profile)

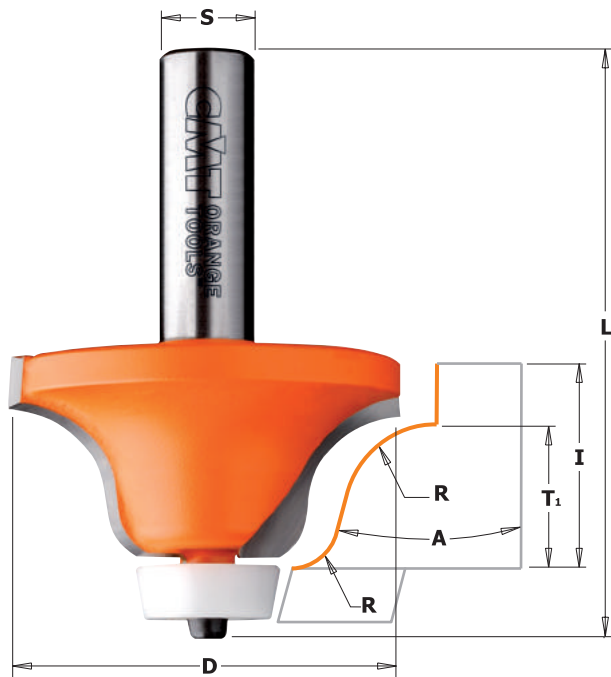

**8/980.542**



These bits roundover and trim the countertop edges after the bowl is mounted. Can be used with the CMT 880.551.11 bevel cutter for a flush cut-out between the countertop and installed undermount bowl. For use on hand-held portable routers. Features a non-marring Delrin® bearing to protect the finished edges.

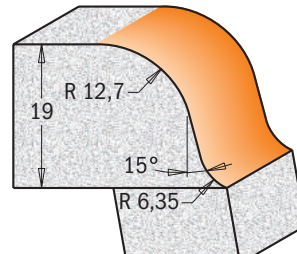

Drawing is 1:1 scale

### APPLICATION

Wilsonart®  
Gibraltar®  
Corian®  
Surell®  
Fountainhead®  
Avonite®  
Formica®  
Etc.

A	D mm	T <sub>1</sub> mm	I mm	R mm	L mm		ORDER NO. S=Ø12mm	ORDER NO. S=Ø12,7mm	Spare parts		
15°	54	19	25,4	6,35-12,7	77,6	10	<b>980.542.11</b>	<b>880.542.11</b>			
									791.041.00	990.058.00	991.057.00

# Solid Surface Bevel Bowl Bits

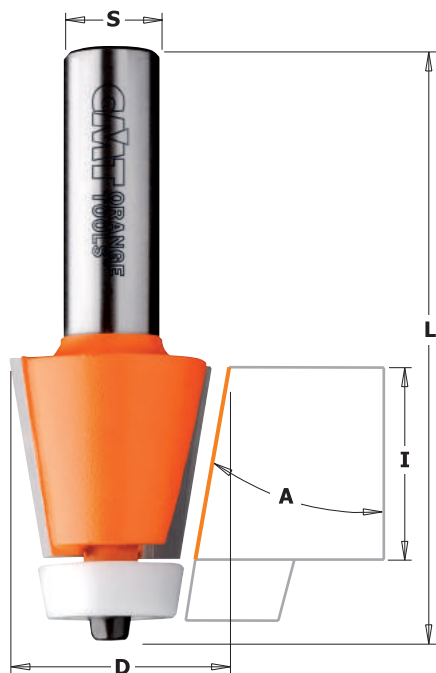

## 8/966.501 - 8/980.551



These bits are designed for undermount applications joining the countertops and sink bowls with a 10° beveled edge. Can be used with the 880.541.11 and 880.542.11 for complete undermount applications. For use on hand-held routers. Features a non-marring Delrin® bearing to protect the finished edges.

Special angled Delrin® sleeve on the bearing of the CMT bevel cutter lets you work without leaving marks on the workpiece. Trims and shapes all wood and wood materials. Perfect for kitchen and bathroom counter top work.

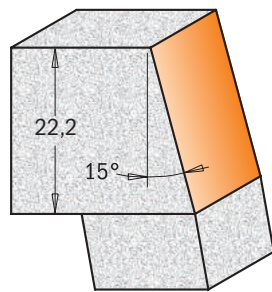

**866.501.11**  
**966.501.11**

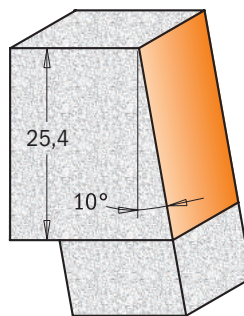

**880.551.11**  
**980.551.11**

Drawings are 1:1 scale

### APPLICATION

Wilsonart®  
Gibraltar®  
Corian®  
Surell®  
Fountainhead®  
Avonite®  
Formica®  
Etc.

A	D mm	I mm	L mm		ORDER NO. S=Ø12mm	ORDER NO. S=Ø12,7mm	Spare parts		
15°	31,7	22,2	72	10	<b>966.501.11</b>	<b>866.501.11</b>			
10°	28,5	25,4	77	10	<b>980.551.11</b>	<b>880.551.11</b>	791.041.00	990.058.00	991.057.00
							791.041.00	990.058.00	991.057.00

# Solid Surface Bevel Bit



## 8/981.521



Edge profile bit designed to create a 15° beveled edge on solid surface countertops. Can also be used for European type topmount installation with sinks and bowls. For use on hand-held portable routers.

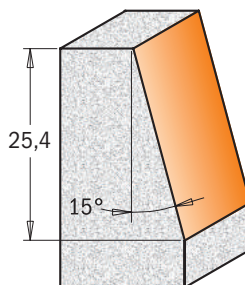

Drawings are 1:1 scale

### APPLICATION

Wilsonart®  
Gibraltar®  
Corian®  
Surell®  
Fountainhead®  
Avonite®  
Formica®  
Etc.

D mm	d mm	I mm	A	L mm		ORDER NO. S=Ø12mm	ORDER NO. S=Ø12,7mm
23	9,52	25,4	15°	63,5	10	<b>981.521.11</b>	<b>881.521.11</b>

# Solid Surface Cut & Plug Repair Set



9/881.541



These special carbide-tipped bits work best on solid surfaces or when repairing damaged surfaces. To repair, create the plug with the plug-cutter first, then use the other bit to easily make the hole. Your surfaces will look like new again! For use with hand-held routers or CNC machines.

**APPLICATION**

Wilsonart®  
Gibraltar®  
Corian®  
Surell®  
Fountainhead®  
Avonite®  
Formica®  
Etc.

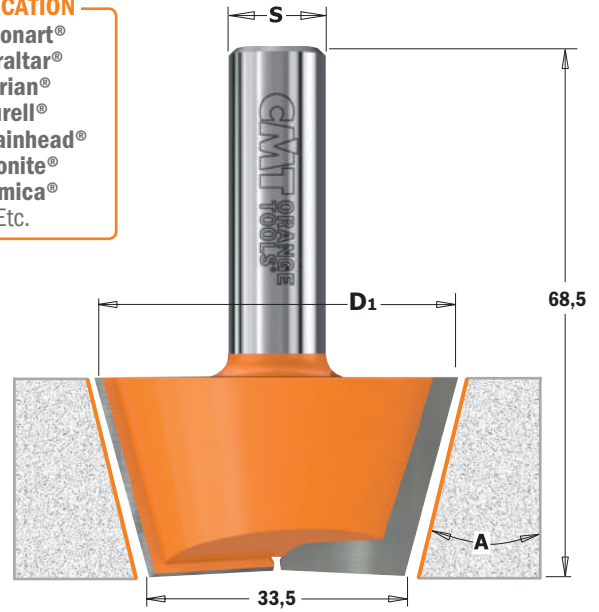
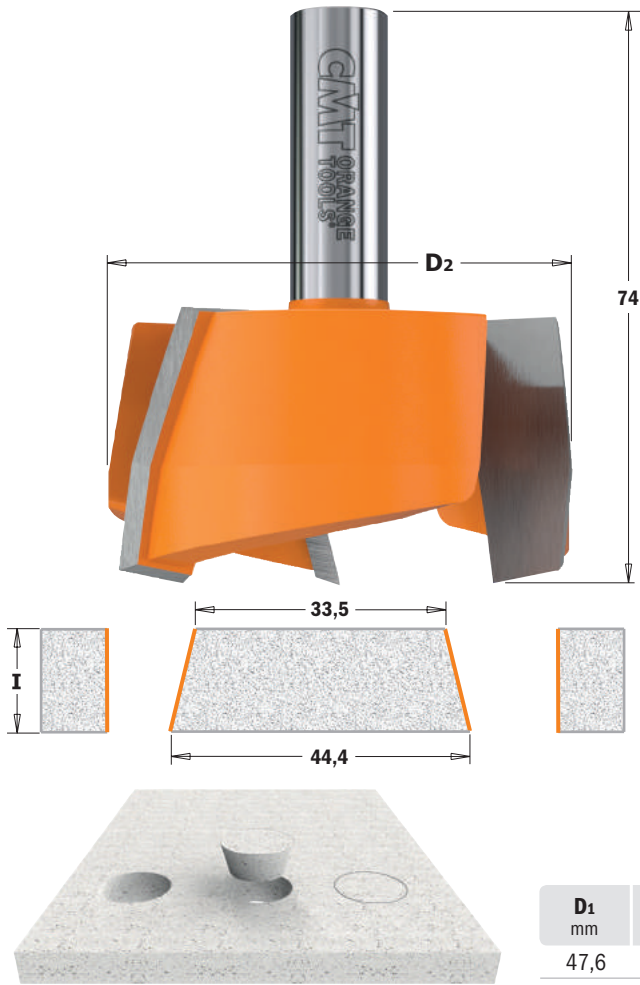

D1 mm	D2 mm	I mm	A	L mm		ORDER NO. S=Ø12mm	ORDER NO. S=Ø12,7mm
47,6	63,5	20	15°	68,5-74	5	981.541.11	881.541.11

# 4-Wing Cut Out Slot Cutters for Solid Surfaces

8/922.033B



This bit features two tungsten carbide-tipped cutting edges for carving out solid surface undermount bowls. For use on hand-held routers. Bit also equipped with a non-marring Delrin® bearing to protect your surfaces.

**APPLICATION**

Wilsonart®  
Gibraltar®  
Corian®  
Surell®  
Fountainhead®  
Avonite®  
Formica®  
Etc.

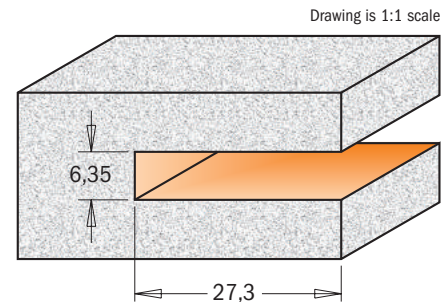
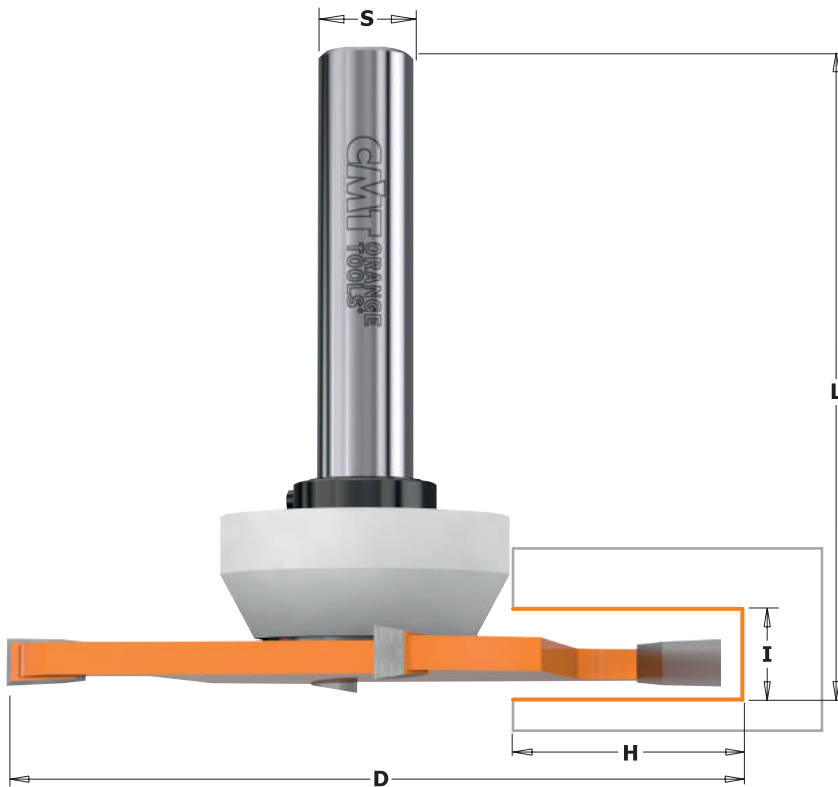

D mm	I mm	H mm	L mm		ORDER NO. S=Ø12mm	ORDER NO. S=Ø12,7mm
92	6,35	27,3	82,5	5	922.033.11B	822.033.11B

**Spare parts**

541.553.00	791.047.00	541.002.00	991.056.00



## Solid Surface No-Drip Bit



### 8/981.501

This bit is designed to create “no-drip” edges on kitchen and vanity countertops. Designed for hand-held portable routers on applications where a guide bearing cannot be used. This one bit will cut both the outer and inner profiles creating a slightly raised edge, controlling spilled liquids.

**APPLICATION**

Wilsonart®  
Gibraltar®  
Corian®  
Surell®  
Fountainhead®  
Avonite®  
Formica®  
Etc.

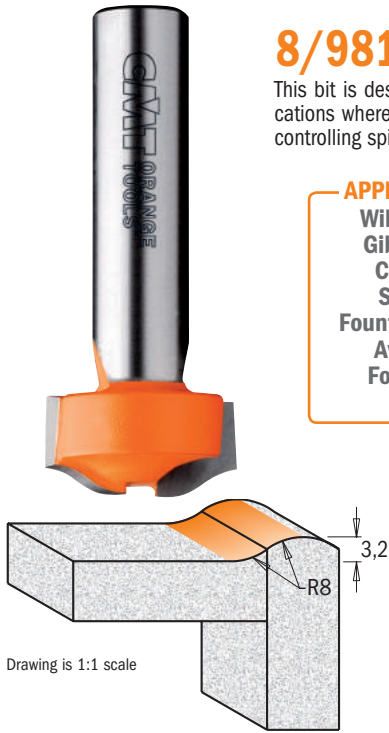

Drawing is 1:1 scale

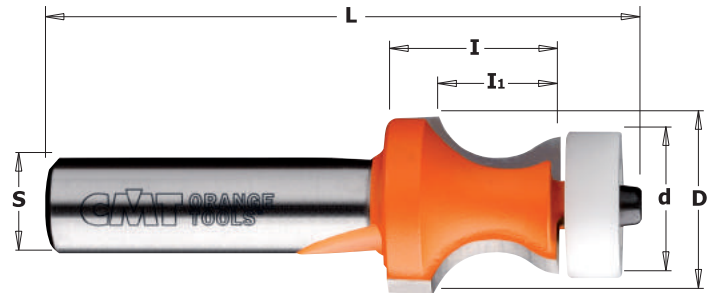

### 8/980.531

This bit is designed to create “no-drip” edges on kitchen and vanity countertops in a single pass. For use on hand-held routers. Creates a slightly raised edge for controlling spilled liquids. Features a non-marring Delrin® bearing to protect your surfaces.

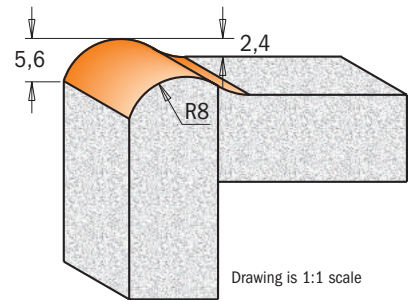

Drawing is 1:1 scale

D mm	d mm	I mm	I <sub>1</sub> mm	R mm	L mm		ORDER NO. S=∅12mm	ORDER NO. S=∅12,7mm
25,4		12,7	3,2	8	63,5		<b>981.501.11</b>	<b>881.501.11</b>
25,4	19	22,2	15,87	8	77		<b>980.531.11</b>	<b>880.531.11</b>

**Spare parts**

791.046.00	990.058.00	991.057.00

## Solid Surface Wavy Joint Bit

### 8/981.531

These bits are ideal for making strong joints on any solid surface, thanks to a wider surface area for glue application.



**APPLICATION**

Wilsonart®  
Gibraltar®  
Corian®  
Surell®  
Fountainhead®  
Avonite®  
Formica®  
Etc.

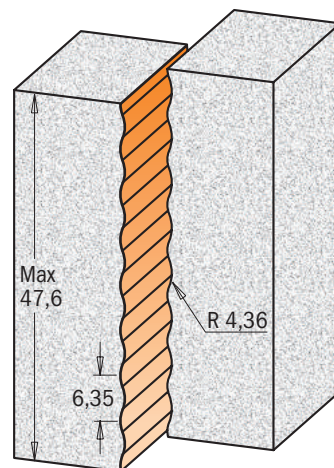
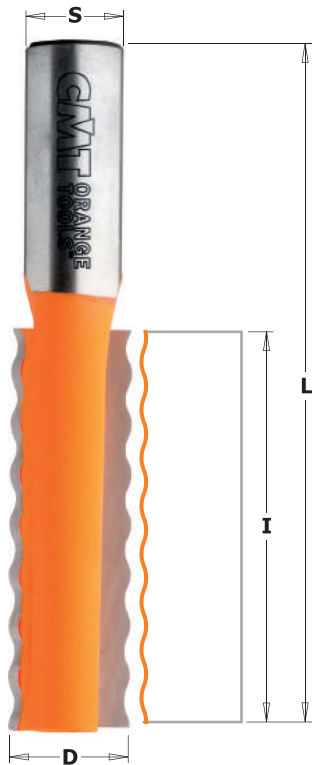

Drawings are 1:1 scale

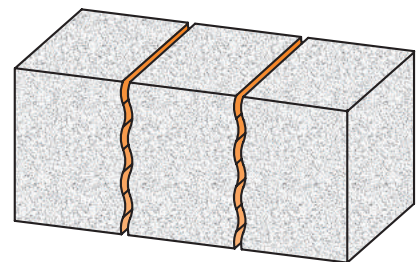

D mm	I mm	R mm	L mm		ORDER NO. S=∅12mm	ORDER NO. S=∅12,7mm
15,87	51,5	4,36	89		<b>981.531.11</b>	<b>881.531.11</b>

# Solid Surface Drainboard Bits



## 8/981.511-512

This bit is ideal for creating custom drainboard patterns in solid surface countertops.  
For use on hand-held portable routers.



### APPLICATION

Wilsonart®  
Gibraltar®  
Corian®  
Surell®  
Fountainhead®  
Avonite®  
Formica®  
Etc.

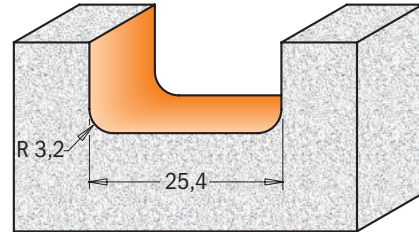
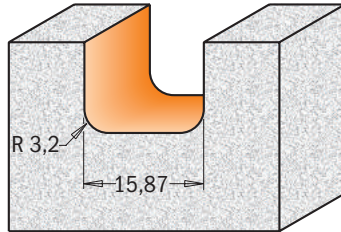

Drawings are 1:1 scale

D mm	I mm	R mm	L mm			ORDER NO. S=∅12mm	ORDER NO. S=∅12,7mm
15,87	12,7	3,2	63,5		10	<b>981.511.11</b>	<b>881.511.11</b>
25,4	12,7	3,2	69,8		10	<b>981.512.11</b>	<b>881.512.11</b>

# Solid Surface - Inlay Bits

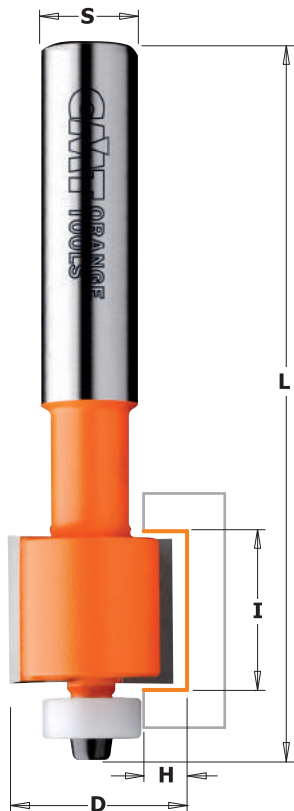

## 8/980.511-512-513

Add a decorative wood, plastic or metal inlay to solid surface countertops.  
Equipped with a non-marring Delrin® bearing to protect the finished edges.  
For use on hand-held portable routers.



### APPLICATION

Wilsonart®  
Gibraltar®  
Corian®  
Surell®  
Fountainhead®  
Avonite®  
Formica®  
Etc.

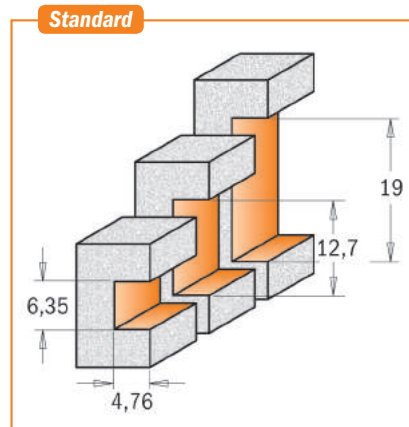

Drawings are 1:1 scale

### Optional

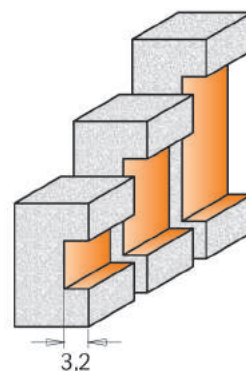

optional with bearing 791.045.00

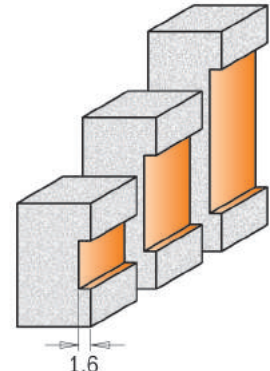

optional with bearing 791.046.00

D mm	I mm	H mm	L mm			ORDER NO. S=∅12mm	ORDER NO. S=∅12,7mm	Spare parts		
22,2	6,35	4,76	77		10	<b>980.511.11</b>	<b>880.511.11</b>			
22,2	12,7	4,76	90		10	<b>980.512.11</b>	<b>880.512.11</b>	791.044.00	990.058.00	991.057.00
22,2	19,05	4,76	90		10	<b>980.513.11</b>	<b>880.513.11</b>	791.044.00	990.058.00	991.057.00

# Solid Surface Sink & Trim Bits



## 8/980.57

Trim a sink cut-out flush with the bowl in stages using these "over-hang" and flush trim bits. The Delrin® bearings are tapered to match the slope of the bowl's side. A first pass with the over-hang bit cleans the cut-out edge, leaving a slight over-hang on the underside of the counter. A second pass with the flush-trim bit completes the operation. Made from super micrograin carbide for guaranteed longer life!

### APPLICATION

Wilsonart®  
Gibraltar®  
Corian®  
Surell®  
Fountainhead®  
Avonite®  
Formica®  
Etc.

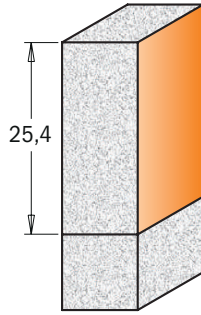

880.571.11  
980.571.11

Drawings are 1:1 scale

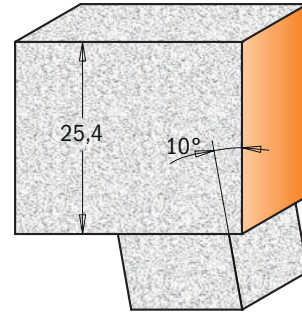

880.572.11  
980.572.11



D mm	I mm	A	L mm		ORDER NO. S=Ø12mm	ORDER NO. S=Ø12,7mm	Spare parts		
19,05	25,4		78		980.571.11	880.571.11			
22	25,4	10°	78	10	980.572.11	880.572.11	791.046.00	990.058.00	991.057.00
							791.048.00	990.058.00	991.057.00

# Solid Surface Sink & Trim Bits with Insert Knives

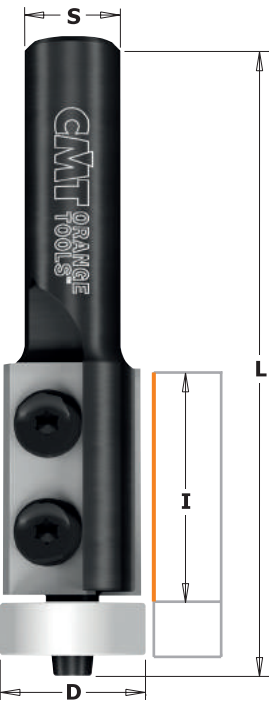

## 8/980.56

Trim a sink cut-out flush with the bowl in stages using these "over-hang" and flush trim bits. The Delrin® bearings are tapered to match the slope of the bowl's side. A first pass with the over-hang bit cleans the cut-out edge, leaving a slight over-hang on the underside of the counter. A second pass with the flush-trim bit completes the operation. Made from super micrograin carbide for guaranteed longer life!

### APPLICATION

Wilsonart®  
Gibraltar®  
Corian®  
Surell®  
Fountainhead®  
Avonite®  
Formica®  
Etc.

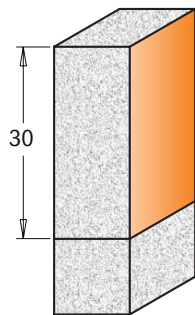

880.561.11  
980.561.11

Drawing is 1:1 scale

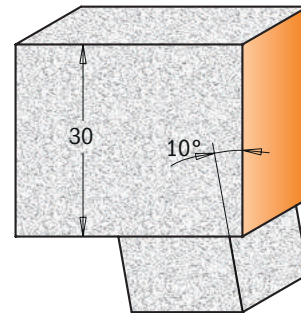
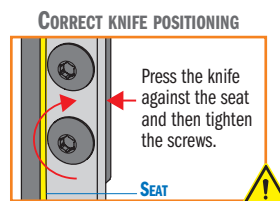

880.562.11  
980.562.11

Drawing is 1:1 scale



D mm	I mm	A	L mm		ORDER NO. S=Ø12mm	ORDER NO. S=Ø12,7mm	Spare parts					
19,05	30		83		980.561.11	880.561.11						
22	30	10°	83	10	980.562.11	880.562.11	790.300.03	990.075.00	991.061.00	791.046.00	990.058.00	991.057.00
							790.300.03	990.075.00	991.061.00	791.048.00	990.058.00	991.057.00



## 26-Piece Router Bit Sets



### 900.003

Find a whole workshop in this practical 26-piece router bit set! Offers a wide selection of the most popular tools including straight bits, flush trim bits, dovetail bits, cove bits, ogee bits and so much more. An endless selection of tools to express your wood-working creativity! Ideal for the master craftsman! Available in 6mm to 8mm shank diameters. See chart below for details.



DESCRIPTION	Box	ORDER NO. S=Ø8mm
26-Piece Router Bit Sets	1	900.003.00

Drawings are 1:1 scale

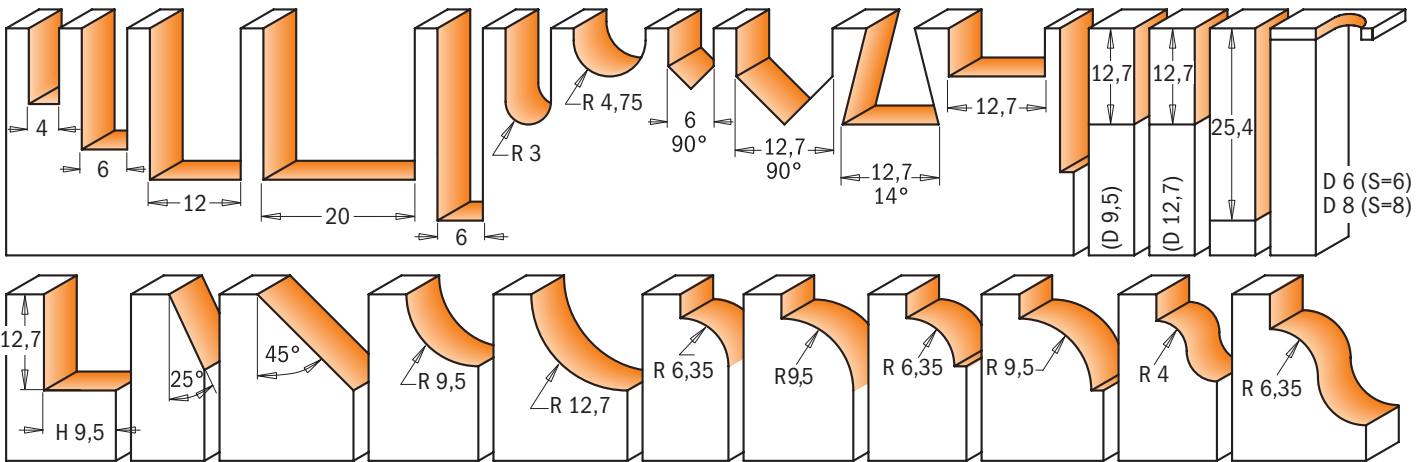

## 15-Piece Router Bit Sets



### 8/900.001

CMT's router bit set is the perfect companion for the professional craftsman. This set offers a selection of organized and ready-to-use straight and profile bits. Added value for any woodworker! Each bit is made with Fatigue Proof® steel, micrograin carbide and is coated with orange non-stick PTFE. Comes with a hardwood snap-lock case for safe storage!



DESCRIPTION	Box	ORDER NO. S=Ø6,35mm	ORDER NO. S=Ø8mm
15-Piece Router Bit Sets	1	800.001.00	900.001.00

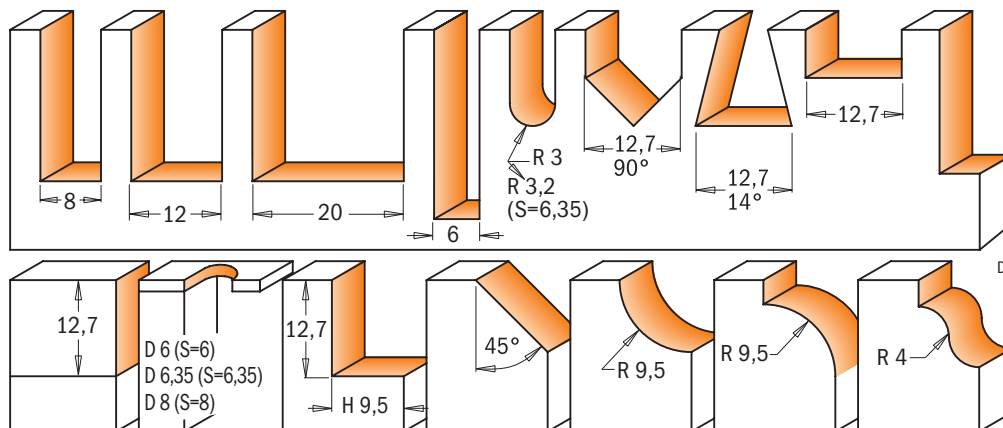

Drawings are 1:1 scale

## 12-Piece Router Bit Sets



**800.503**

CMT's 12 most frequently used 6.35mm shank router bits assembled in a compact and attractive hardwood case for your convenience! The bits are made with the finest steel and carbide and feature our trademark orange PTFE coating. The perfect case for any professional woodworker!



DESCRIPTION	Quantity	ORDER NO.
12-Piece Router Bit Sets	1	S=Ø6,35mm <b>800.503.11</b>

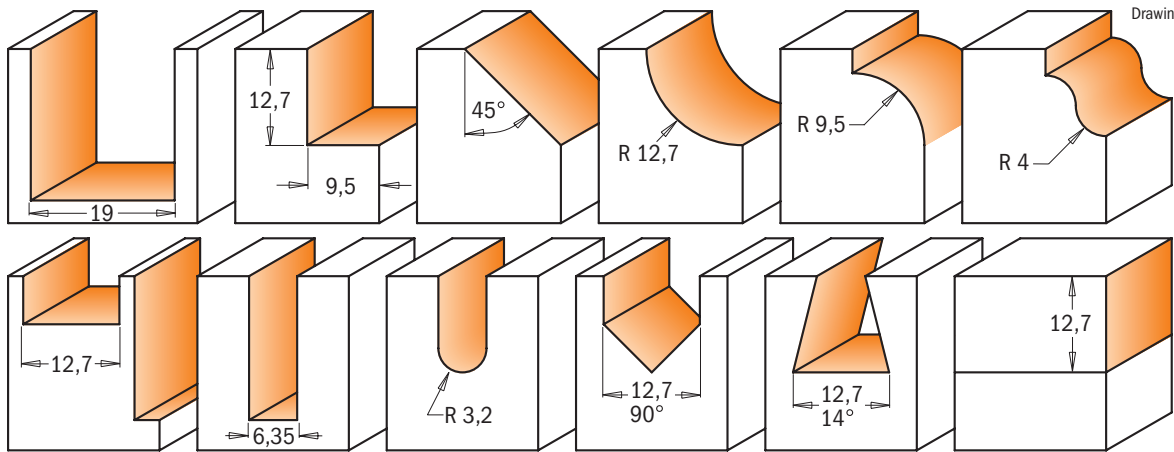

Drawings are 1:1 scale

## 13-Piece Router Bit Sets



**800.505**

CMT's 13 most frequently used 12.7mm shank router bits assembled in a compact and attractive hardwood case for your convenience! The bits are made with the finest steel and carbide and feature our trademark orange PTFE coating. The perfect case for any professional woodworker!



DESCRIPTION	Quantity	ORDER NO.
13-Piece Router Bit Sets	1	S=Ø12,7mm <b>800.505.11</b>

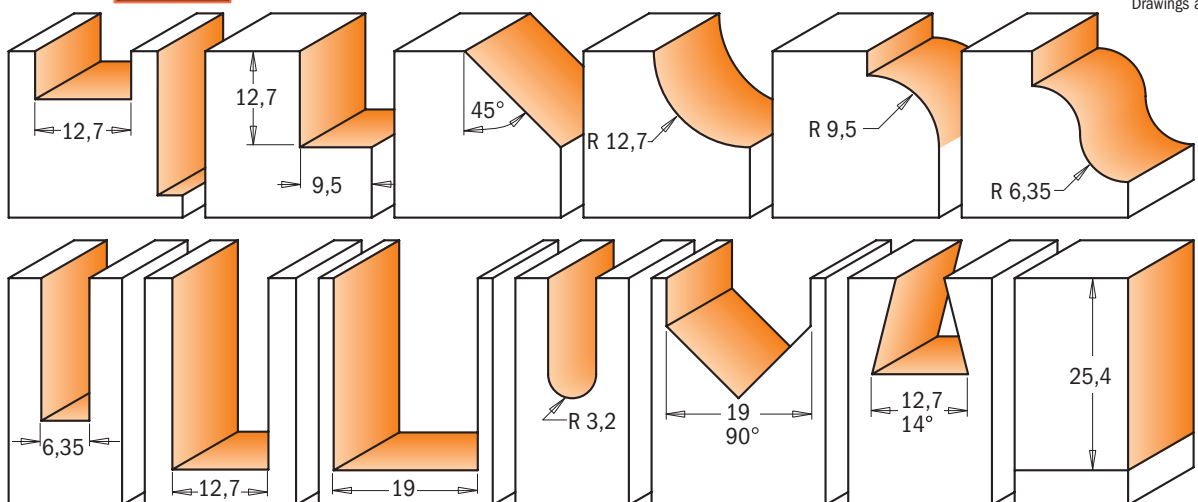

Drawings are 1:1 scale

## Divided Light Door Sets



**800.525 - 900.025**



Build authentic divided light doors for fine furniture and cabinets with these 3-piece sets. They include a stuck bit to cut the decorative ovolo profile on the frame edges, a cope to shape the mating profile on the ends of the stock, and a rabbeting bit to cut the recess for the glass. Thanks to the guide bearings, you can also create arches on curved frames. The unique design of the cope bit allows you to use full-length tenons to create strong, authentic mortise-and-tenon joinery. As the stock is coped, the tenon passes over the bit. These sets are designed for 22,2mm wide bars such as those on corner cupboard doors. Available in 8mm and 12,7mm shanks. Instructions included.

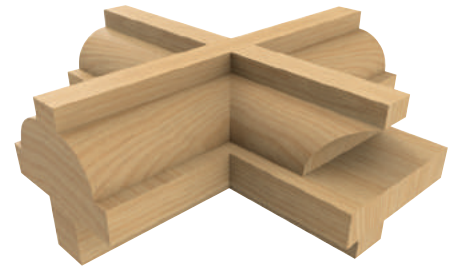

DESCRIPTION	1	ORDER NO. S=Ø8mm	ORDER NO. S=Ø12,7mm
Divided Light Door Sets		<b>900.025.11</b>	<b>800.525.11</b>

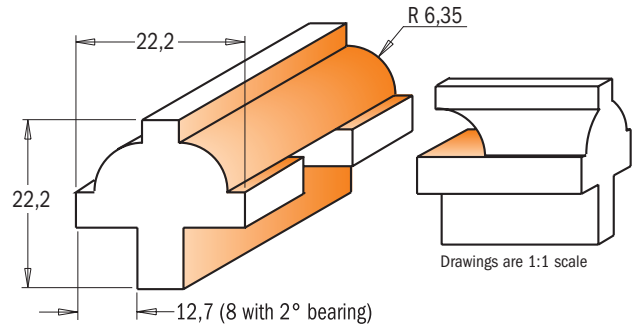

## Glass Panel Sets



**8/955.803**



CMT's unique stile and rail router bit sets allow you to produce glass panel doors by using a rubber panel retainers to secure the glass in a 3,2mm slot cut into the frames. These bits work the same as other CMT stile and rail sets, but they leave you with a square rabbet on the inside of your door for installing the glass panel. Available in 12mm and 12,7mm shanks.

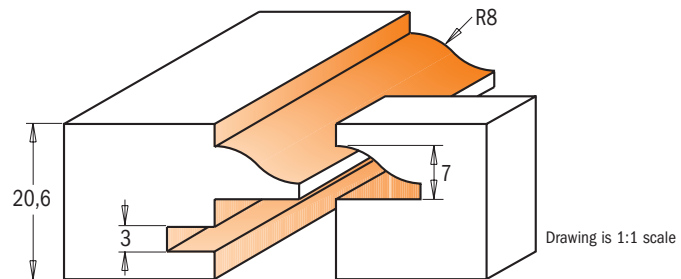

DESCRIPTION	1	ORDER NO. S=Ø12mm	ORDER NO. S=Ø12,7mm
Glass Panel Sets		<b>955.803.11</b>	<b>855.803.11</b>

**Optional** GLAS/RTBRN Glass panel retainers 762cm.

### GLASS PANEL RETAINERS

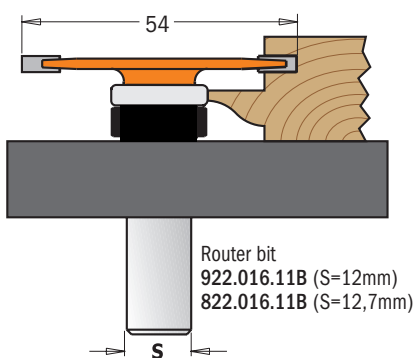

#### HERE'S HOW IT WORKS:

Mill the cope and pattern cuts first, then use the slot cutter to cut the groove for the rubber panel retainer. The edge of the pattern cut will ride on the bearing of the slot cutter bit. When you cut the slot in the rails you can cut the slot the full length of the stock. When you cut the slot in the stiles you need to set up reference points to stop and start the cuts so they are hidden from view on the top and bottom of the doors.

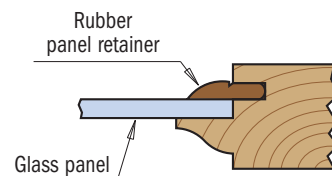

### GLAS/RTBRN

Our unique retainer strips fit perfectly in the slots created by the slot cutter bit and hold your glass securely in the frame. Sold in 762cm. lengths.



# 6-Piece Profile Bit Sets



## 800.504



Containing 6 of CMT's most frequently used 12,7mm shank router bits, this compact Italian hardwood case is beautiful and convenient for your woodworking needs. All the bits contained feature the finest steel and carbide, plus CMT's baked-on orange PTFE non-stick coating.

DESCRIPTION		ORDER NO.
6-Piece Router Bit Sets	1	S=Ø12,7mm <b>800.504.11</b>

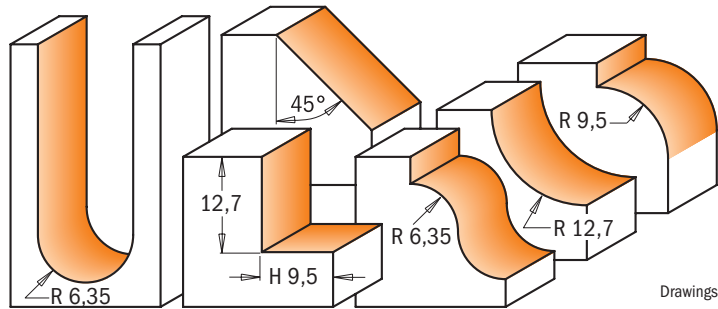

Drawings are 1:1 scale

# Entry & Interior Door Router Bit Set



## 8/900.527



This CMT three-piece router bit set simplifies door construction, making it easy as 1-2-3! In fact this is a multifunctional set for door and furniture makers, building entry or passage doors and any furniture tenons. The tenon cutter included in the set, produces a beefy 27mm long tenon. Along with the cope cutter, this means you can craft long and strong tenons with minimum setup. As an extra bonus, the tenon cutter can be used for making furniture requiring tenons anywhere from 4.7mm to 16mm in thickness.



### Entry & interior door construction Easy as 1, 2, 3!

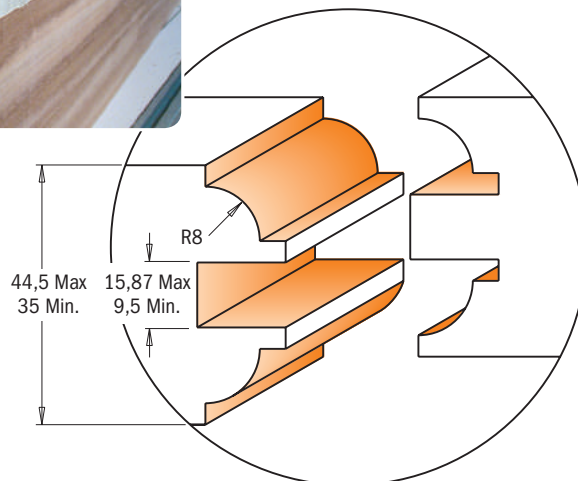
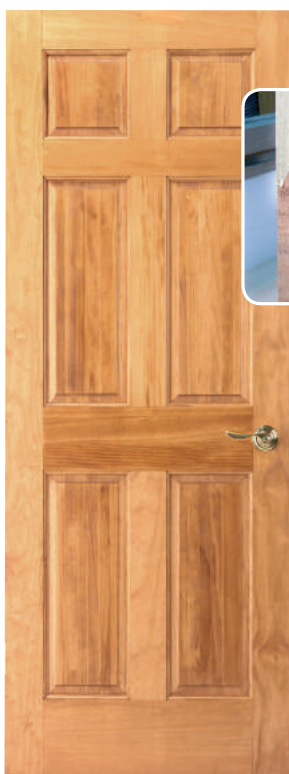
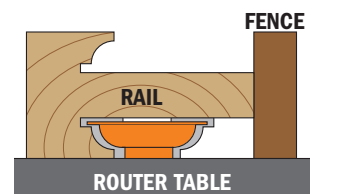
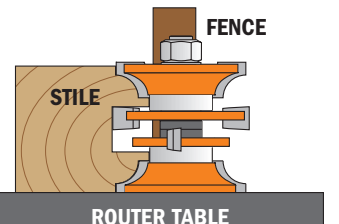
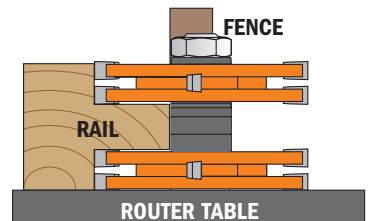

DESCRIPTION		ORDER NO.	ORDER NO.
3-Piece Entry & Interior Door Router Bit Set	1	S=Ø12mm <b>900.527.11</b>	S=Ø12,7mm <b>800.527.11</b>

## 2-Piece Entry Door Router Bit Set



**8/955.806**

These bits allow you to create tongue-and-groove joints and produce entry and passage doors with minimal effort. The bit on the left, when used in pair with the bit 800.628.11, is great for producing long and beefy tenons, whereas the other tool makes the decorating profile.

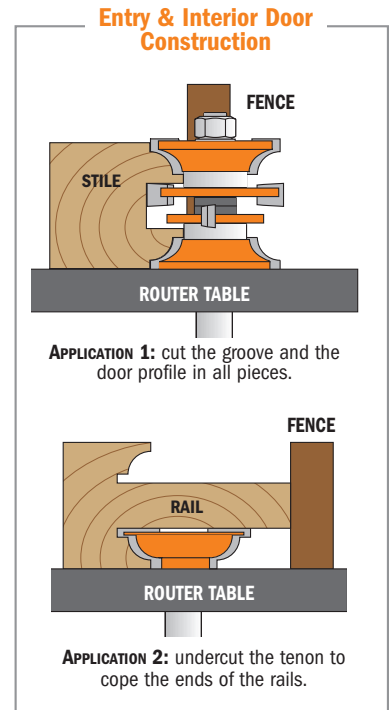
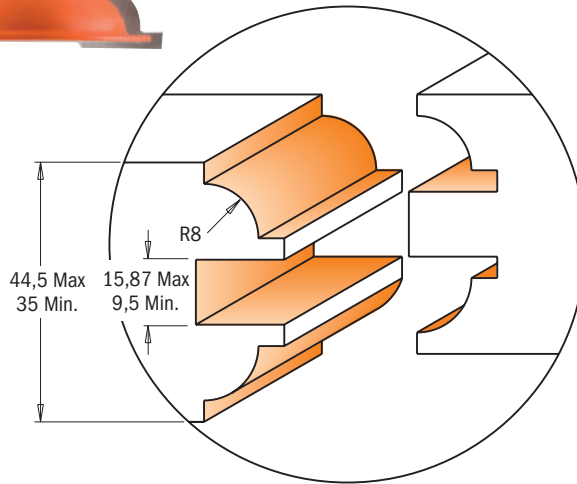

D mm	I mm	Box	ORDER NO. S=Ø12mm	ORDER NO. S=Ø12,7mm	Spare parts							
44,5-48	35-44,5	5	<b>955.806.11</b>	<b>855.806.11</b>	8-22mm	up	down		0,1mm	0,3mm	3mm	
					791.005.00	822.021.11A	822.021.11B	822.022.11	541.515.00	541.516.00	541.500.00	990.020.00

## Tenon Cutting Router Bits

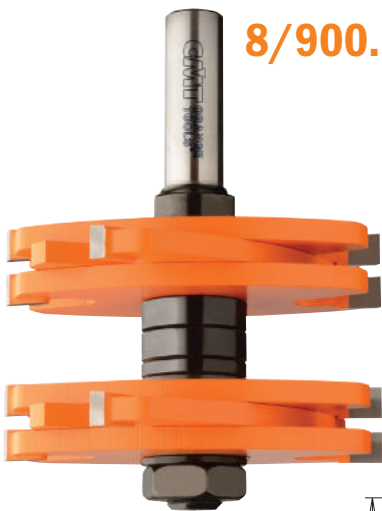

**8/900.628**



**8/900.627**



If you've struggled with adjusting tenons, we've got the perfect solution for you! CMT's tenon cutting router bit will produce the most perfect fitting tenons in every board you cut, even if the boards vary in thickness. Simply set the distance between the cutters using the included spacers, and you can easily cut tenons from 4,76mm (3/16") to 9,5mm (3/8") thick, up to 27mm (1-1/16") long. This simple-to-use router bit takes the mystery out of achieving the excellent tenon-to-mortise fit required for high quality joinery.

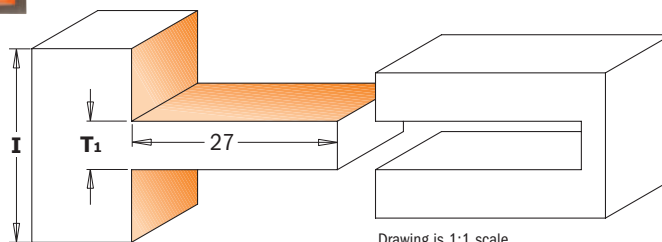

**8-900.627**

T1	Spacers (mm)		
	6,35mm	3,2mm	1,6mm
4,76mm	1	0	0
6,35mm	1	0	1
8mm	1	1	0
9,5mm	1	1	1

Maximum speed  
MAX RPM 12.000

D mm	I mm	T1 mm	Box	ORDER NO. S=Ø12mm	ORDER NO. S=Ø12,7mm	Spare parts							
75	34,9	4,76-9,5	5	<b>900.627.11</b>		924.134.00	822.020.11	541.513.00	541.520.00	541.521.00	541.522.00	541.523.00	990.022.00
75	34,9	4,76-9,5	5		<b>800.627.11</b>	824.134.00	822.020.11	541.513.00	541.520.00	541.521.00	541.522.00	541.523.00	990.022.00
75	44,5	9,5-15,8	5	<b>900.628.11</b>		924.135.00	822.020.11	541.513.00	541.520.00	541.521.00	541.522.00	541.523.00	990.022.00
75	44,5	9,5-15,8	5		<b>800.628.11</b>	824.135.00	822.020.11	541.513.00	541.520.00	541.521.00	541.522.00	541.523.00	990.022.00





Available with raised panel bits in two different profiles, these sets feature six router bits for making arched raised panel doors and professional drawer fronts. These sets include:

**OGEE RAIL & STILE BITS:** these two perfectly matched tools will eliminate the frustration of setting up reversible cutters. The stile bits also feature shear angles for neater cuts.

**RAISED PANEL BIT WITH BACKCUTTER:** this 88,9mm diameter bit features a backcutter for milling both the front and the back on the panel in a single cut. We recommend using a 31mm diameter bearing to work safely in two shallow passes.

**SUPER-DUTY FLUSH TRIM BIT:** this 19mm diameter bit gives you a superior cut with minimal chipping, even on end grain.

**OGEE DOOR EDGE BIT:** a subtle cove followed by a subtle roundover adds an elegant touch to your door edge.

**DRAWER FRONT BIT:** this bit makes a mini-raised panel cut on the outside edges of your drawer fronts.

DESCRIPTION		ORDER NO. S=Ø12,7mm
The Cabinetmaking Sets - Profile A (6 HW pcs.)	1	<b>800.515.11</b>
The Cabinetmaking Sets - Profile B (6 HW pcs.)	1	<b>800.520.11</b>

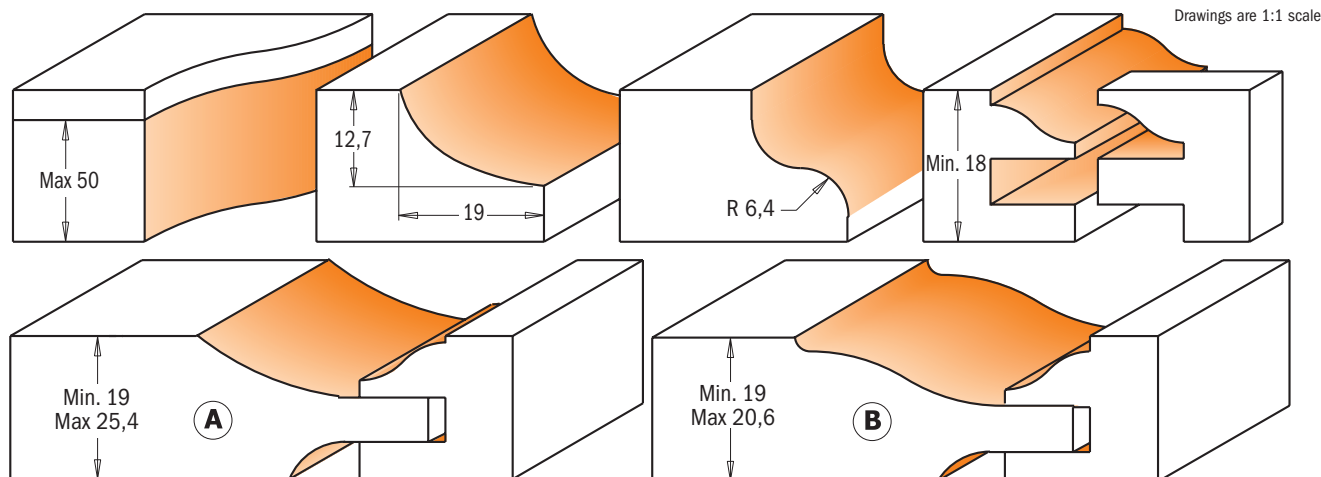

## Small Arch Door Sets



### 800.524 - 900.024



These 3-piece sets will produce beautifully raised panel doors with a classic bevelled profile. Designed for use in fine furniture making, these sets include two matched cope and stick bits to produce frames from 15,87mm to 19mm in thickness. The stick bit shapes a decorative 4,76mm thumbnail moulding along the edge of the frame. The panel bit is designed for 12,7mm thick material. All bits are equipped with guide bearings for shaping curved work such as the small arched panel doors seen on secretaries and corner cabinetry. These sets also produce panels for small chests, lids for small boxes, or drawer fronts. Instructions included.

DESCRIPTION		ORDER NO. S=Ø8mm	ORDER NO. S=Ø12,7mm
Small Arch Door Sets (3 HW pcs.)	1	<b>900.024.11</b>	<b>800.524.11</b>

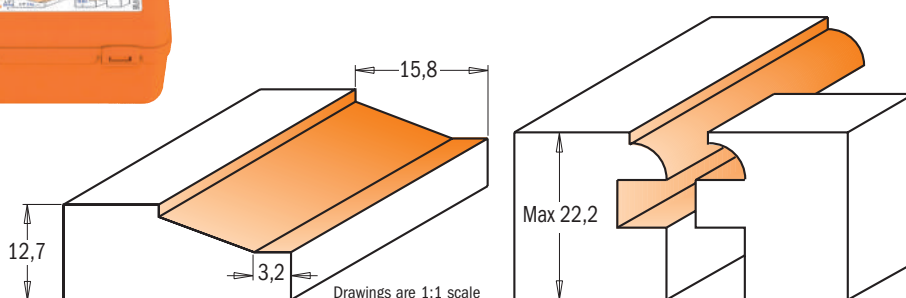



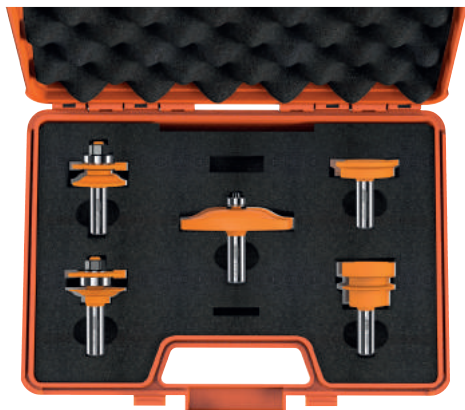

These CMT's sets aren't only a random selection of odds and ends packaged in a nice elegant box, but they are also professional kits for drawer and door makers. 3 sets to choose from, 5 different bits to suit your needs: a raised panel bit, rail and stile bits, a glue joint and a drawer lock bit. Please refer to the illustrations below for complete profile options.



Drawings are 1:1 scale

## 8/900.509.11

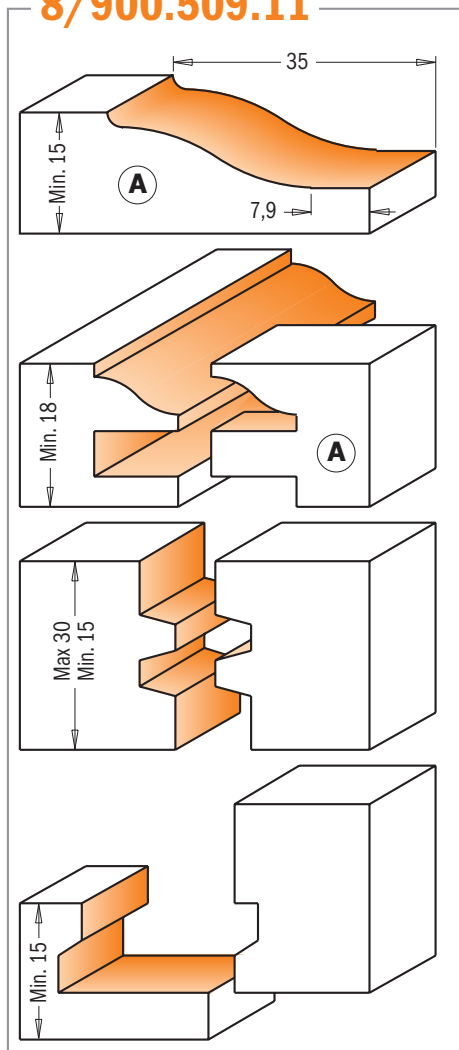

## 8/900.510.11

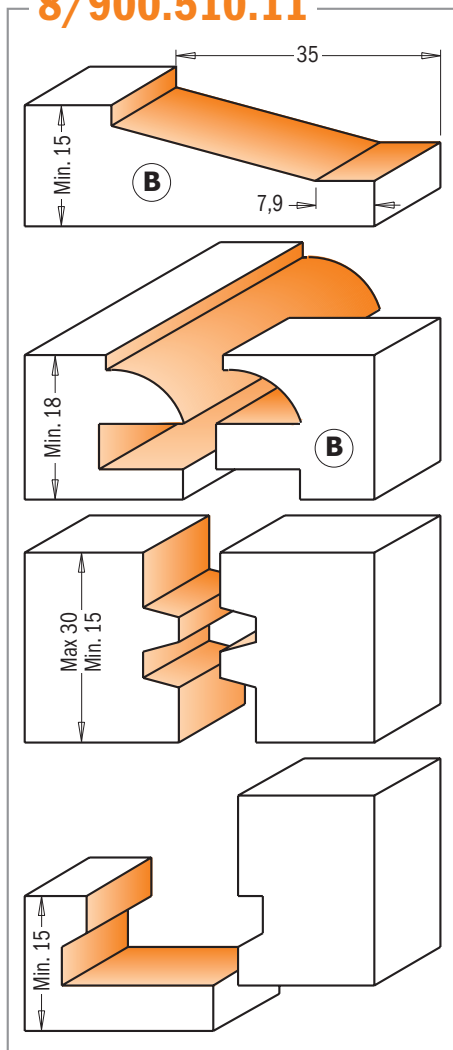

## 8/900.511.11

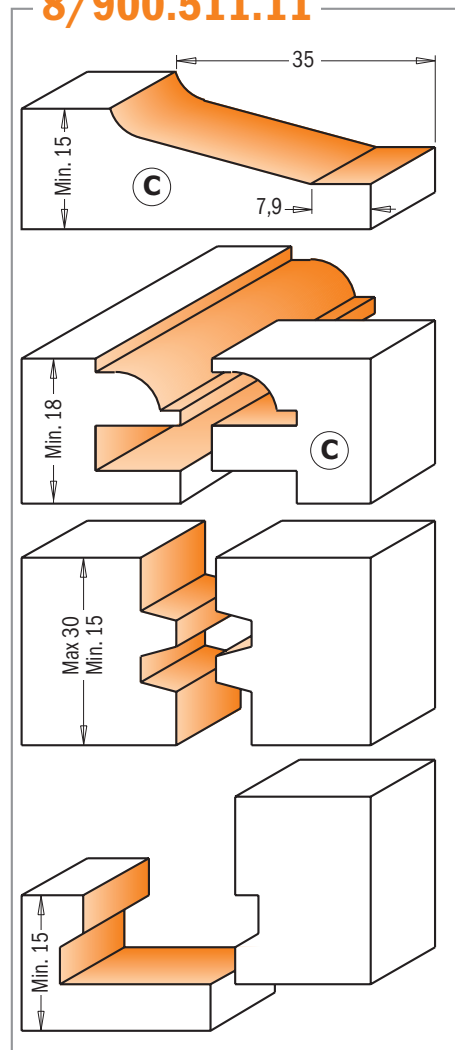

DESCRIPTION		ORDER NO. S=∅12mm	ORDER NO. S=∅12,7mm
CMT's Complete Kitchen Set - Profile A (5 HW pcs.)	1	<b>900.509.11</b>	<b>800.509.11</b>
CMT's Complete Kitchen Set - Profile B (5 HW pcs.)	1	<b>900.510.11</b>	<b>800.510.11</b>
CMT's Complete Kitchen Set - Profile C (5 HW pcs.)	1	<b>900.511.11</b>	<b>800.511.11</b>

## Panalign Strips

Beautiful panel doors can be ruined by a poorly-aligned panel. Next time, slip panalign strips into the rails to keep panels perfectly centred while allowing for expansion. Unlike carpet foam, which eventually loses elasticity and ceases to work, the rubber in panalign strips is specially designed to spring back indefinitely. The rectangular shape makes the strips easy to handle. Typical doors require 4 to 8 strips each.

DESCRIPTION	DIMENSION mm	QTY.		ORDER NO.
Panalign Strips	27x7x7mm	200	1	<b>PNL-001</b>

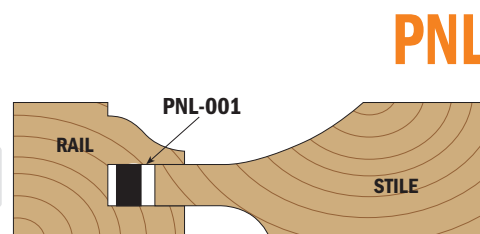

# PNL



Our 3 piece kitchen set includes a couple of rail and stile bits and a raised panel bit. Choose among 4 possible profiles to make panel doors easily economically. Each bit is made from bar stock steel and the highest quality tungsten carbide, along with the trademark orange non-stick PTFE coating. Also, they all come with their protective hardwood case: perfect for keeping your bits safe, organized and within reach.

Drawings are 1:1 scale

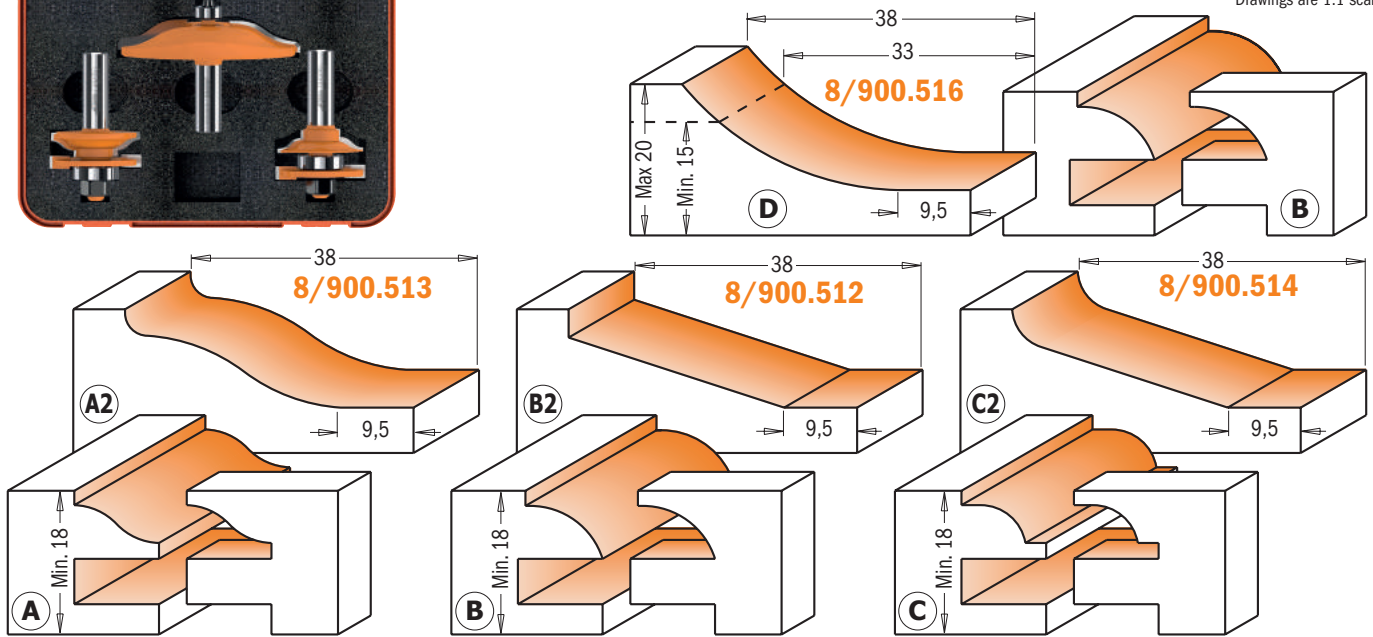

DESCRIPTION		ORDER NO. S=Ø12mm	ORDER NO. S=Ø12,7mm
Kitchen Set - Profile A+A <sub>2</sub>	1	<b>900.513.11</b>	<b>800.513.11</b>
Kitchen Set - Profile B+B <sub>2</sub>	1	<b>900.512.11</b>	<b>800.512.11</b>
Kitchen Set - Profile C+C <sub>2</sub>	1	<b>900.514.11</b>	<b>800.514.11</b>
Kitchen Set - Profile D+B	1	<b>900.516.11</b>	<b>800.516.11</b>

## The Raised Panel Sets with Backcutter



8/900.518 - 8/900.522

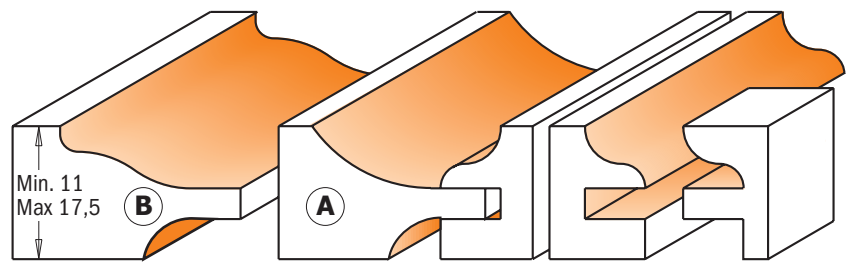

8/900.517 - 8/900.521

Drawings are 1:1 scale

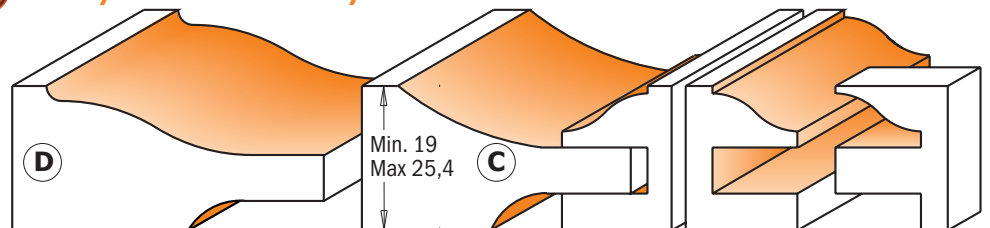

CMT's junior raised panel sets add intricate detail on a whole new scale! You will make frame and panel details as small as 70mm square in material as thin as 11mm. Delicate panel doors are only the beginning - use these bits with templates to add interesting arches to your work. The sets include a choice of a cove or an ogee raised panel bit and an ogee rail & stile pair.

DESCRIPTION		ORDER NO. S=Ø12mm	ORDER NO. S=Ø12,7mm
Junior Raised Panel Sets - Profile A (3 HW pcs.) Ø63,5mm.	1	<b>900.518.11</b>	<b>800.518.11</b>
Junior Raised Panel Sets - Profile B (3 HW pcs.) Ø63,5mm.	1	<b>900.522.11</b>	<b>800.522.11</b>
Raised Panel Sets - Profile C (3 HW pcs.) Ø89mm.	1	<b>900.517.11</b>	<b>800.517.11</b>
Raised Panel Sets - Profile D (3 HW pcs.) Ø89mm.	1	<b>900.521.11</b>	<b>800.521.11</b>

# Adjustable Shaker Router Bit Sets



## 8/900.624



These new bit sets are excellent for producing adjustable tongue and groove joints with a bevel, in order to eliminate panel rattle that may occur with the production of standard cabinets. Cut precise grooves into your plywood veneered panels and make perfect rattle-free fits. To be used on table-mounted routers. Avoid using these bits in hand-held power tools.

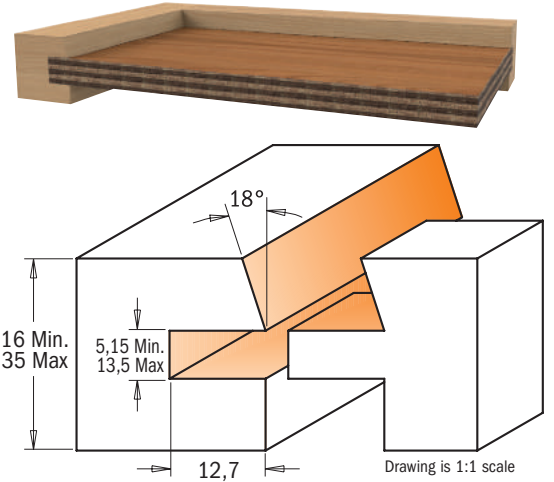

D mm	T <sub>1</sub> mm	A	L mm	Box	ORDER NO. S=Ø12mm	ORDER NO. S=Ø12,7mm
41,2	16 - 35	18°	87	5	<b>900.624.11</b>	<b>800.624.11</b>

Spare parts						
791.025.00	822.025.11	822.026.11	822.027.11	822.028.11	990.020.00	

<b>Spare parts</b>	541.515.00	0,1mm spacer	541.518.00	1mm spacer
	541.516.00	0,3mm spacer	541.500.00	3mm spacer
	541.517.00	0,5mm spacer	541.519.00	5,8mm spacer

# Adjustable Tongue & Groove Bit Set for Mission Style Cabinet Doors



## 8/900.625



Exclusive CMT design which allows the perfect fit for undersized plywood panel. The tongue cutter features opposing shear angles to obtain flawless finishing on a large variety of materials such as plywood, softwood and hardwood. For use on a table-mounted router, not for handheld routers.

- Adjustable at 0.050mm (0.002") increments;
- For groove width from 5mm (13/64") to 13,5mm (17/32");
- Cut stock thickness of 12,7mm (1/2") to 31,7mm (1-1/4");
- Features micrograin carbide for longer life.

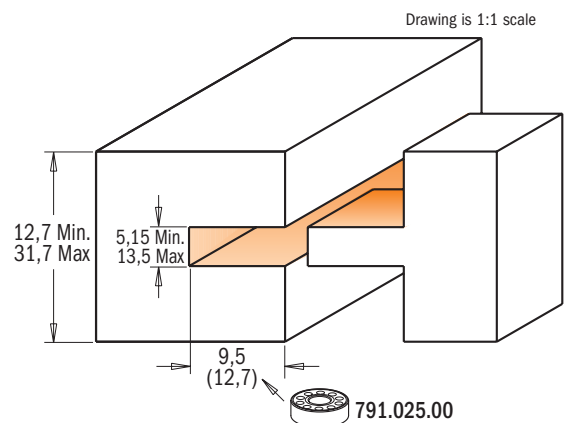
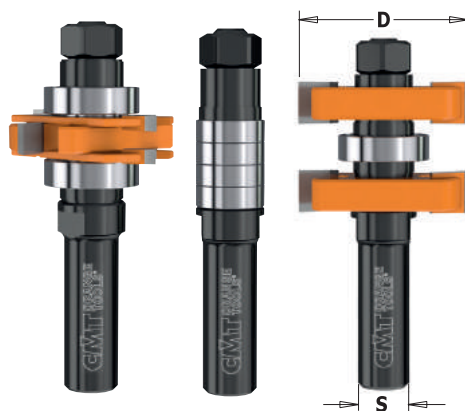

D mm	T <sub>1</sub> mm	Box	ORDER NO. S=Ø12mm	ORDER NO. S=Ø12,7mm
41,2	5,15-13,5	5	<b>900.625.11</b>	
41,2	12,7-31,7	5		<b>800.625.11</b>

Spare parts						
924.136.00	791.012.00	822.025.11	822.026.11	822.027.11	822.028.11	990.020.00
824.136.00	791.012.00	822.025.11	822.026.11	822.027.11	822.028.11	990.020.00

<b>Spare parts</b>	541.515.00	0,1mm spacer	541.518.00	1mm spacer
	541.516.00	0,3mm spacer	541.500.00	3mm spacer
	541.517.00	0,5mm spacer	541.519.00	5,8mm spacer



# Slot Cutter Sets



## 8/923.001

Create slots, grooves and rabbets on all materials using the CMT slot cutter sets. Ideal for biscuit and tongue and groove joints. **These sets include 4 different bearings to allow a cutting depth of 7,95mm, 9,5mm, 12,8mm and 14,3mm.** Please refer to the chart below for applications and the correct cutter combinations.

**SAFETY TIPS:** never use the slot cutter sets without shims between cutters, whose distance can vary from 1mm to 1,7mm. Shims can also be positioned between the ball bearings and the cutters.

### Assembly Illustration

**924.081.10** S=8mm  
**824.121.10** S=12,7mm  
**924.082.10** S=8mm  
**824.122.10** S=12,7mm  
**924.080.10** S=8mm  
**824.127.10** S=12,7mm  
**924.083.10** S=8mm  
**824.128.10** S=12,7mm

Spare parts		
H mm		ORDER NO.
14,3	8-19	791.033.00
12,7	8-22	791.005.00
9,5	8-28,5	791.030.00
8	8-31,5	791.033.00

DESCRIPTION		ORDER NO. S=Ø8mm	Spare parts									
Set	1	<b>923.001.11</b>	822.320.11	823.330.11	823.340.11	823.350.11	822.360.11	924.081.10	924.082.10	924.080.10	924.083.10	

DESCRIPTION		ORDER NO. S=Ø12,7mm	Spare parts									
Set	1	<b>823.001.11</b>	822.316.11	823.332.11	823.340.11	822.348.11	822.364.11	824.121.10	824.122.10	824.127.10	824.128.10	

## 5-Piece Straight Bit Set & Profile Bit Set

Our beautiful sets are the perfect companion for the professional craftsman. We offer three 5-piece sets with a selection of straight bits and the most popular profile router bits. These tools feature Fatigue Proof® steel, micrograin carbide and orange PTFE non-stick coating. Safely stored in a solid plastic box to fit in your display cabinet.



### 8/900.005.01

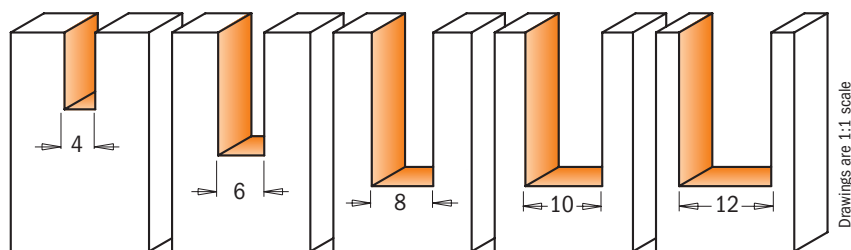

DESCRIPTION		ORDER NO. S=Ø6,35mm	ORDER NO. S=Ø8mm
5-Piece Straight Bit Set	5	<b>800.005.01</b>	<b>900.005.01</b>

### 7/900.005.03

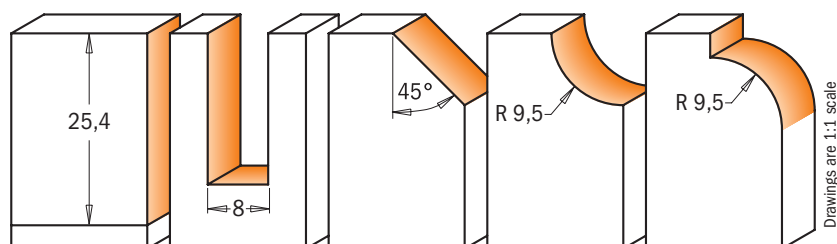

DESCRIPTION		ORDER NO. S=Ø6mm	ORDER NO. S=Ø8mm
5-Piece Profile Bit Set	5	<b>700.005.03</b>	<b>900.005.03</b>

# Router Bit Set with Insert Knives



**600.005.01**



This set is the perfect companion for the professional craftsman. We offer the 5 most popular bits with knives and all necessary spare knives and Torx keys. They are perfect for working on all materials such as solid wood, wood composites, plastic and laminated materials. For use with a hand held or CNC router.

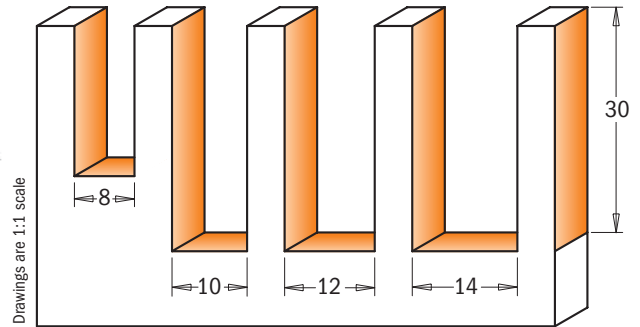

DESCRIPTION	ORDER NO.
Router Bit Set with Insert Knives	600.005.01

10 spare knives and 2 torx keys included

SET CONTAINS	D mm	I mm	KNIVES	ORDER NO. S=Ø8mm
Straight Router Bit with Knife	8	20	790.200.01 - 20 x 4,1 x 1,1mm	651.080.11
Straight Router Bit with Knife	10	30	790.300.01 - 30 x 5,5 x 1,1mm	651.100.11
Straight Router Bit with Knife	12	30	790.300.01 - 30 x 5,5 x 1,1mm	651.120.11
Straight Router Bit with Knife	14	30	790.300.01 - 30 x 5,5 x 1,1mm	651.140.11
Flush Trim Bit with Knife	19	30	790.300.00 - 30 x 12 x 1,5mm	657.191.11

# 5-Piece Spiral Bit Sets

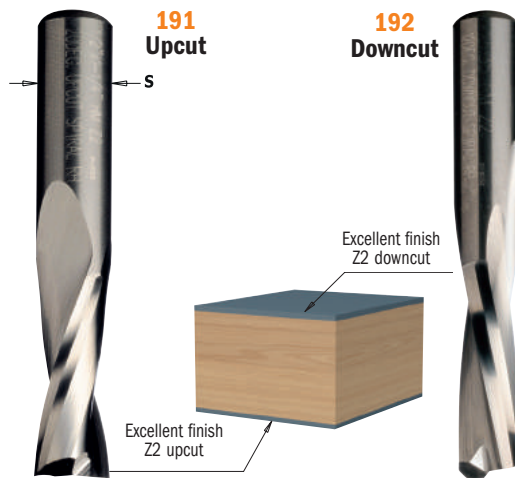

**191/192**



CMT is proud to offer you these new sets of high quality solid tungsten carbide upcut and downcut spiral bits in the most popular diametres. The new formulated super micrograin composition guarantees extremely sharp long-lasting cutting edges, whereas the spiral layout allows for a more efficient chip ejection. In addition, these bits stay cooler during work and are suitable for CMT's new precision machines. Recommended for use on soft and hardwood, plywood, laminates, MDF and plastic materials. To be used on handheld routers and CNC machines.

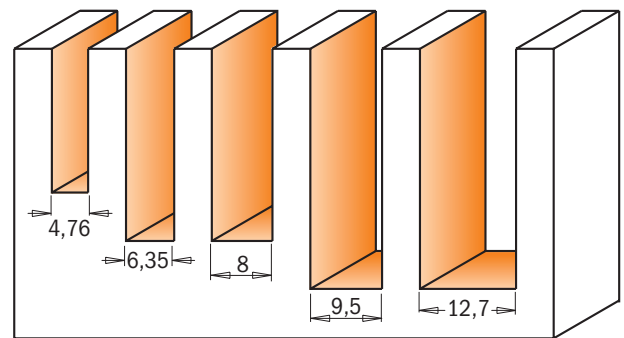
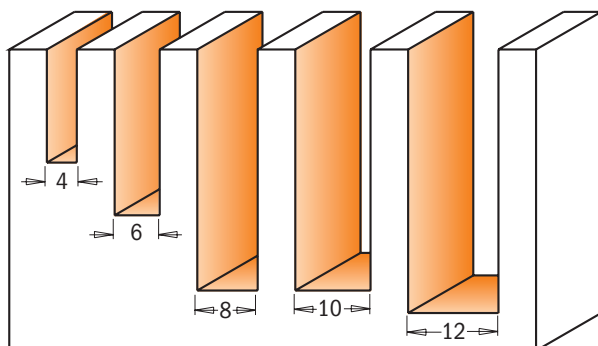

Drawings are 1:1 scale

DESCRIPTION	ORDER NO. S=Ø8mm	ORDER NO. S=Ø6,35-12,7mm
5-Piece Upcut Spiral Bit Sets (Ø4 - 6 - 8 - 10 - 12mm)	191.000.01	
5-Piece Downcut Spiral Bit Sets (Ø4 - 6 - 8 - 10 - 12mm)	192.000.01	
5-Piece Upcut Spiral Bit Sets (Ø4,76 - 6,35 - 8 - 9,5 - 12,7mm)		191.000.02
5-Piece Downcut Spiral Bit Sets (Ø4,76 - 6,35 - 8 - 9,5 - 12,7mm)		192.000.02

# NEW CONTRACTOR ROUTER BIT FROM CMT



Deluxe packaging



For value-driven contractors,  
remodelers and DIYers.  
Great quality/price ratio  
and long-lasting performance.



#### HEAT-TREATED SHANK & BODY FOR GREATER DURABILITY

The bits are made from the finest steel hardened to reach 58 Rockwell which ensures durability and good cutting performance.



#### ANTI-KICKBACK DESIGN

Controls depth of cut and minimizes kickback reducing your risk of injury.



#### SINTERHIP HI-DENSITY CARBIDE

New process called SinterHIP (Hot Isostatic Pressing), helps prevent material failure and increases cutting life.



#### CORROSION-FREE BLACK COATING

Protects against corrosion and provides a longer bit life.

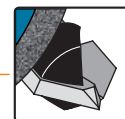

#### PRECISION GROUND CUTTING EDGES

Each cutting edge is precisely sharpened to obtain a sharp and durable cutting angle.







### K911-K912



Designed for making slots and routing channels in wood and wood composites. Hi-Density carbide-tipped cutting edges provide smooth performance and a precise cut. Engineered for efficient chip clearance.



D mm	I mm	L mm	Z		ORDER NO. S=Ø8mm
3	8	51	1	10	<b>K911-030</b>
4	11	51	1	10	<b>K911-040</b>
5	12,7	51	1	10	<b>K911-050</b>
6	16	51	1	10	<b>K911-060</b>
6	25,4	57	2	10	<b>K912-060</b>
8	20	51	2	10	<b>K911-080</b>
8	32	62	2	10	<b>K912-080</b>
10	20	51	2	10	<b>K911-100</b>
10	32	62	2	10	<b>K912-100</b>
12	20	51	2	10	<b>K911-120</b>
12	32	62	2	10	<b>K912-120</b>
14	25,4	56	2	10	<b>K911-140</b>
15	25,4	56	2	10	<b>K911-150</b>
16	25,4	56	2	10	<b>K911-160</b>
18	25	56	2	10	<b>K911-180</b>
20	25	56	2	10	<b>K911-200</b>
22	25,4	56	2	10	<b>K911-220</b>
24	25,4	56	2	10	<b>K911-240</b>
25	25,4	57	2	10	<b>K911-250</b>

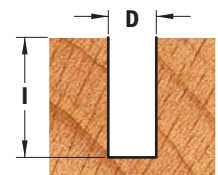

Drawing is 1:1 scale

### Straight Bits with Centre Tip



### K174



Thanks to the center tip the cutting edge allows you to execute any kind of plunge drilling and trimming jobs on soft or hardwood, wood composites and plastic or laminated materials.

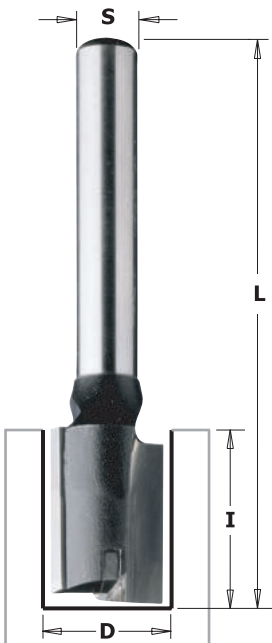

D mm	I mm	L mm	Z		ORDER NO. S=Ø8mm
8	20	51	2+1	10	<b>K174-080</b>
8	40	90	2+1	10	<b>K174-082</b>
10	20	51	2+1	10	<b>K174-100</b>
10	40	90	2+1	10	<b>K174-101</b>
12	20	51	2+1	10	<b>K174-120</b>
12	40	90	2+1	10	<b>K174-121</b>
16	20	51	2+1	10	<b>K174-160</b>
16	40	90	2+1	10	<b>K174-161</b>
18	20	51	2+1	10	<b>K174-180</b>
20	20	51	2+1	10	<b>K174-200</b>
22	20	70	2+1	10	<b>K174-220</b>

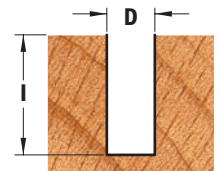

Drawing is 1:1 scale



### K911B

Our pattern bit makes template routing easy and accurate. Create cabinets, furniture, signs, toys or just about any other project you can imagine. Our smooth-running top bearing will glide along your template creating a perfect copy in the wood piece below.



D mm	I mm	L mm	Z		ORDER NO. S=Ø8mm
16	25,4	70	2	10	<b>K911-160B</b>
22	25,4	70	2	10	<b>K911-220B</b>

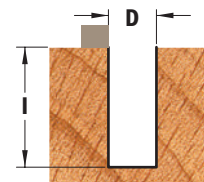

Drawing is 1:1 scale

### Flush Trim Bits



### K906

Precise flush trimming of wood or laminate material. Bottom bearing runs effortlessly against finished work piece delivering a smooth to the touch flush trim cut. Two carbide-tipped cutting edge design optimizes performance.



I mm	D mm	L mm		ORDER NO. S=Ø8mm
14	9,5	56	10	<b>K906-096</b>
25,4	12,7	67	10	<b>K906-127</b>
25,4	19	67	10	<b>K906-191</b>



Drawing is 1:1 scale

### Round Nose Bits



### K914

Designed for sign and cabinet makers. Use the round nose to make decorative doors, drawer fronts, signs or add a design to any other creative project. Features two carbide-tipped cutting edges which, provide a smooth cut in wood and wood products.

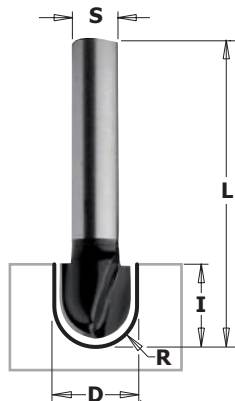

R mm	D mm	I mm	L mm		ORDER NO. S=Ø8mm
3	6	9,5	40	10	<b>K914-060</b>
4,75	9,5	9,5	40	10	<b>K914-095</b>
6,35	12,7	12,7	40	10	<b>K914-127</b>
8	16	12,7	45	10	<b>K914-160</b>
9,5	19	12,7	46	10	<b>K914-190</b>

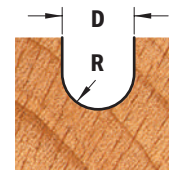

Drawing is 1:1 scale

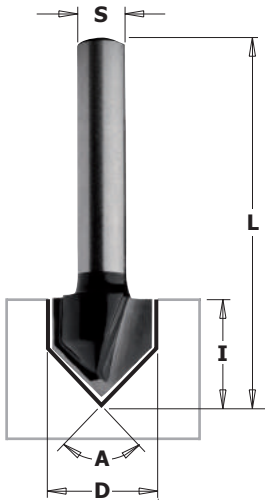

### K915-K958



Make a clean sharp v-groove in panel and drawer fronts for decorative projects. Good for engraving letters for signs, they feature two sharp carbide-tipped cutting edges for smooth fast cutting. Choose from our 60° or 90° v-groove angle.

D mm	I mm	A	L mm	Z		ORDER NO. S=Ø8mm
12,7	12,7	90°	45	2	10	<b>K915-127</b>
16	16	90°	45	2	10	<b>K915-160</b>
31,8	20	90°	60	2	10	<b>K915-317</b>
11	14	60°	45	2	10	<b>K958-110</b>

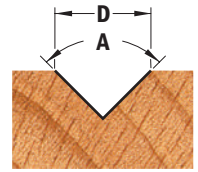

Drawing is 1:1 scale

### Decorative Ogee Bit

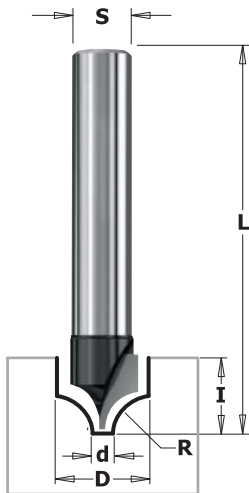

### K965



This new CMT bit produces a classic single or double-edged bead. Ideal for creating a marked decorative effect on panel, door and drawer work.

D mm	d mm	I mm	R mm	L mm		ORDER NO. S=Ø8mm
10	1,3	10	5	50,8	10	<b>K965-100</b>

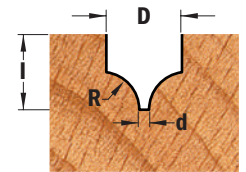

Drawing is 1:1 scale

### Keyhole Bit

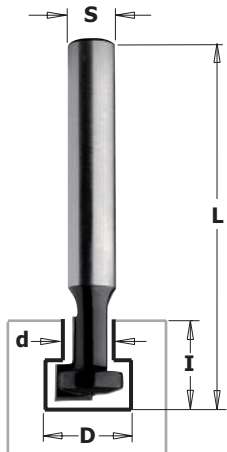

### K950



Easily create a hardware-free way to hang pictures and plaques on a wall. Cuts a key-holed groove or slot in a variety of materials such as wood, plywood and laminates.

D mm	d mm	I mm	L mm		ORDER NO. S=Ø8mm
9,5	4,76	11,1	48	10	<b>K950-095</b>

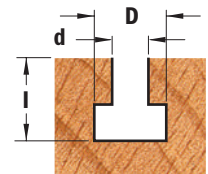

Drawing is 1:1 scale



# Dovetail Bit

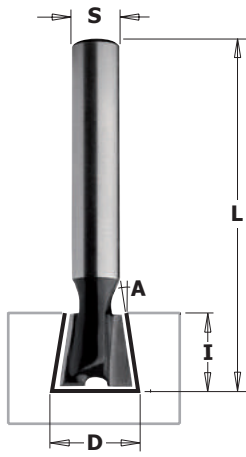

## K918

Use our bits with some of the most popular dovetail jigs on the market to create clean dovetail joints in wood and wood composite material. Balanced for good performance.



D mm	I mm	L mm	A	Box	ORDER NO. S=∅8mm
12,7	12	45	14°	10	K918-127

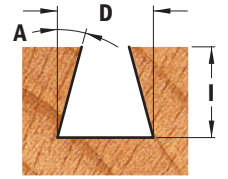

# Slot Cutters

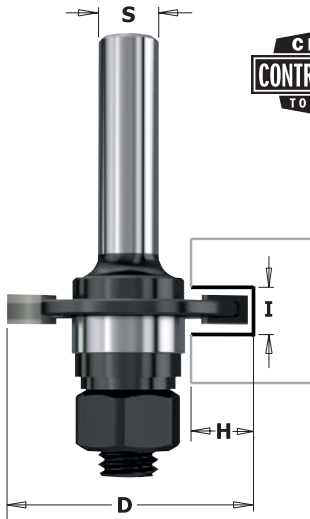

## K922

Uses for these 2 wing slot cutter are almost infinite. Cut slots and grooves for splines, biscuits, T-molding or tongue and groove joints.



**NOTE:** For biscuit joints, use I=4mm slot cutter.

I mm	D mm	H mm	Box	ORDER NO. S=∅8mm
3	40	12,5	10	K922-330A
4	40	12,5	10	K922-340A
5	40	12,5	10	K922-350A
6	40	12,5	10	K922-360A

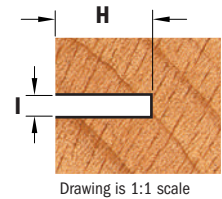

# Chamfer Bit

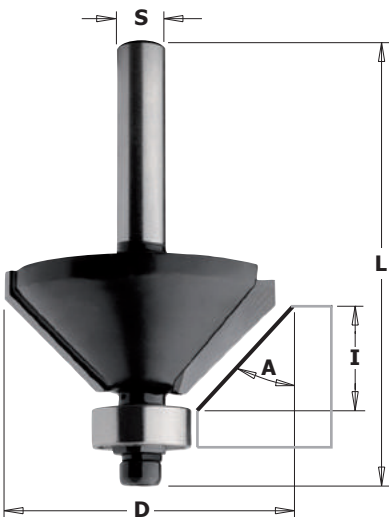

## K936

Produce clean, accurate bevel or chamfer edges for edge jointing, decorative edges or perfectly aligned boxes. Features two carbide-tipped cutting edges, anti-kickback design with heat treated shank and body for durability. Bottom bearing included.



D mm	I mm	A	L mm	Box	ORDER NO. S=∅8mm
35	15	45°	56	10	K936-350

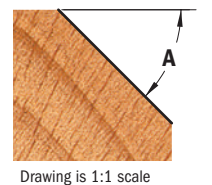

# Rabbeting Bit

new

**CMT ORANGE TOOLS®**

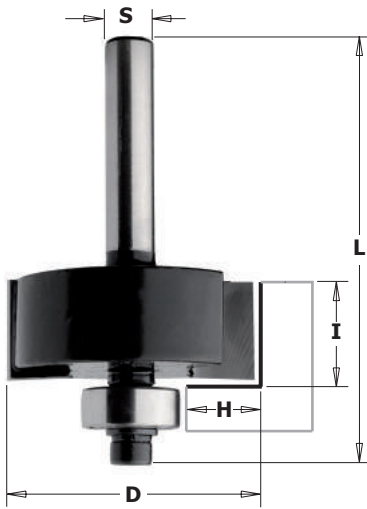

## K935

Ideal for creating inset doors and drawer fronts or to re-groove old window frames to accept a panel of glass. Features two carbide-tipped cutting edges, anti-kickback design with heat treated shank and body for durability. Bottom bearing included.



D mm	I mm	H mm	L mm		ORDER NO. S=Ø8mm
31,8	12,7	9,5	54	10	<b>K935-317</b>

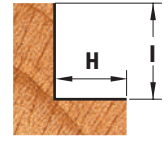

Drawing is 1:1 scale

# Cove Bits

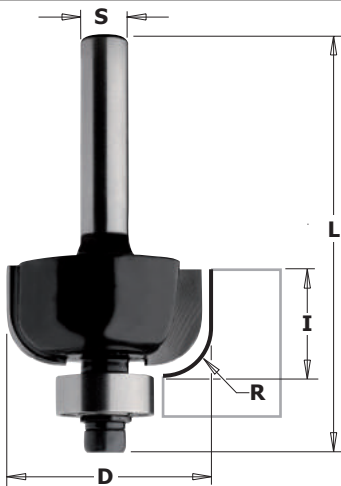

## K937

Give your doors and drawer fronts an elegant touch. Pair a cove bit with a roundover bit to create decorative elements on your furniture projects. Features two carbide-tipped cutting edges, anti-kickback design, heat treated shank and body for durability. Bottom bearing included.



D mm	I mm	R mm	L mm		ORDER NO. S=Ø8mm
31,8	14	9,5	56	10	<b>K937-317</b>
38,1	16	12,7	62	10	<b>K937-380</b>

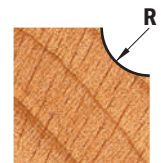

Drawing is 1:1 scale

# Ovolo Bit



## K927

Ideal for furniture makers, you get a roundover with top and bottom bead all in one. Bit equipped with two carbide-tipped cutting edges, features anti-kickback design and heat treated shank and body for increased durability.



D mm	I mm	R mm	L mm		ORDER NO. S=Ø8mm
25,4	14,3	6,3	46	10	<b>K927-064</b>



Drawing is 1:1 scale

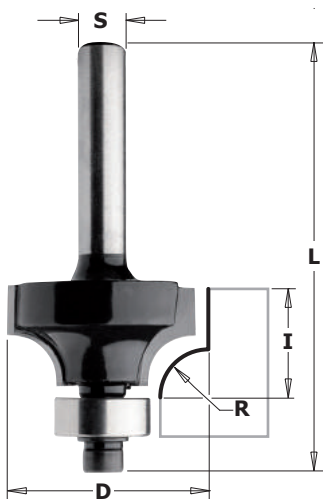

**K938**

A popular profile for taking the edge off a sharp corners. When partnered with a cove bit, you can create a drop-leaf table or other intricate projects. Bits equipped with two carbide-tipped cutting edges, anti-kickback design, and heat treated shank/body for increased durability. Bottom bearing included.



D mm	I mm	R mm	L mm		ORDER NO. S=Ø8mm
16,7	7,9	2	51	10	<b>K938-167</b>
18,7	10,5	3	53	10	<b>K938-187</b>
22,2	12,7	4,8	54	10	<b>K938-222</b>
25,4	13,5	6,3	55	10	<b>K938-254</b>
28,7	15,5	8	53	10	<b>K938-287</b>
31,8	16,5	9,5	58	10	<b>K938-317</b>
38,1	19	12,7	61	10	<b>K938-380</b>
44,7	22,2	16	67	10	<b>K938-445</b>

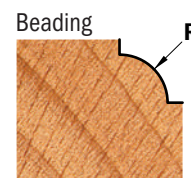
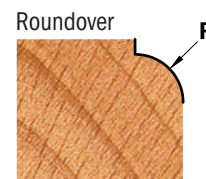

EACH BIT INCLUDES A 3/8" BEARING FOR BEADING PROFILES

Drawing is 1:1 scale

Roman Ogee Bit

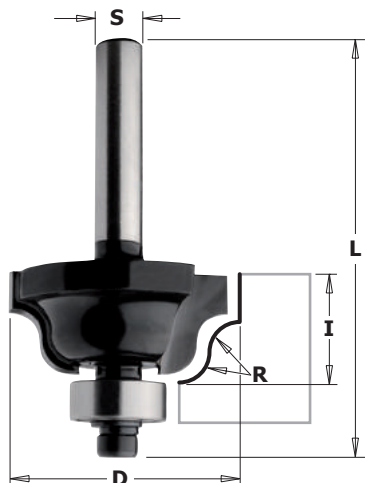

**K940**

A very popular bit for making a wavy profile which, gives a touch of class to your furniture. These bits feature an anti-kickback design, rust-resistant black coating and include a smooth running bearing for template work.



D mm	I mm	R mm	L mm		ORDER NO. S=Ø8mm
28,6	12,7	4	54	10	<b>K940-286</b>



Drawing is 1:1 scale

Classical Ogee Bits

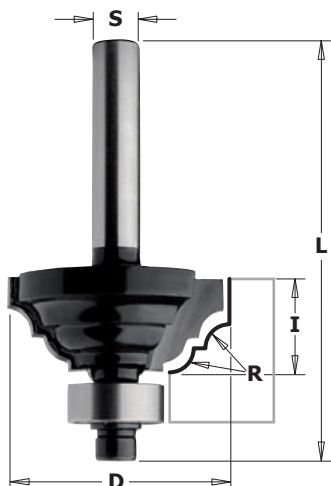

**K941**

This bit produces both a concave and a convex profile on your work piece for smooth eye-catching detail! They feature 2 sharp cutting edges, rust-resistant black coating and are equipped with a bottom bearing for easy template work on both natural wood and wood-based materials.



D mm	I mm	R mm	L mm		ORDER NO. S=Ø8mm
42,9	18	6,3	60	10	<b>K941-430</b>



Drawing is 1:1 scale



# Finger Pull Bit

new

**CMT ORANGE TOOLS®**

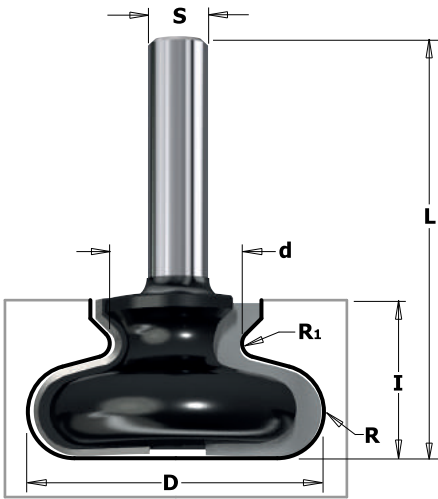

## K955



Why interrupt the subtle linearity of an all-wood drawer front or cabinet door with a metal knob or handle? Use these finger pull bits and make a harmonious wooden handle. Two options are available: a template profile made directly in the wood or a European-style hardwood pull as illustrated below.

D mm	d mm	I mm	R mm	R <sub>1</sub> mm	L mm		ORDER NO. S=∅8mm
19,05	9,5	19,05	4,8	2,4	57,2	10	<b>K955-190</b>
38,1	17	20,7	6	1,8	55,4	10	<b>K955-380</b>

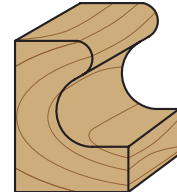
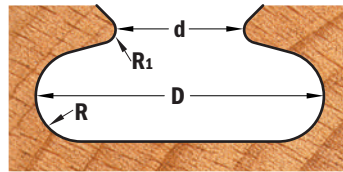

Drawing is 1:1 scale

# Replacement Bearing Set



## 79101

PACK QTY. 10

SET INCLUDES	PIECES
3/8" Bearing	1
1/2" Bearing	1
3/8" Dust Shields	1
1/2" Dust Shields	1
Screw	1
Hex Key	1

# What work parameters are best when routing?

Answering the following questions will provide you with the answer!

- **What equipment are you using?** Using brand new equipment of high quality is not the same as using outdated machinery! It is important to understand that vibration is the direct result of wear and tear, which can lead to a poor quality finish. Feed rate should be chosen in order to dampen vibration, and quite often, higher feed rates are associated with better finishing results.
- **What factors influence the performance of the bit I am using?** Many factors affect performance and the ultimate finish of the workpiece: the power of the collet chuck, the rigidity and eccentricity of the couplings, conditions and quality of the collets, reverse locking system, sharpened tool edge, the dust-collection system in use and even the relative humidity of the workplace environment.
- **What bit should I use?** The number of cutting edges as well as the cutting diameter significantly affect work parameters. In general, the more cutting edges and the wider the blade diameter, the higher the feed rate.
- **What is the cutting depth I hope to carry out?** In order to increase cutting depth, it is necessary to reduce the feed rate and vice versa for shallower cuts.
- **At what speed does my machine run?** By increasing the spindle speed (rpm), the quality of the finished edge improves. However, at the same time friction also increases between the tool and the workpiece. As a result, tool longevity is compromised. Ideally, the objective is to select the slowest rotation speed possible compatible with the quality of finishing you hope to achieve.
- **What edge finish am I looking to achieve?** Coarse routing and fine routing are definitely not the same thing! You need to figure out what is more important: quality or quantity. In order to prolong the life of your cutting tool, its best to choose the highest feed rate possible best suited to achieve the finish you want.
- **Above all...what materials am I working with?** Wood is a good example of natural fiber composite. It is made up of a natural fibrous material, both elastic and flexible (cellulose: long molecular polymer chains), bound together by a very rigid substance (lignin: cross-linked polymer) as well as a compatibilizer (hemicellulose: a polysaccharide). It is an anisotropic material, that is, directionally dependent, changing with direction along the object. How many types of wood and wood derivatives are you familiar with? Remember, no two pieces of wood are the same! In fact, the same work parameters carried out on two different pieces of wood will provide two very different results.

Feed rate is dependent of several factors, like the ones mentioned above - and these are just a few examples. It is important to weigh all factors in order to select an optimum feed rate suitable for the tools and work objectives involved. CMT is synonymous with quality and to produce high quality cuts you just can't randomly shoot off a bunch of numbers. Be wary of those who provide you with random numbers.

**I get it....but where do I start?** The best way to go forward is step-by-step using reliable test data. To quickly achieve the results best suited for your specific work expectations, you can always turn to theory!

One rule of thumb, which may prove advantageous, is to use a simple gauge to measure chipload wherever possible. On the one hand, it should be noted that when chips that are too thick, breakage will occur, resulting in a poor, rough finish. On the other hand, when chips are too thin, it will negatively affect tool longevity and cause rapid wear and tear of the cutting edge because the teeth of the tool are rubbing more than removing material.

The next time you experiment, you need to properly assess the specific demands of the work involved, assess chipload measurements and try to orient yourself towards a different thickness by taking into account the aforementioned factors. Then, with the aid of the formulas listed below, proceed to establish the appropriate feed rate for your next test. This will help you to achieve better results faster and you will have the essential information you will need for the next work project.

**PARAMETERS:**

**V = feed rate (m/min)**

**Z = cutting edges**

**C = Chipload (mm)**

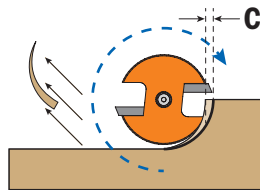

**EXAMPLE:**

**with caliper take measurement of a good result chipload (C=0,2mm).**

**Z=2**

**RPM=18000**

**V = (RPM x Z x C)/1000 = (18000x2x0,2)/1000 = 7,2m/min**

**FORMULAS:**

**V = (RPM x Z x C)/1000**

**RPM = V x 1000 / (Z x C)**

## PROBLEM SOLVING

### PROBLEM

Bad finishing
Cutting edge wear
Cutting edge burns
Cutting edge debris
Vibrations
Cutter breakage

### SOLUTIONS

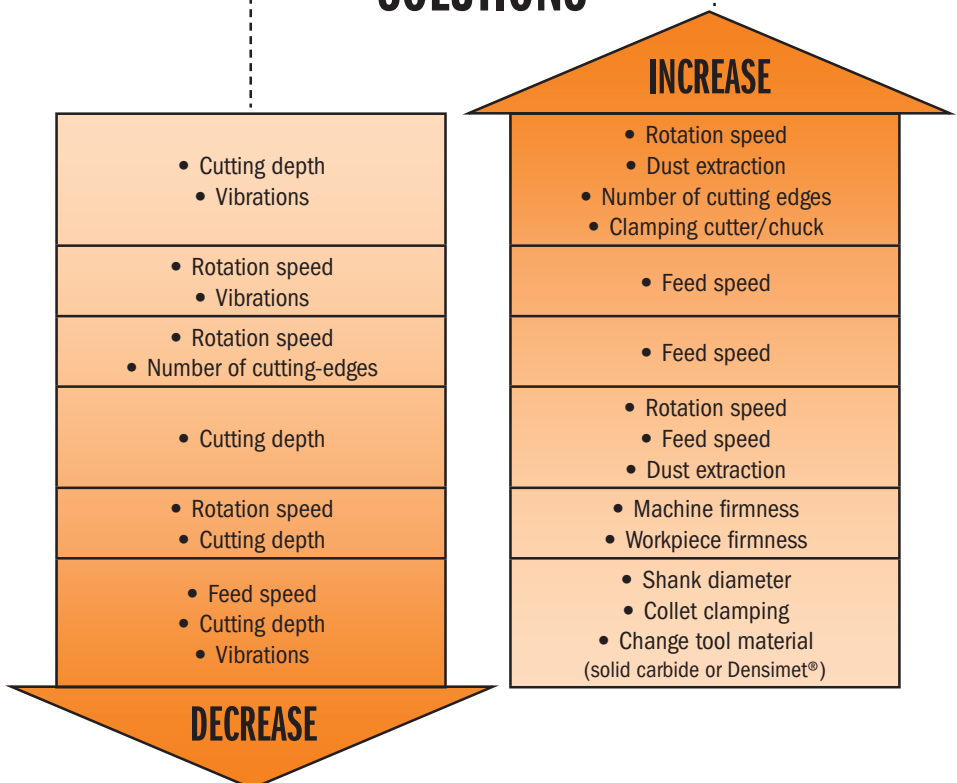

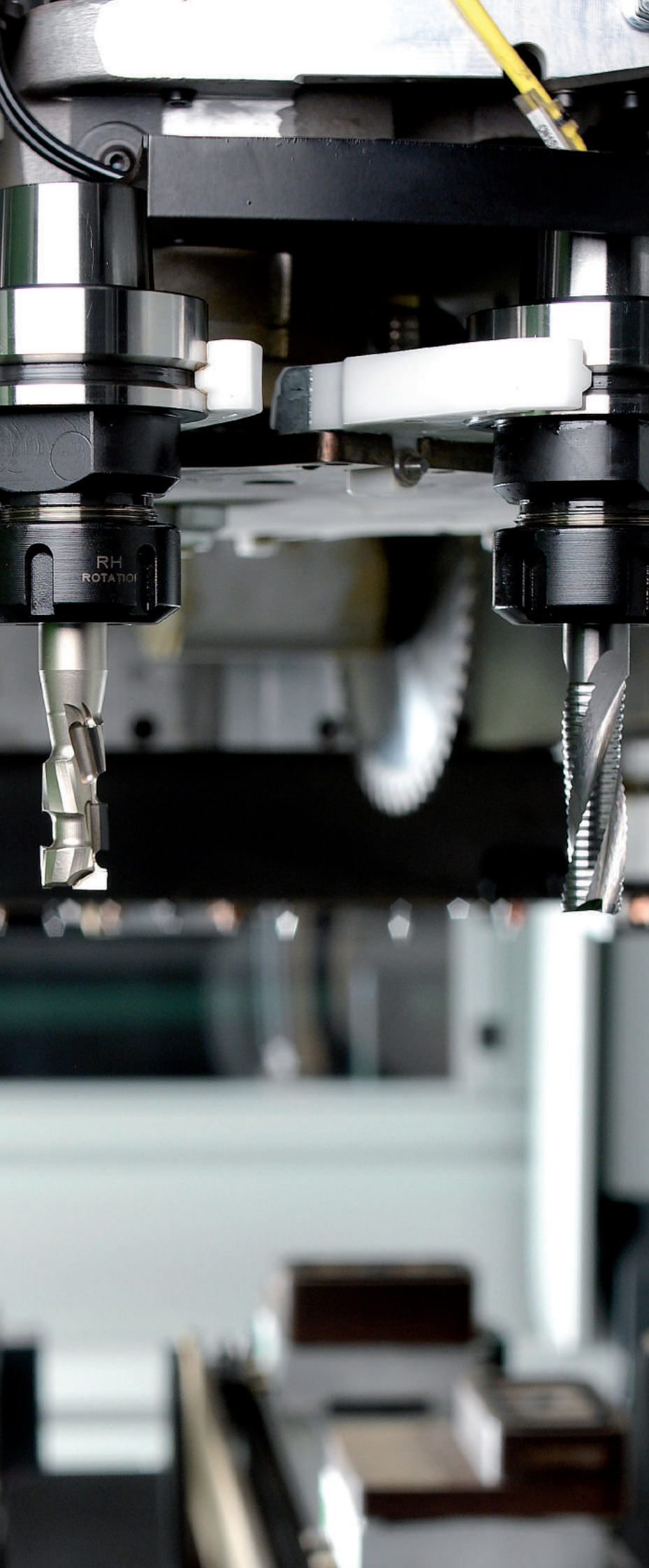

# CNC ROUTER CUTTERS & CHUCKS

PRODUCTS	PAGE
Kinetic Dust Extractor	248
CNC Chucks	249~252
Precision Collets	252-253
MK2 Chucks	254
HSK Chucks for Grooving Blade	254-255
Cutter Arbor	256
Universal Assembly Supports for Chucks	256
DLCs Coating Solid Carbide Spiral Bits	257
Solid Carbide Spiral Bits	258-268
Solid Surface and Fiberglass Bits	269
CNC DP Straight Cutters	270-274
CNC Carbide Cutters	275~278
CNC Profiled Cutters	279-283
Slot & Mortise Bits	284~290





# Kinetic Dust Extractor



## 992 Removes MDF & Chipboard dust from the workpiece

DESCRIPTION	D mm		ORDER NO.
<b>new</b> Kinetic Dust Extractor for chucks with ER20	80	1	<b>992.081.ER20</b>
<b>new</b> Kinetic Dust Extractor for chucks with ER25	80	1	<b>992.081.ER25</b>
Kinetic Dust Extractor for chucks with DIN6388/EOC25 collets	100	1	<b>992.101.EOC25</b>
Kinetic Dust Extractor for chucks with ER32 collets	100	1	<b>992.101.ER32</b>
Kinetic Dust Extractor for chucks with ER40 collets	100	1	<b>992.101.ER40</b>

**Spare parts** 991.285.00 C-Spanner 80-90mm (ER20/ER25)  
 991.284.00 C-Spanner 95-100mm (EOC25/ER32/ER40)

**Optional**  
 (required for installation, not included)

### EASY TO USE!

#### Install & remove as a clamping nut

- Health & Safety
- Tool Performance & Cut Quality
- Tool Life & Labor Costs
- Recommended for Nesting and Routing operations
- No wasted time during work process
- Replaces the standard clamping nut
- Suitable for any collet chucks with standard router bits
- Available for ER32 - ER40 - EOC25 (DIN6388) collets
- The thick ceramic coat gives to KDE an anti-corrosion, anti-friction and anti-static surface.
- Tool body in light alloy
- Better air quality
- Good performances even at low rpm: from 6,000 up to 20,000 rpm
- Material: chipboard, coated chipboard, MDF, Corian®, plasterboard, OSB, HPL.

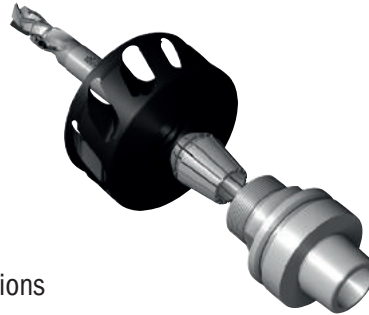

Always use vacuum system.

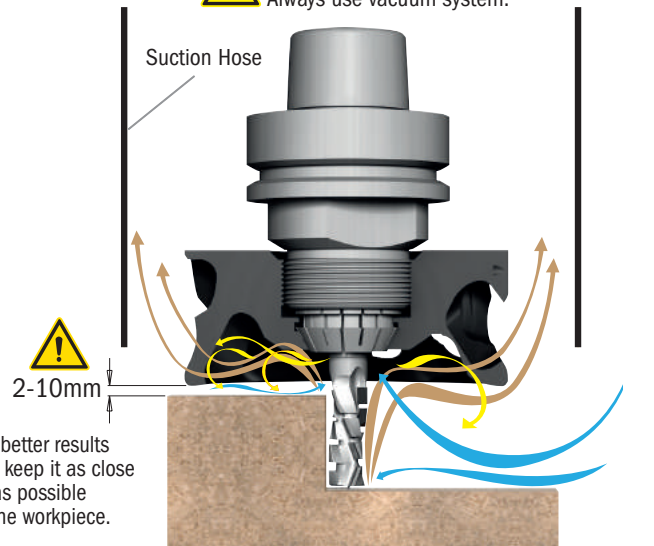

Compressed Air Dust Air Vacumed



Download Instruction

Watch the video on



Watch Video

### Working **WITHOUT** Kinetic Dust Extractor



### Working **WITH** Kinetic Dust Extractor

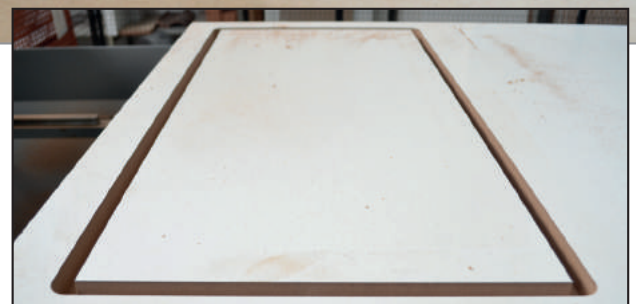

# HSK Chucks for "ER40" Precision Collets

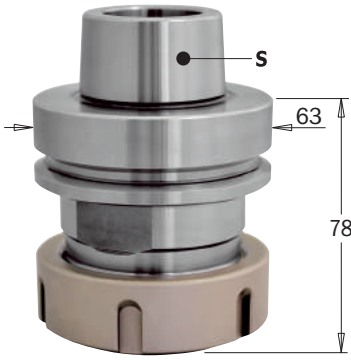

## 183.310 XTREME



S	DESCRIPTION	TO BE USED WITH COLLET	ORDER NO. Left-hand rotation	ORDER NO. Left-hand rotation
HSK-63F	Clamping nut without bearing	ER40	1	<b>183.310.01</b>
HSK-63F	Clamping nut with bearing	ER40	1	<b>183.310.11*</b>
<i>Spare parts</i> 990.117.00 M6x6mm screw			* Suitable for right-hand and left-hand rotation.	



### Non-STICK ORANGE CHROME® SHIELD COATING

- prevents overheating
- protects against corrosion and rust
- reduces resin build-up
- longer life and greater tool performance

For Homag, Eima, IMA from 9/94, Dubus, Weeke, Biesse, SCM, Morbidelli and Masterwood machines.

S	DESCRIPTION	TO BE USED WITH COLLET	ORDER NO. Right-hand rotation	ORDER NO. Right-hand rotation
<b>new</b> HSK-63F	Clamping nut without bearing	ER40	1	<b>183.310.91</b>
<i>Spare parts</i> 990.117.00 M6x6mm screw			Without Orange Chrome® Shield Coating	

# ISO30 Chucks for "ER40" Precision Collets

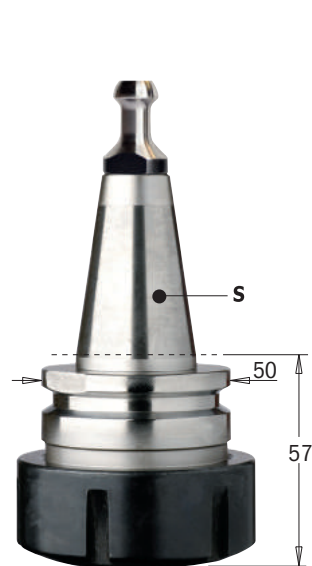

995.200

## 183.201



S	TO BE USED WITH COLLET	RETAINING STUD mm	ORDER NO. Right-hand rotation
ISO30	ER40	Ø12-8	1 <b>183.201.01</b>

For Biesse machines



995.201

## 183.211



S	TO BE USED WITH COLLET	RETAINING STUD mm	ORDER NO. Right-hand rotation
ISO30	ER40	Ø13-9	1 <b>183.211.01</b>

For Biesse machines with Omlat engine, Bulleri, Busellato, CMS and IMA machines.



995.202

## 183.221



S	TO BE USED WITH COLLET	RETAINING STUD mm	ORDER NO. Right-hand rotation
ISO30	ER40	Ø12,8-9	1 <b>183.221.01</b>

For Alberti and Masterwood machines.

# Clamping Nuts for Chucks with "ER40" Precision Collets



## 992.383



DESCRIPTION	ORDER NO. Right-hand rotation	ORDER NO. Left-hand rotation
<b>Clamping nut without bearing</b>		
For 183.201/211/221/310 chucks	1 <b>992.383.01</b>	<b>992.383.02</b>
<b>Clamping nut with bearing</b>		
For 183.201/211/221/310 chucks	1 <b>992.383.11</b>	

# C-spanner for "ER40" Precision Collets



## 991.184

DESCRIPTION	ORDER NO.
C-Spanner for "ER40" precision collet	1 <b>991.184.00</b>

# HSK Chuck for "ER32" Precision Collets

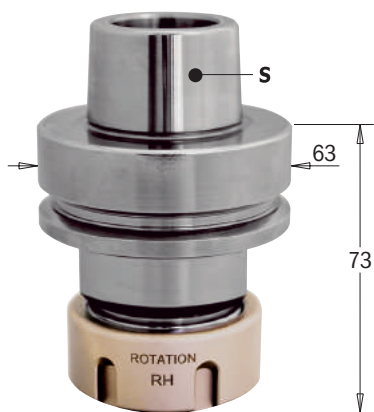

## 183.300 X-TREME

S	DESCRIPTION	TO BE USED WITH COLLET	BOX	ORDER NO. Right-hand rotation	ORDER NO. Left-hand rotation
HSK-63F	Clamping nut without bearing	ER32	1	183.300.01	183.300.02
HSK-63F	Clamping nut with bearing	ER32	1	183.300.11*	

Spare parts 990.118.00 M6x10mm screw

\* Suitable for right-hand and left-hand rotation.



### Non-Stick Orange Chrome® Shield Coating

- prevents overheating
- protects against corrosion and rust
- reduces resin build-up
- longer life and greater tool performance

For Homag, Eima from 9/94, Dubus, Weeke, Biesse, SCM, Morbidelli and Masterwood machines.

S	DESCRIPTION	TO BE USED WITH COLLET	BOX	ORDER NO. Right-hand rotation	ORDER NO. Left-hand rotation
<b>new</b> HSK-63F	Clamping nut without bearing	ER32	1	183.300.91	

Spare parts 990.118.00 M6x10mm screw

Without Orange Chrome® Shield Coating

# ISO30 Chucks for "ER32" Precision Collets



## 183.200



S	TO BE USED WITH COLLET	RETAINING STUD mm	BOX	ORDER NO. Right-hand rotation	ORDER NO. Left-hand rotation
ISO30	ER32	Ø12-8	1	183.200.01	183.200.02

For Biesse machines.

## 183.210



S	TO BE USED WITH COLLET	RETAINING STUD mm	BOX	ORDER NO. Right-hand rotation	ORDER NO. Left-hand rotation
ISO30	ER32	Ø13-9	1	183.210.01	183.210.02

For Biesse machines with Omlat engine, Bulleri, Busellato, CMS and IMA machines.

## 183.220



S	TO BE USED WITH COLLET	RETAINING STUD mm	BOX	ORDER NO. Right-hand rotation	ORDER NO. Left-hand rotation
ISO30	ER32	Ø12,8-9	1	183.220.01	183.220.02

For Alberti and Masterwood machines.

# ISO30 Chucks for "ER32" Precision Collets

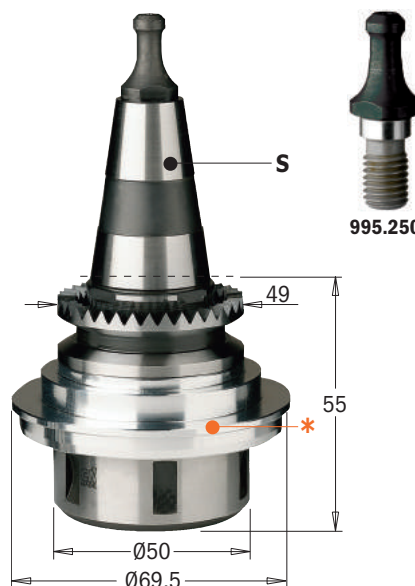

## 183.250 without aluminium flange



S	TO BE USED WITH COLLET	RETAINING STUD mm	BOX	ORDER NO. Right-hand rotation	ORDER NO. Left-hand rotation
ISO30	ER32	Ø8,5	1	183.250.01	183.250.02

For Morbidelli and SCM machines.

## 183.251 with Ø69,5mm aluminium flange fully assembled (\*)



S	TO BE USED WITH COLLET	RETAINING STUD mm	BOX	ORDER NO. Right-hand rotation	ORDER NO. Left-hand rotation
ISO30	ER32	Ø8,5	1	183.251.01	183.251.02

Spare parts 992.501.00 Ø69,5mm aluminium flange\*

For Morbidelli and SCM machines.



## Chucks for "ER32" Precision Collets

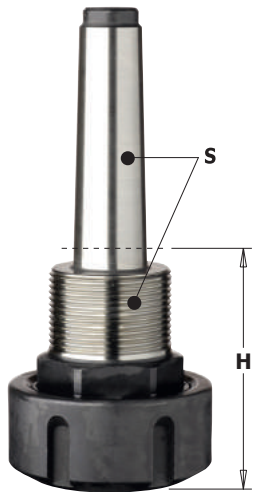

**183.000/100**

**RH LH**

S mm	TO BE USED WITH COLLET	H mm		ORDER NO. Right-hand rotation	ORDER NO. Left-hand rotation
MK2/M30x1,5	ER32	62	1	<b>183.000.01</b>	<b>183.000.02</b>
MK3/M30x1,5	ER32	70	1	<b>183.100.01</b>	

**MK2/MK3 tapered shank**

## Chucks for "ER32" Precision Collets

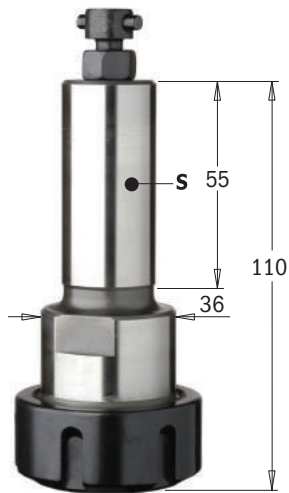

995.400

**183.400**

**RH**

S mm	TO BE USED WITH COLLET	RETAINING STUD		ORDER NO. Right-hand rotation
Ø25x55	ER32	PS LEUCO	1	<b>183.400.01</b>

**For machines with PS Leuco system.**

## Clamping Nuts for Chucks with "ER32" Collets



**992.183**

**RH LH**

DESCRIPTION		ORDER NO. Right-hand rotation	ORDER NO. Left-hand rotation
<b>Clamping nut without bearing</b> For 183.000/100/200/250/300/400 chucks	1	<b>992.183.01</b>	<b>992.183.02</b>
<b>Clamping nut with bearing</b> For 183.000/100/200/250/300/400 chucks	1	<b>992.183.11</b>	<b>992.183.12</b>

## C-Spanner for "ER32" Precision Collets



**991.183**

DESCRIPTION		ORDER NO.
C-Spanner for "ER32" precision collets	1	<b>991.183.00</b>

# HSK Chuck for "DIN6388" - EOC25 Precision Collet

RH

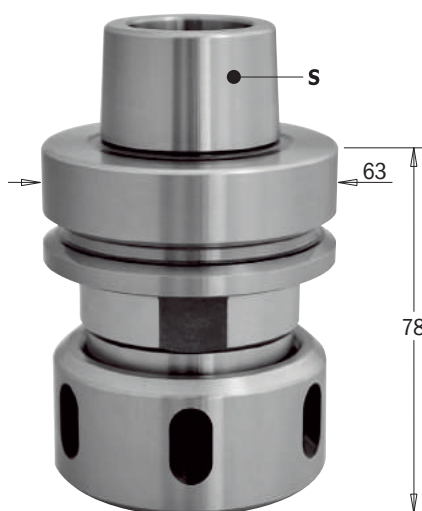

## 183.320

S	DESCRIPTION	TO BE USED WITH COLLET		ORDER NO. Right-hand rotation
HSK-63F	HSK chuck with bearing nut	EOC-25	1	<b>183.320.01*</b>
HSK-63F	HSK chuck without bearing nut	EOC-25	1	<b>183.320.03</b>

**Spare parts** 992.283.11 Clamping nut with bearing  
992.283.01 Clamping nut without bearing

\* Suitable for left-hand rotation too.

For Homag, Eima from 9/94, Dubus, Weeke, Biesse, SCM, Morbidelli & Masterwood machines.

## Clamping Nuts



## 992.283

DESCRIPTION		ORDER NO. Right-hand rotation
Clamping nut without bearing	1	<b>992.283.01</b>
Clamping nut with bearing	1	<b>992.283.11</b>

For chuck 183.320.

## C-Spanner for "DIN6388" & "ER40"



## 991.283

DESCRIPTION		ORDER NO.
C-Spanner for 58-62-65	1	<b>991.283.00</b>

## Precision Collets "DIN6388"



## 185 - EOC-25

mm	B inches		ORDER NO.	mm	B inches		ORDER NO.
3		10	<b>185.030.00</b>	12		10	<b>185.120.00</b>
4		10	<b>185.040.00</b>	12,7	1/2	10	<b>185.127.00</b>
5		10	<b>185.050.00</b>	14		10	<b>185.140.00</b>
6		10	<b>185.060.00</b>	16	5/8	10	<b>185.160.00</b>
6,35	1/4	10	<b>185.064.00</b>	18		10	<b>185.180.00</b>
8	5/16	10	<b>185.080.00</b>	19,05	3/4	10	<b>185.191.00</b>
9,5	3/8	10	<b>185.095.00</b>	20		10	<b>185.200.00</b>
10		10	<b>185.100.00</b>	25		10	<b>185.250.00</b>

REMARK: special dimensions available on request.



## 185 - EOC-16

mm	B inches		ORDER NO.	mm	B inches		ORDER NO.
6		10	<b>185.060.16</b>	12		10	<b>185.120.16</b>
8	5/16	10	<b>185.080.16</b>	14		10	<b>185.140.16</b>
10		10	<b>185.100.16</b>	16	5/8	10	<b>185.160.16</b>

REMARK: special dimensions available on request.

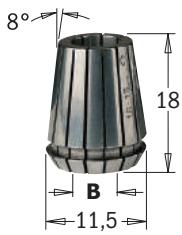

## 184 - ER11

B mm		ORDER NO.
2	10	184.020.11
3	10	184.030.11
4	10	184.040.11
5	10	184.050.11
6	10	184.060.11

**TECHNICAL DETAILS:**

- replaceable Std "ER11" collets (from 1 to 7mm)
- fit most tapered spindle noses
- +0-0,7mm wide clamping tolerance
- suitable for most conical chucks.

**REMARK:** special dimensions available on request.

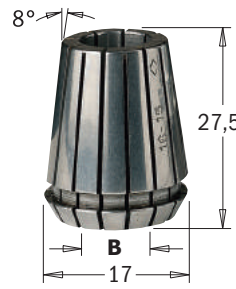

## 184 - ER16

B mm		ORDER NO.
2	10	184.020.16
3	10	184.030.16
4	10	184.040.16
5	10	184.050.16
6	10	184.060.16
7	10	184.070.16
8	10	184.080.16
9	10	184.090.16
10	10	184.100.16

**TECHNICAL DETAILS:**

- replaceable Std "ER16" collets (from 1 to 10mm)
- fit most tapered spindle noses
- +0-0,7mm wide clamping tolerance
- suitable for most conical chucks.

**REMARK:** special dimensions available on request.

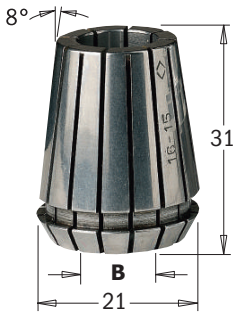

## 184 - ER20

B mm		ORDER NO.
2	10	184.020.20
3	10	184.030.20
4	10	184.040.20
5	10	184.050.20
6	10	184.060.20
6,35	10	184.064.20
7	10	184.070.20
8	10	184.080.20
9	10	184.090.20
10	10	184.100.20
11	10	184.110.20
12	10	184.120.20
12,7	10	184.127.20

**TECHNICAL DETAILS:**

- replaceable Std "ER20" collets (from 1 to 13mm)
- fit most tapered spindle noses
- +0-0,7mm wide clamping tolerance
- suitable for most conical chucks.

**REMARK:** special dimensions available on request.



## 184 - ER25

B mm		ORDER NO.
3	10	184.030.25
4	10	184.040.25
5	10	184.050.25
6	10	184.060.25
6,35	10	184.064.25
8	10	184.080.25
9	10	184.090.25
10	10	184.100.25
12	10	184.120.25
12,7	10	184.127.25
14	10	184.140.25
16	10	184.160.25

**TECHNICAL DETAILS:**

- replaceable Std "ER25" collets (from 1 to 16mm)
- fit most tapered spindle noses
- +0-0,7mm wide clamping tolerance
- suitable for most conical chucks.

**REMARK:** special dimensions available on request.



## 184 - ER32

B mm		ORDER NO.
3	10	184.030.00
4	10	184.040.00
5	10	184.050.00
6	10	184.060.00
6,35	10	184.065.00
7	10	184.070.00
8	10	184.080.00
9	10	184.090.00
9,52	10	184.095.00
10	10	184.100.00
11	10	184.110.00
12	10	184.120.00
12,7	10	184.127.00
14	10	184.140.00
15	10	184.150.00
16	10	184.160.00
17	10	184.170.00
18	10	184.180.00
19	10	184.190.00
20	10	184.200.00

**For chucks**  
183.000/100/200/250/300/400

**TECHNICAL DETAILS:**

- replaceable Std "ER32" collets (from 3 to 20mm)
- fit most tapered spindle noses
- +0-0,7mm wide clamping tolerance
- suitable for most conical chucks.

**REMARK:** special dimensions available on request.



## 184 - ER40

B mm		ORDER NO.
3	10	184.032.00
4	10	184.042.00
5	10	184.052.00
6	10	184.062.00
6,35	10	184.064.00
7	10	184.072.00
8	10	184.082.00
9,52	10	184.096.00
10	10	184.102.00
12	10	184.122.00
12,7	10	184.128.00
14	10	184.142.00
16	10	184.162.00
18	10	184.182.00
19	10	184.192.00
20	10	184.202.00
25	10	184.252.00

**For chucks**  
183.201/211/221/310

**TECHNICAL DETAILS:**

- replaceable Std "ER40" collets (from 3 to 25mm)
- fit most tapered spindle noses
- +0-0,7mm wide clamping tolerance
- suitable for most conical chucks.

**REMARK:** special dimensions available on request.



## Cap Nuts for CNC Machines



### 993.0

**RH LH**

INTERNAL THREAD			ORDER NO. Right-hand rotation	ORDER NO. Left-hand rotation
Ø20x14F1"		1	<b>993.020.01</b>	<b>993.020.02</b>
M30x1,5		1		<b>993.030.02</b>

For machines with M33x3 threaded spindle nose.

## ISO30 Retaining Studs

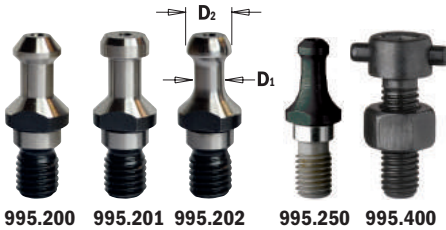

DESCRIPTION	D <sub>1</sub> mm	D <sub>2</sub> mm	ORDER NO.
Retaining stud for 183.200/201 "Biesse" chucks	8	12	<b>995.200.00</b>
Retaining stud for 183.210/211 "Biesse, Omlat, Bulleri, Busellato, Weeke and IMA" chucks	9	13	<b>995.201.00</b>
Retaining stud for 183.220/221 "Alberti-Masterwood" chucks	9	12,8	<b>995.202.00</b>
Retaining stud for 183.250/251 "SCM - Morbidelli" chucks	6,5	8,5	<b>995.250.00</b>
Retaining stud for "PS and Leuco" 183.400 chucks	M8		<b>995.400.00</b>

## Collet Chucks Clamp with MK2 Tapered Shank

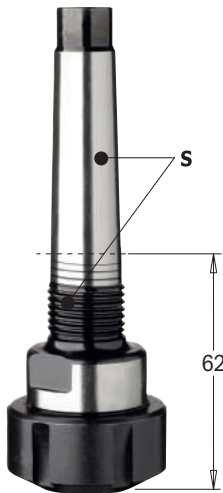

### 123

**RH LH**

S			ORDER NO. Right-hand rotation	ORDER NO. Left-hand rotation
MK2/Ø20x14F1"		1	<b>123.000.01</b>	<b>123.000.02</b>

**Spare parts**  
 992.123.01 Clamping nut RH  
 992.123.02 Clamping nut LH  
 991.123.00 Type 45-50 c-spanner

## Collets for 123 Chucks



### 124

D <sub>3</sub> mm		ORDER NO.	D <sub>3</sub> mm		ORDER NO.
6	1	<b>124.060.00</b>	10	1	<b>124.100.00</b>
6,35	1	<b>124.064.00</b>	12	1	<b>124.120.00</b>
8	1	<b>124.080.00</b>	12,7	1	<b>124.127.00</b>
9,5	1	<b>124.095.00</b>	14	1	<b>124.140.00</b>

## Saw Blade Arbor with Parallel Shank

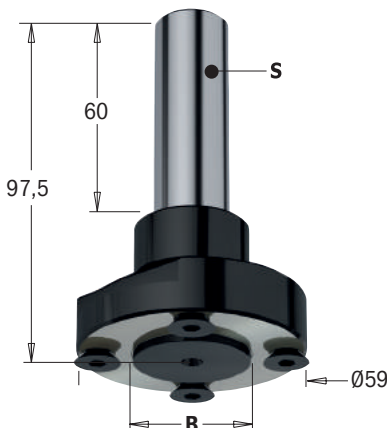

### 183.410

**LH RH**

S mm	D mm	B mm	PIN HOLE 	L mm		ORDER NO.
20	59	30	4/M6/48	97,5	1	<b>183.410.30</b>

**Spare parts**  
 990.116.00 M6x8,7x12mm TSPEI screw (to use with Plate Thickness ≥ 2,2mm)  
 991.067.00 3mm allen key  
 991.064.00 4mm allen key

Max saw blade  
Ø 250mm

**Optional**  
 990.083.00 M6x8x10mm TSPEI screw (to use with Plate Thickness < 2,2mm)

## HSK Chuck for Grooving Blade

new

**CMT ORANGE TOOLS®**

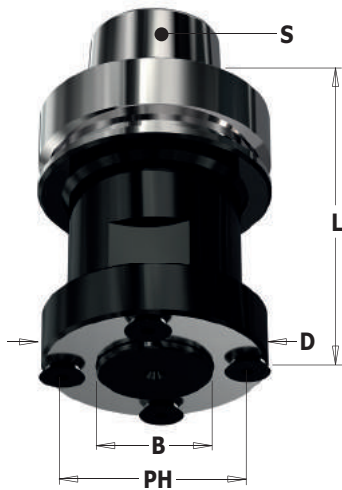

**183.420**

LH RH

S	D mm	B mm	PIN HOLE	L mm		ORDER NO.
HSK-63F	59	30	4/M6/48	78	1	<b>183.420.30</b>

**Spare parts** 990.116.00 M6x8,7x12mm TSPEI screw  
991.064.00 4mm allen key



Max saw blade  $\varnothing$ 250mm for chuck 183.420.30



Grooving saw blades available at page 38 or on request.

## HSK Chuck for Grooving Blade

new

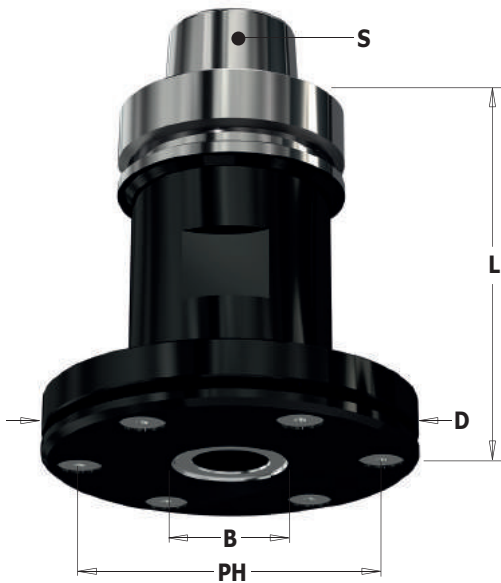

**183.421**

LH RH

S	D mm	B mm	PIN HOLE	L mm		ORDER NO.
HSK-63F	98	30	6/M6/80	102	1	<b>183.421.30</b>

with flange  $\varnothing$ 98mm

**Spare parts** 990.116.00 M6x8,7x12mm TSPEI screw  
991.064.00 4mm allen key



Max saw blade  $\varnothing$ 300mm for chuck 183.421.30



Grooving saw blades available on request.

## HSK Chuck for Grooving Blade

new

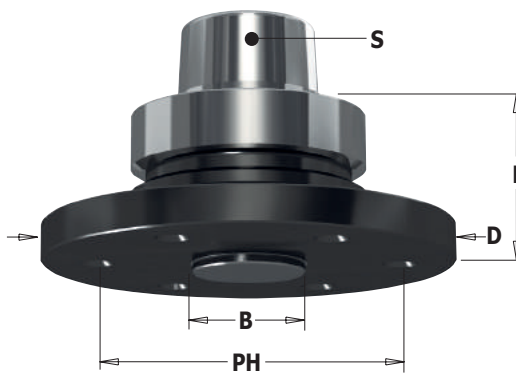

**183.422**

LH RH

S	D mm	B mm	PIN HOLE	L mm		ORDER NO.
HSK-63F	110	30	6/M6/80	40	1	<b>183.422.30</b>

**Spare parts** 990.116.00 M6x8,7x12mm TSPEI screw  
991.064.00 4mm allen key



Max saw blade  $\varnothing$ 350mm for chuck 183.422.30

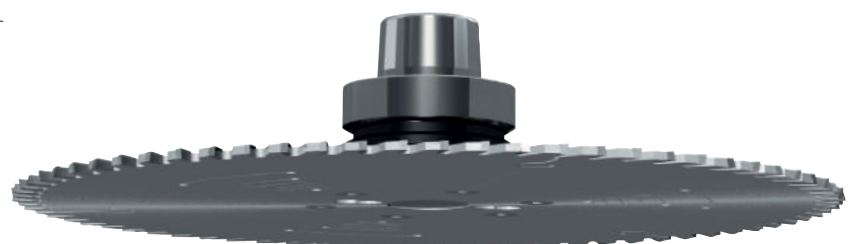

Grooving saw blades available on request.

## Cutter Arbor with HSK Tapered Shank

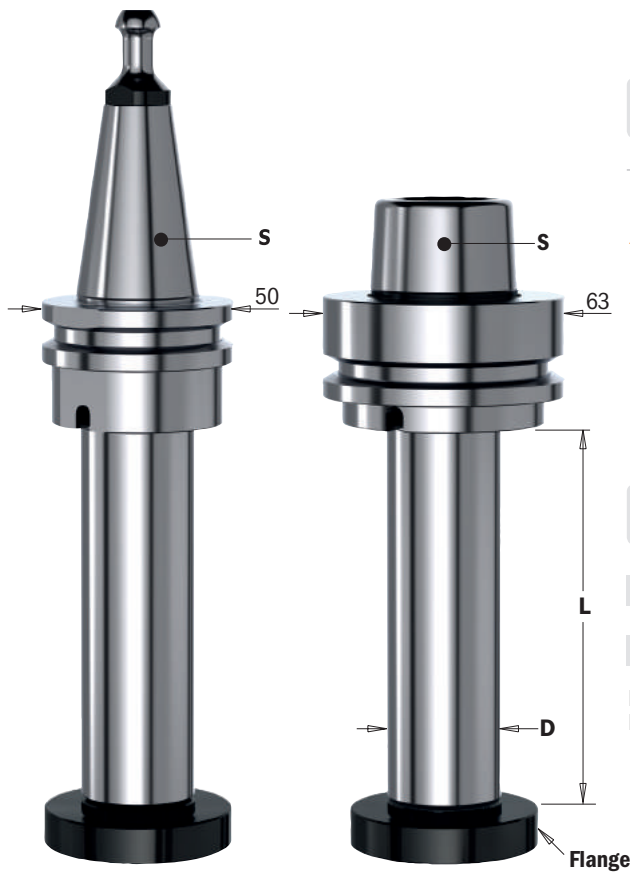

**183.260**

LH RH

S	DESCRIPTION	D x L mm		ORDER NO.
ISO30	Cutter arbor with ISO30 tapered shank	30x100	1	<b>183.260.00</b>

For Biesse machines.

**REMARK:** special dimensions available on request.

**183.360**

LH RH

S	DESCRIPTION	D x L mm		ORDER NO.
HSK-63F	Cutter arbor with HSK tapered shank	30x100	1	<b>183.360.00</b>
HSK-63F	Cutter arbor with HSK tapered shank	30x150	1	<b>183.360.10</b>
HSK-63F	Cutter arbor with HSK tapered shank	35x100	1	<b>183.361.00</b>
HSK-63F	Cutter arbor with HSK tapered shank	40x100	1	<b>183.362.00</b>

For Homag, Eima from 9/94, Dubus, Weeke, Biesse, SCM, Morbidelli and Masterwood machine.

## Spare Parts for Chucks



DESCRIPTION	ORDER NO.	DESCRIPTION	ORDER NO.
M6x25 TCEI screw	<b>990.098.00</b>	<b>Optional</b>	
Steel flange for with Ø30mm arbors - Male	<b>992.560.30M</b>	Steel flange for with Ø30mm arbors - Female	<b>992.560.30F</b>
Steel flange for with Ø35mm arbors - Male	<b>992.560.35M</b>	Steel flange for with Ø35mm arbors - Female	<b>992.560.35F</b>
Steel flange for with Ø40mm arbors - Male	<b>992.560.40M</b>	Steel flange for with Ø40mm arbors - Female	<b>992.560.40F</b>

## Universal Assembly Supports for Chucks



**183**

DESCRIPTION	D mm		ORDER NO.
Universal assembly supports for chucks HSK-63F	63	1	<b>183-HSK</b>
Universal assembly supports for chucks ISO30	50	1	<b>183-ISO</b>

For HSK-63F, BT40, ISO40 DIN 2080, SK40 DIN 69871, CAPTO C6 and ISO30, DIN 2080, SK30 DIN 69871, HSK50, CAPTO C5 chucks

CMT now offers new universal assembly supports for HSK-63F and ISO30 chucks. Thanks to the bi-directional roller bearings, which clamp the Left-hand rotation to the flange, the system offers the highest protection to the tool taper and clamps are no longer needed.

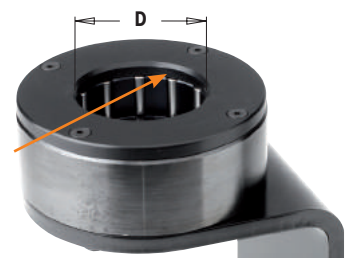





# XTREME COATING

## THE ULTIMATE TECHNOLOGY FOR INDUSTRIAL CNC TOOLS

DLCS is a modified diamond-like carbon coating with enhanced load bearing capacity. A hard, durable metal-based layer (chromium nitride) provides an higher hardness surface and increases the resilience of the superposed, tribologically effective carbon coating. Coating prevents high heats which is detrimental to cutting tool performance and will remain fully effective after use.

<p><b>Extreme Coating Hardness</b> <b>&gt;HV 2.500</b></p> <p>Offers impressive hardness on cutting areas of the tool and superb protection against abrasive wear and stress resistance.</p>	<p><b>Minimal coating thickness</b> <b>µm 2-4</b></p> <p>The minimal micron coating guaranteed perfect sharpen edges for high cutting quality.</p>	<p><b>The lowest coefficient of friction</b> <b>0,1-0,2</b></p> <p>Very good running-in and low friction losses. Reduction of sticking. Ideal for high speeds in Nesting applications.</p>	<p><b>High Working Temperature</b></p> <p>Less overheating! The coating guarantees working temperature up to 400° preserving the cutting edges from wear.</p>
--	--	--	---

## BENEFITS



**3X**  
LONGER LIFE  
THAN UNCOATED

**DLCS CHROME COATING**  
provides 3 times longer life  
than uncoated tools!



**Test performed in U.S. with 1/2" solid carbide compression spiral bit**

**MACHINE:** Felder Profit H10 Nested Base/Overhead CNC Router

**WORKING PARAMETERS:** RPM = 18,000 - Feed = 20 mts/minute

**MATERIAL:** 19mm Melamine Chipboard

**APPLICATION:** Nesting Full Dimensioning

**PERFORMANCE:** DLCS coated bit cut 165 melamine panels  
Uncoated bit cut 56 melamine panels

Felder Profit H10



DLCS coated bit



Melamine Chipboard



Cut quality after 165 panels

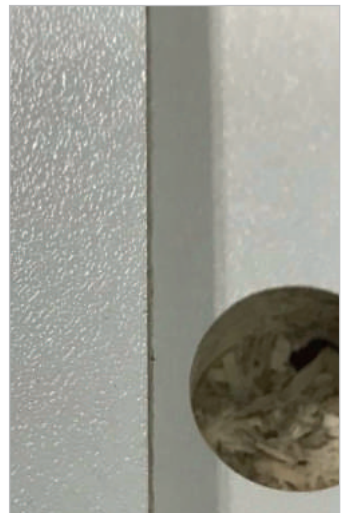

# Solid Carbide Upcut & Downcut Spiral Bits

new

**CMT ORANGE TOOLS®**



EXTRA HARD  
**DLCS CHROME COATING**

**3X**  
LONGER LIFE  
THAN UNCOATED

## 190.41 DLCS Chrome Coating Long Life

HWM Z2+2 Z3+3 RH LONG LIFE

D mm	I mm	I <sub>1</sub> mm	L mm	S mm	Z		ORDER NO. Right-hand rotation
9,52	28,6	7	76,2	9,52	2+2	10	<b>190.504.41</b>
12	42	7	90	12	2+2	10	<b>190.120.41</b>
12	52	7	100	12	2+2	10	<b>190.121.41</b>
12,7	25,4	12	76,2	12,7	2+2	10	<b>190.505.41</b>
12,7	28,6	12	76,2	12,7	2+2	10	<b>190.506.41</b>
12,7	34,9	12	88,9	12,7	2+2	10	<b>190.507.41</b>
12,7	41,3	12	101,6	12,7	2+2	10	<b>190.508.41</b>

### ...up & downcut mortising bits

9,52	22,2	4,8	76,2	9,52	2+2	10	<b>190.513.41</b>
9,52	25,4	5,2	76,2	9,52	3+3	10	<b>190.813.41</b>
12	25	5,2	83	12	3+3	10	<b>190.320.41</b>
12,7	22,2	5,2	76,2	12,7	2+2	10	<b>190.515.41</b>
12,7	34,9	5,2	88,9	12,7	2+2	10	<b>190.517.41</b>
12,7	28,5	6	76,2	12,7	3+3	10	<b>190.815.41</b>

### TECHNICAL DETAILS:

- Premium quality HWM.
- 2+2 spiral cutting edges [Z2+2].
- 3+3 spiral cutting edges [Z3+3].
- Provide an excellent finish on both the upper and the lower side of the workpiece.

### APPLICATION:

used for cutting, copying, panel sizing and any routing application on solid wood, wood composites, plastic materials and laminates. Use a high feed speed on well-clamped workpieces. Can be used on machining centres, point-to-point boring machines, CNC routers and hand-held routers equipped with chucks or adapters.

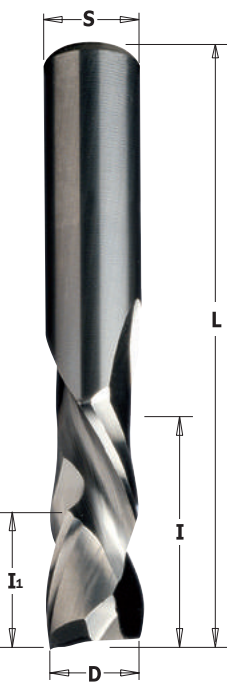

## 190

HWM Z1+1 Z2+2 Z3+3 RH

D mm	I mm	I <sub>1</sub> mm	L mm	S mm	Z		ORDER NO. Right-hand rotation
4	15	7	50	4	1+1	10	<b>190.040.11</b>
5	22	8	60	5	1+1	10	<b>190.050.11</b>
6	22	8	60	6	1+1	10	<b>190.060.11</b>
6,35	22,2	7	63,5	6,35	2+2	10	<b>190.008.11</b>
8	32	7	80	8	2+2	10	<b>190.080.11</b>
9,52	28,6	7	76,2	9,52	2+2	10	<b>190.504.11</b>
10	32	7	80	10	2+2	10	<b>190.100.11</b>
10	42	7	90	10	2+2	10	<b>190.101.11</b>
12	42	7	90	12	2+2	10	<b>190.120.11</b>
12	52	7	100	12	2+2	10	<b>190.121.11</b>
12,7	25,4	12	76,2	12,7	2+2	10	<b>190.505.11</b>
12,7	28,6	12	76,2	12,7	2+2	10	<b>190.506.11</b>
12,7	34,9	12	88,9	12,7	2+2	10	<b>190.507.11</b>
12,7	41,3	12	101,6	12,7	2+2	10	<b>190.508.11</b>
16	55	24	110	16	2+2	10	<b>190.160.11</b>
18	55	30	110	18	2+2	10	<b>190.180.11</b>

### ...up & downcut mortising bits

9,52	22,2	4,8	76,2	9,52	2+2	10	<b>190.513.11</b>
9,52	25,4	5,2	76,2	9,52	3+3	10	<b>190.813.11</b>
12	25	5,2	83	12	3+3	10	<b>190.320.11</b>
12,7	22,2	5,2	76,2	12,7	2+2	10	<b>190.515.11</b>
12,7	34,9	5,2	88,9	12,7	2+2	10	<b>190.517.11</b>
12,7	28,5	6	76,2	12,7	3+3	10	<b>190.815.11</b>

### TECHNICAL DETAILS:

- Premium quality HWM.
- 1+1 spiral cutting edges [Z1+1].
- 2+2 spiral cutting edges [Z2+2].
- 3+3 spiral cutting edges [Z3+3].
- Provide an excellent finish on both the upper and the lower side of the workpiece.

### APPLICATION:

used for cutting, copying, panel sizing and any routing application on solid wood, wood composites, plastic materials and laminates. Use a high feed speed on well-clamped workpieces. Can be used on machining centres, point-to-point boring machines, CNC routers and hand-held routers equipped with chucks or adapters.



Results shown in this diagram are purely empirical, based merely on informative and hypothetical calculation. Each application may require different parameters in consideration of materials in use and machining conditions. CMT is not responsible for direct, indirect, incidental or consequential damages resulting from any defect, error or failure due to this diagram.

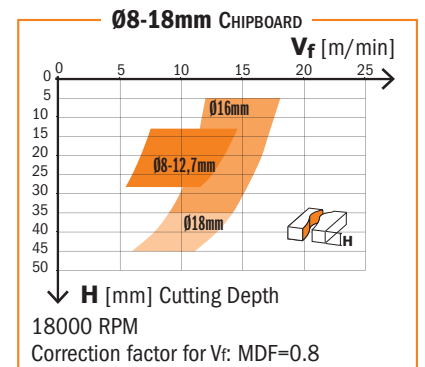
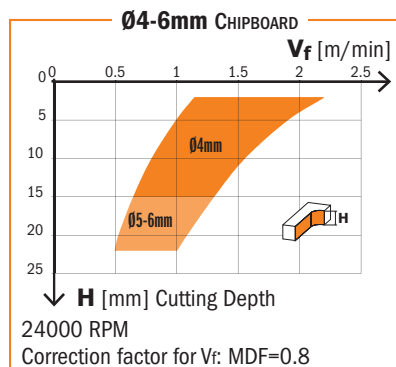

# Solid Carbide Upcut Spiral Bits

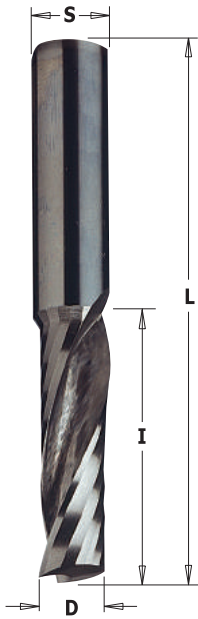

**198**



D mm	I mm	L mm	S mm		ORDER NO. Right-hand rotation
3	12	50	3	10	<b>198.030.11</b>
3,18	12,7	50,8	6,35	10	<b>198.001.11</b>
4	15	50	4	10	<b>198.040.11</b>
4,76	15,87	50,8	6,35	10	<b>198.005.11</b>
5	17	50	5	10	<b>198.050.11</b>
6	22	60	6	10	<b>198.060.11</b>
6,35	19,05	50,8	6,35	10	<b>198.007.11</b>
6,35	25,4	63,5	6,35	10	<b>198.008.11</b>
8	22	70	8	10	<b>198.080.11</b>
8	32	80	8	10	<b>198.081.11</b>
9,52	28,57	76,2	9,52	10	<b>198.504.11</b>
10	32	70	10	10	<b>198.100.11</b>
10	42	80	10	10	<b>198.101.11</b>
10	52	90	10	10	<b>198.102.11</b>
12	32	83	12	10	<b>198.120.11</b>

**TECHNICAL DETAILS:**

- Premium quality HWM.
- 1 spiral cutting edge [Z1].
- Provide an excellent finish on the lower side of the workpiece.
- **Upward chip ejection.**

**APPLICATION:**

used for cutting, copying, panel sizing and any routing applications on solid wood, wood composites, plastic materials and laminates. Use a high feed speed on well-clamped workpieces. Can be used on machining centres, point to point machines, CNC routers and hand-held routers equipped with chucks or adapters.

# Solid Carbide Downcut Spiral Bits

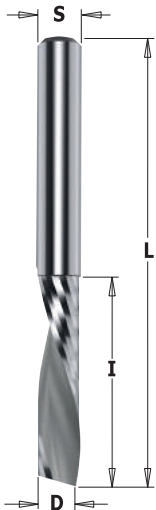

**198**



D mm	I mm	L mm	S mm		ORDER NO. Right-hand rotation
6	27	60	6	10	<b>198.660.11</b>

**TECHNICAL DETAILS:**

- Premium quality HWM.
- 1 spiral cutting edge [Z1].
- Provide an excellent finish on the top side of the workpiece.
- **Upward chip ejection.**

**APPLICATION:**

used for cutting, copying, panel sizing and any routing applications on solid wood, wood composites, plastic materials and laminates. Use a high feed speed on well-clamped workpieces. Can be used on machining centres, point to point machines, CNC routers and hand-held routers equipped with chucks or adapters.

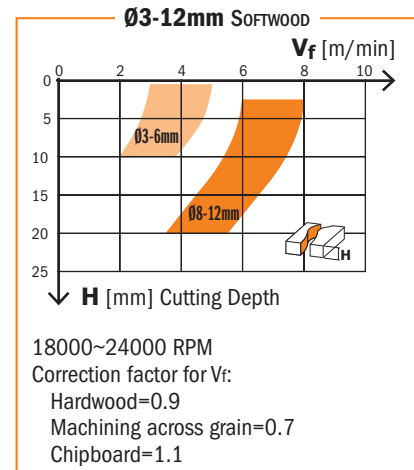
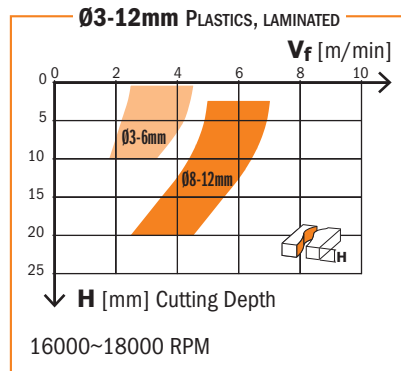

Results shown in this diagram are purely empirical, based merely on informative and hypothetical calculation. Each application may require different parameters in consideration of materials in use and machining conditions. CMT is not responsible for direct, indirect, incidental or consequential damages resulting from any defect, error or failure due to this diagram.



# Solid Carbide Upcut Spiral Bits

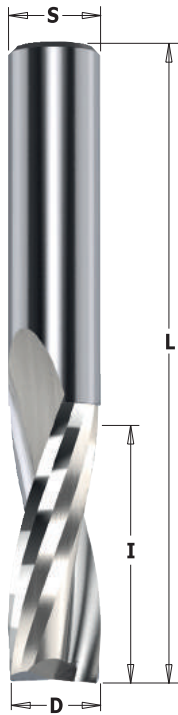

## 191

D mm	I mm	L mm	S mm		ORDER NO. Right-hand rotation
3	12	50	3	10	<b>191.030.11</b>
3	12	60	6	10	<b>191.630.11</b>
3	12	60	8	10	<b>191.830.11</b>
3,18	12,7	50,8	6,35	10	<b>191.001.11</b>
3,5	12	60	6	10	<b>191.635.11</b>
3,97	12,7	50,8	6,35	10	<b>191.003.11</b>
4	15	50	4	10	<b>191.040.11</b>
4	15	60	6	10	<b>191.640.11</b>
4	15	60	8	10	<b>191.840.11</b>
4,76	19,05	50,8	6,35	10	<b>191.005.11</b>
5	17	50	5	10	<b>191.050.11</b>
5	17	60	6	10	<b>191.650.11</b>
5	17	60	8	10	<b>191.850.11</b>
6	27	70	6	10	<b>191.060.11</b>
6	27	70	8	10	<b>191.860.11</b>
6,35	19,05	50,8	6,35	10	<b>191.007.11</b>
6,35	25,4	63,5	6,35	10	<b>191.008.11</b>
7	32	80	8	10	<b>191.870.11</b>
7,94	25,4	76,2	12,7	10	<b>191.501.11</b>
8	22	70	8	10	<b>191.080.11</b>
8	32	80	8	10	<b>191.081.11</b>
8	42	90	8	10	<b>191.082.11</b>
9	32	83	12	10	<b>191.890.11</b>
9,52	31,75	82,5	12,7	10	<b>191.503.11</b>
10	32	80	8	10	<b>191.800.11</b>
10	32	80	10	10	<b>191.100.11</b>
10	32	83	12	10	<b>191.900.11</b>
10	42	90	10	10	<b>191.101.11</b>
10	42	90	12	10	<b>191.901.11</b>
12	35	83	8	10	<b>191.820.11</b>
12	35	83	12	10	<b>191.120.11</b>
12	42	90	12	10	<b>191.121.11</b>
12	52	100	12	10	<b>191.122.11</b>
12,7	31,75	76,2	12,7	10	<b>191.505.11</b>
12,7	38,1	88,9	12,7	10	<b>191.506.11</b>
12,7	50,8	101,6	12,7	10	<b>191.507.11</b>
14	50	110	14	1	<b>191.140.11</b>
16	55	110	16	1	<b>191.160.11</b>
16	35	90	16	1	<b>191.161.11</b>
16	72	120	16	1	<b>191.165.11</b>
20	72	120	20	1	<b>191.200.11</b>

### Ø12-14mm PLASTICS, LAMINATED

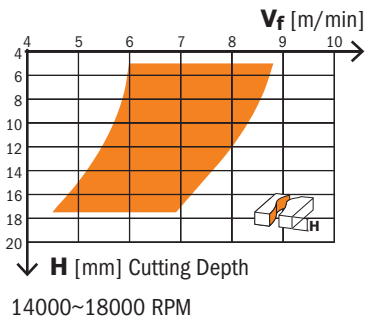

### Ø12-20mm SOFTWOOD

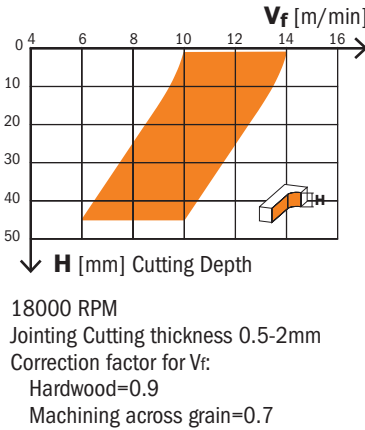

#### TECHNICAL DETAILS:

- Premium quality HWM.
- 2 spiral cutting edges [Z2].
- Provide an excellent finish on the lower side of the workpiece.
- **Upward chip ejection.**

#### APPLICATION:

used for ripping, template routing, panel sizing and any routing application on solid wood, wood composites, plastic materials and laminates. Can be used at a high feed speed on well-clamped workpieces. Can be used on machining centres, point-to-point boring machines, CNC routers and hand-held routers equipped with chucks or adapters.



Results shown in this diagram are purely empirical, based merely on informative and hypothetical calculation. Each application may require different parameters in consideration of materials in use and machining conditions. CMT is not responsible for direct, indirect, incidental or consequential damages resulting from any defect, error or failure due to this diagram.



## 192

D mm	I mm	L mm	S mm		ORDER NO. Right-hand rotation
3	12	50	3	10	<b>192.030.11</b>
3	12	60	6	10	<b>192.630.11</b>
3	12	60	8	10	<b>192.830.11</b>
3,18	12,7	50,8	6,35	10	<b>192.001.11</b>
3,97	12,7	50,8	6,35	10	<b>192.003.11</b>
4	15	50	4	10	<b>192.040.11</b>
4	15	60	6	10	<b>192.640.11</b>
4	15	60	8	10	<b>192.840.11</b>
4,76	19,05	50,8	6,35	10	<b>192.005.11</b>
5	17	50	5	10	<b>192.050.11</b>
5	17	60	6	10	<b>192.650.11</b>
5	17	60	8	10	<b>192.850.11</b>
6	27	70	6	10	<b>192.060.11</b>
6	27	70	8	10	<b>192.860.11</b>
6,35	19,05	50,8	6,35	10	<b>192.007.11</b>
6,35	25,4	63,5	6,35	10	<b>192.008.11</b>
7,94	25,4	76,2	12,7	10	<b>192.501.11</b>
8	22	70	8	10	<b>192.080.11</b>
8	32	80	8	10	<b>192.081.11</b>
8	42	90	8	10	<b>192.082.11</b>
9,52	31,75	82,5	12,7	10	<b>192.503.11</b>
10	32	80	8	10	<b>192.800.11</b>
10	32	80	10	10	<b>192.100.11</b>
10	42	90	10	10	<b>192.101.11</b>
10	32	83	12	10	<b>192.900.11</b>
12	35	83	8	10	<b>192.820.11</b>
12	35	83	12	10	<b>192.120.11</b>
12,7	31,75	76,2	12,7	10	<b>192.505.11</b>
12,7	38,1	88,9	12,7	10	<b>192.506.11</b>
12,7	50,8	101,6	12,7	10	<b>192.507.11</b>
14	52	110	14	1	<b>192.140.11</b>
16	55	110	16	1	<b>192.160.11</b>

### Ø12-14mm PLASTICS, LAMINATED

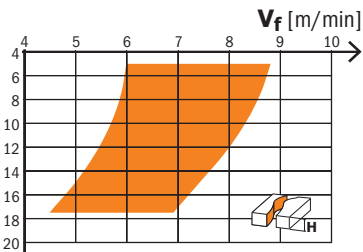

14000-18000 RPM

### Ø12-20mm SOFTWOOD

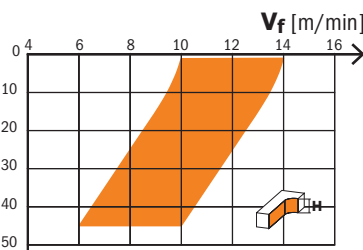

18000 RPM

Jointing Cutting thickness 0.5-2mm  
Correction factor for Vf:  
Hardwood=0.9  
Machining across grain=0.7

#### TECHNICAL DETAILS:

- Premium quality HWM.
- 2 spiral edges [Z2].
- Provide an excellent finish on the upper side of the workpiece.
- **Downward chip ejection.**

#### APPLICATION:

used for ripping, template routing, panel sizing and any routing application on solid wood, wood composites, plastic materials and laminates. Can be used at a high feed speed on small, difficult to clamp work pieces. Can be used on machining centres, point-to-point boring machines, CNC routers and hand-held routers equipped with chucks or adapters.



Results shown in this diagram are purely empirical, based merely on informative and hypothetical calculation. Each application may require different parameters in consideration of materials in use and machining conditions. CMT is not responsible for direct, indirect, incidental or consequential damages resulting from any defect, error or failure due to this diagram.

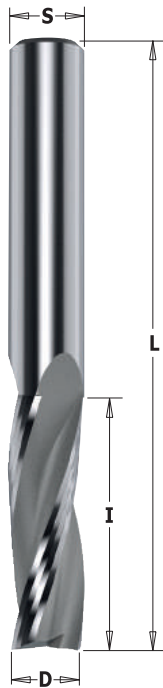

## 193



D mm	I mm	L mm	S mm		ORDER NO. Right-hand rotation	ORDER NO. Left-hand rotation
8	32	80	8	10	<b>193.081.11</b>	<b>193.081.12</b>
10	32	80	10	10	<b>193.100.11</b>	<b>193.100.12</b>
10	42	90	10	10	<b>193.101.11</b>	
12	35	83	12	10	<b>193.120.11</b>	<b>193.120.12</b>
12	42	90	12	10	<b>193.121.11</b>	
12	52	100	12	10	<b>193.122.11</b>	
14	58	110	14	1	<b>193.140.11</b>	
16	55	110	16	1	<b>193.160.11</b>	<b>193.160.12</b>
16	35	90	16	1	<b>193.161.11</b>	
16	72	120	16	1	<b>193.165.11</b>	
18	55	110	18	1	<b>193.180.11</b>	
20	60	120	20	1	<b>193.200.11</b>	<b>193.200.12</b>
20	70	120	20	1	<b>193.201.11</b>	

### TECHNICAL DETAILS:

- Premium quality HWM.
- 3 spiral cutting edges [Z3].
- Provide an excellent finish on the lower side of the workpiece.
- **Upward chip ejection.**

### APPLICATION:

used for ripping, template routing, panel sizing and any routing application on solid wood, or wood composites. Can be used at a high feed speed on well-clamped workpieces.  
Can be used on machining centres, point-to-point boring machines, CNC routers and hand-held routers equipped with chucks or adapters.

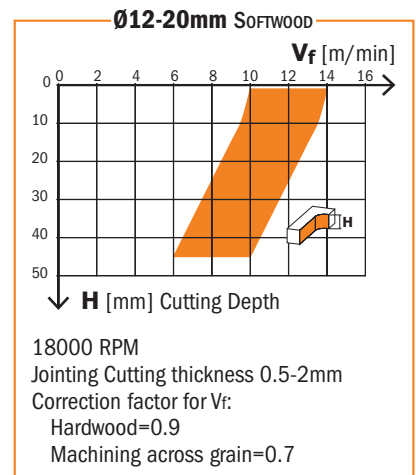
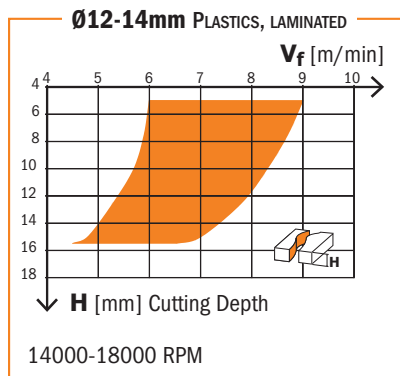

Results shown in this diagram are purely empirical, based merely on informative and hypothetical calculation. Each application may require different parameters in consideration of materials in use and machining conditions. CMT is not responsible for direct, indirect, incidental or consequential damages resulting from any defect, error or failure due to this diagram.



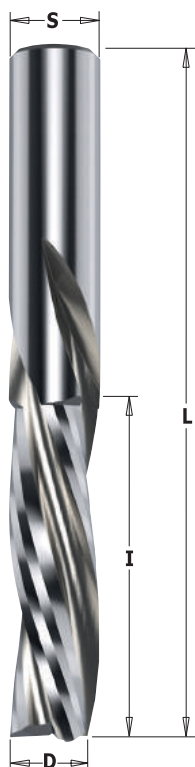

## 194



D mm	I mm	L mm	S mm		ORDER NO. Right-hand rotation	ORDER NO. Left-hand rotation
10	32	80	10	10	<b>194.100.11</b>	
10	42	90	10	10	<b>194.101.11</b>	
12	35	83	12	10	<b>194.120.11</b>	<b>194.120.12</b>
12	42	90	12	10	<b>194.121.11</b>	
14	50	110	14	1	<b>194.140.11</b>	
16	55	110	16	1	<b>194.160.11</b>	<b>194.160.12</b>
16	35	90	16	1	<b>194.161.11</b>	
18	55	110	18	1	<b>194.180.11</b>	
20	60	120	20	1	<b>194.200.11</b>	<b>194.200.12</b>
20	72	120	20	1	<b>194.201.11</b>	
20	102	165	20	1	<b>194.202.11</b>	

### TECHNICAL DETAILS:

- Premium quality HWM.
- 3 spiral cutting edges [Z3].
- Provide an excellent finish on the upper side of the workpiece.
- **Downward chip ejection.**

### APPLICATION:

used for ripping, template routing, panel sizing and any routing application on solid wood, wood composites, plastic materials and laminates. Can be used at a high feed speed on small, difficult to clamp workpieces.

Can be used on machining centres, point-to-point boring machines, CNC routers and hand-held routers equipped with chucks or adapters.

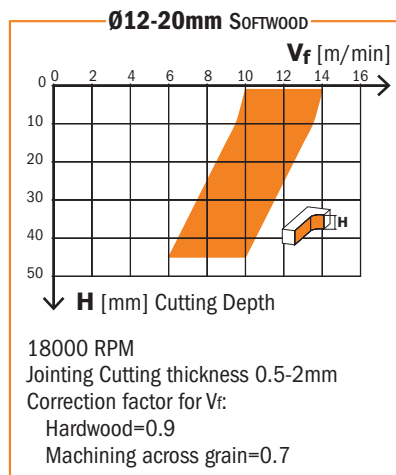
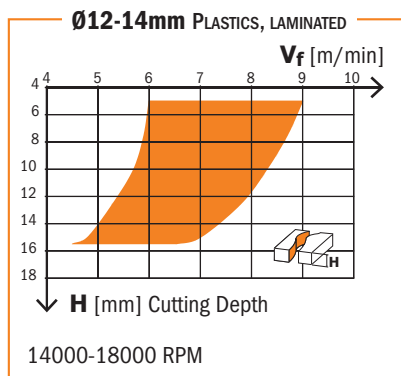

Results shown in this diagram are purely empirical, based merely on informative and hypothetical calculation. Each application may require different parameters in consideration of materials in use and machining conditions. CMT is not responsible for direct, indirect, incidental or consequential damages resulting from any defect, error or failure due to this diagram.

# Solid Carbide Upcut Spiral Bits with Chip-Breaker

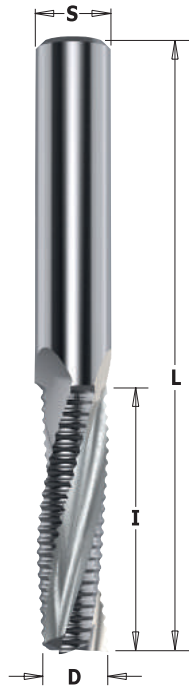

## 195



D mm	I mm	L mm	S mm		ORDER NO. Right-hand rotation	ORDER NO. Left-hand rotation
8	32	80	8	10	195.081.11	195.081.12
8	42	90	8	10	195.082.11	
10	32	80	10	10	195.100.11	195.100.12
10	42	90	10	10	195.101.11	
12	35	83	12	10	195.120.11	195.120.12
12	42	90	12	10	195.121.11	
12	52	100	12	10	195.122.11	
12,7	38,1	88,9	12,7	10	195.506.11	
14	58	110	14	1	195.140.11	
16	55	110	16	1	195.160.11	195.160.12
16	35	90	16	1	195.161.11	
16	72	120	16	1	195.165.11	
18	55	110	18	1	195.180.11	
20	60	120	20	1	195.200.11	195.200.12
20	72	120	20	1	195.201.11	
20	102	165	20	1	195.202.11	

### APPLICATION:

used for ripping, template routing, panel sizing and any routing application on solid wood, or wood composites. Can be used at a high feed speed on well-clamped workpieces.

Can be used on machining centres, point-to-point boring machines, CNC routers and hand-held routers equipped with chucks or adapters.

### TECHNICAL DETAILS:

- Premium quality HWM.
- 3 spiral cutting edges [Z3R].
- Chip breaker teeth.
- Max 0.3mm tooth depth.
- Provide an excellent finish on the lower side of the workpiece.
- **Upward chip ejection.**



Results shown in this diagram are purely empirical, based merely on informative and hypothetical calculation. Each application may require different parameters in consideration of materials in use and machining conditions. CMT is not responsible for direct, indirect, incidental or consequential damages resulting from any defect, error or failure due to this diagram.

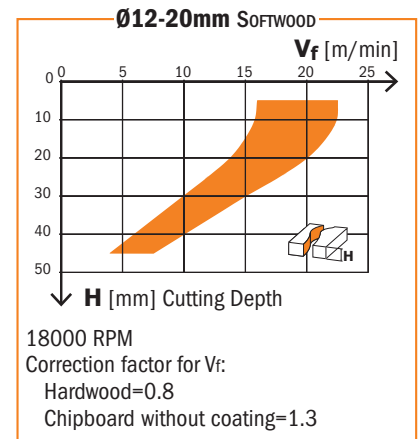
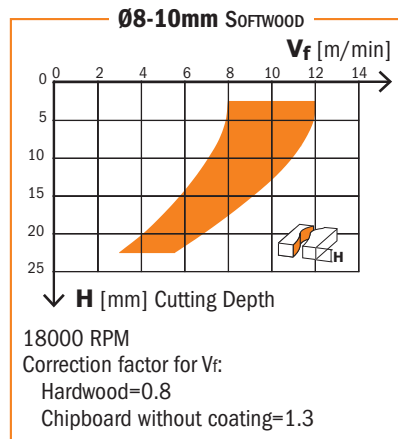

# Solid Carbide Upcut Spiral Bits

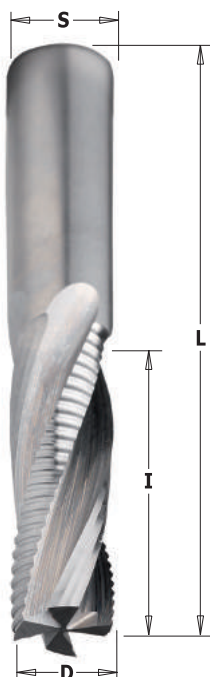

## 197



D mm	I mm	L mm	S mm		ORDER NO. Right-hand rotation	
12	42	90	12	10	197.121.11	
14	50	110	14	1	197.140.11	
16	55	110	16	1	197.160.11	
16	35	90	16	1	197.161.11	
18	55	110	18	1	197.180.11	
20	60	120	20	1	197.200.11	
20	70	120	20	1	197.201.11	

### TECHNICAL DETAILS:

- Premium quality HWM.
- 4 spiral cutting edges (2 with chip-breaker) [Z2+2R].
- Max 0.1mm tooth depth.
- Provide excellent finish on the lower side of the workpiece.
- **Upward chip ejection.**

### APPLICATION:

used for ripping, template routing, panel sizing and any routing application on solid wood and wood composites. Can be used on machining centres, point-to-point boring machines, CNC routers and hand-held routers equipped with chucks or adapters.

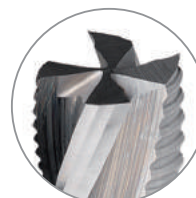

**The special 4 flute design (Z2 finishing + Z2R with chipbreaker) allows high speed with excellent finish on the workpiece.**

# Solid Carbide Downcut Spiral Bits with Chip-Breaker

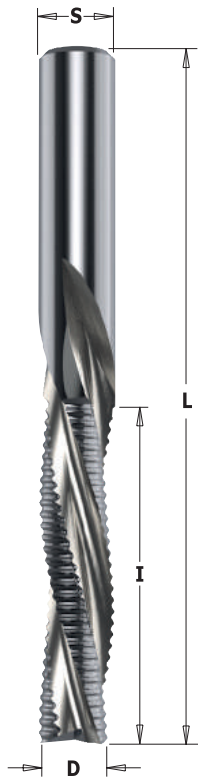

## 196



D mm	I mm	L mm	S mm		ORDER NO. Right-hand rotation	ORDER NO. Left-hand rotation
8	32	80	8	10	<b>196.081.11</b>	
10	42	90	10	10	<b>196.101.11</b>	
12	35	83	12	10	<b>196.120.11</b>	<b>196.120.12</b>
12	42	90	12	10	<b>196.121.11</b>	
12	52	100	12	10	<b>196.122.11</b>	
12,7	38,1	88,9	12,7	10	<b>196.506.11</b>	
14	50	110	14	1	<b>196.140.11</b>	
16	55	110	16	1	<b>196.160.11</b>	<b>196.160.12</b>
18	55	110	18	1	<b>196.180.11</b>	
20	60	120	20	1	<b>196.200.11</b>	<b>196.200.12</b>
20	72	120	20	1	<b>196.201.11</b>	

### TECHNICAL DETAILS:

- Premium quality HWM.
- 3 spiral cutting edges [Z3R].
- Chip breaker teeth.
- Max 0.3mm tooth depth.
- Provide excellent finish on the upper side of the workpiece.
- **Downward chip ejection.**

### APPLICATION:

used for ripping, template routing, panel sizing and any routing application on solid wood and wood composites.  
Can be used on machining centres, point-to-point boring machines, CNC routers and hand-held routers equipped with chucks or adapters.

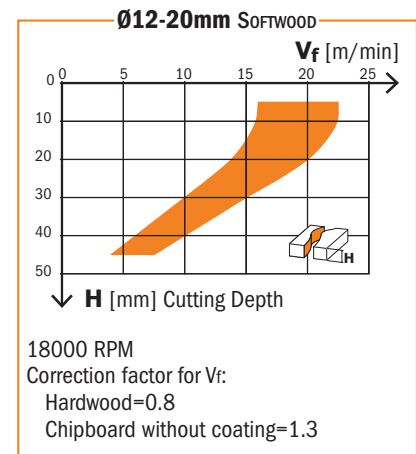
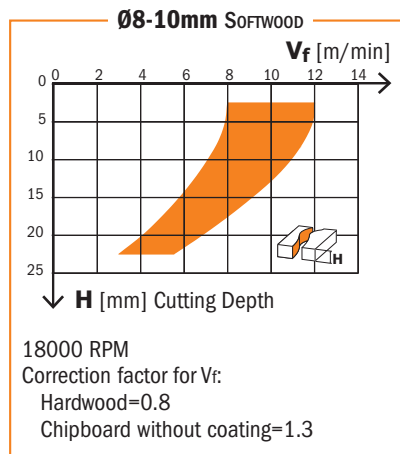

Results shown in this diagram are purely empirical, based merely on informative and hypothetical calculation. Each application may require different parameters in consideration of materials in use and machining conditions. CMT is not responsible for direct, indirect, incidental or consequential damages resulting from any defect, error or failure due to this diagram.



## Solid Carbide Upcut Spiral Bits for Locksets

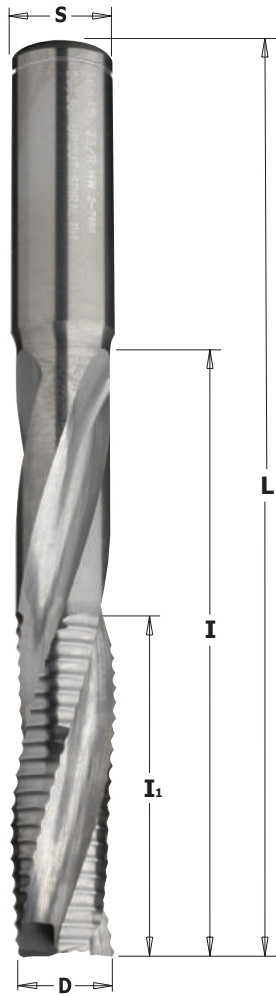

### 195



D mm	I mm	I <sub>1</sub> mm	L mm	S mm		ORDER NO. Right-hand rotation
<b>With Chip-Breaker</b>						
14	95*	45	150	14	1	<b>195.142.11</b>
14	125*	45	170	14	1	<b>195.144.11</b>
16	95*	45	150	16	1	<b>195.162.11</b>
16	120*	50	170	16	1	<b>195.164.11</b>
18	95*	45	150	18	1	<b>195.182.11</b>
<b>Without Chip-Breaker</b>						
16	95*	45	150	16	1	<b>193.162.11</b>

\* The maximum cutting length is achieved in 2-3 passes.

**TECHNICAL DETAILS:**

- Premium quality HWM.
- 3 spiral cutting edges [Z3] and [Z3R].
- Max 0.3mm tooth depth.
- Provide an excellent finish on the lower side of the workpiece.
- Seat for seeger ring (*not included*).
- **Upward chip ejection.**

**APPLICATION:**

used for ripping, template routing, panel sizing and any routing application on solid wood, or wood composites. Can be used at a high feed speed on well-clamped workpieces. Can be used on machining centres, point-to-point boring machines, CNC routers and hand-held routers equipped with chucks or adapters.

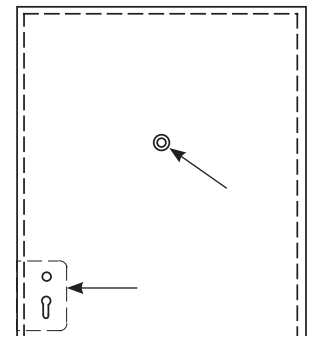
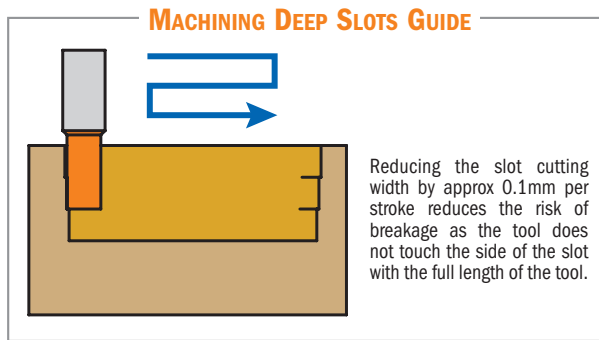

## Solid Carbide Upcut with Spiral Bits Chip-Breaker for 60° V-Point Locksets

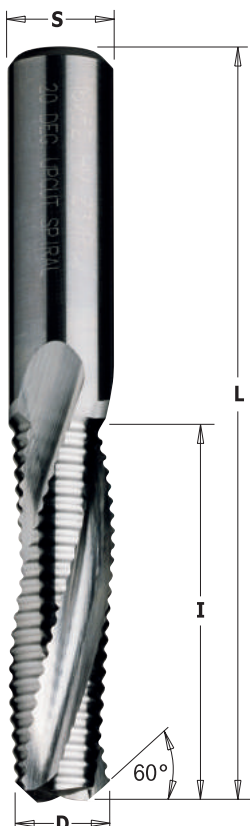

### 195.143/163



D mm	I mm	L mm	S mm		ORDER NO. Right-hand rotation
14	58	110	14	1	<b>195.143.11</b>
16	55	110	16	1	<b>195.163.11</b>

## Solid Carbide Upcut Spiral Bits without Chip-Breaker for 60° V-Point Locksets

### 191.143/163



D mm	I mm	L mm	S mm	PACK QTY.	ORDER NO. Right-hand rotation
14	50	110	14	1	<b>191.143.11</b>
16	55	110	16	1	<b>191.163.11</b>

**TECHNICAL DETAILS:**

- Premium quality HWM.
- 3 spiral cutting edges [Z3].
- Provide an excellent finish on the lower side of the workpiece.
- **Upward chip ejection.**

**APPLICATION:**

used for ripping, template routing, panel sizing and any routing application on solid wood, or wood composites. Can be used at a high feed speed on well-clamped workpieces. Can be used on machining centres, point-to-point boring machines, CNC routers and hand-held routers equipped with chucks or adapters.

# Spiral Bits with Insert Knives & Chip-Breaker for Locksets

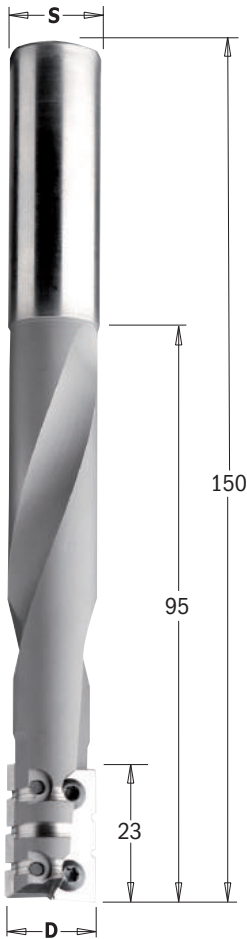

## 662



D mm	I mm	L mm	S mm		ORDER NO. Right-hand rotation
16	23/95*	150	16	1	<b>662.160.11</b>

**Spare parts**

790.230.2R	23x7x1.5mm 2-RT HWM knives (Minimum 10 pieces or multiple)
790.230.2R-X2	23x7x1.5mm 2-RT HWM knives (2-piece pack)
790.230.3R	23x7x1.5mm 3-RT HWM knives (Minimum 10 pieces or multiple)
790.230.3R-X2	23x7x1.5mm 3-RT HWM knives (2-piece pack)
990.082.00	M3x4x5.7mm T8 Torx TCPTI screw
991.063.00	T8 Torx key

\* The 95mm length is achieved in 4-5 passes.

### TECHNICAL DETAILS:

- Densimet® tungsten heavy metal alloys for low-vibration.
- 2 cutting edges [Z2R].
- Chip-breaker teeth.

### APPLICATION:

used for ripping, template routing, panel sizing and any routing application on solid wood, or wood composites. Can be used at a high feed speed on well-clamped workpieces.

Can be used on machining centres, point-to-point boring machines, CNC routers and hand-held routers equipped with chucks or adapters.

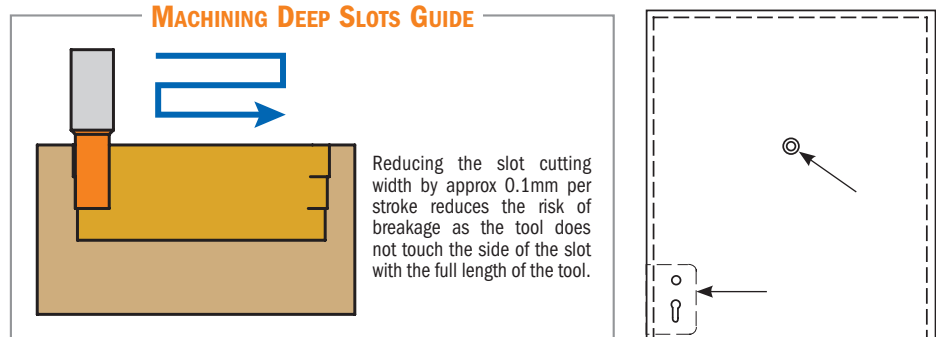

# Upcut Spiral Bits with Chipbreaker for Glue-Laminated Wooden Beams



## 195



D mm	I mm	L mm	S mm		ORDER NO. Right-hand rotation
□ 30	170	235	30	1	<b>Y195.300.51</b>
40	165	235	30	1	<b>195.400.51</b>
50	215	295	30	1	<b>195.500.51</b>

### □ On request

We manufacture bits without chipbreaker, with left-hand rotation and also in custom dimensions.

### TECHNICAL DETAILS:

- High speed cobalt steel.
- 3 upcut spiral cutting edges with chipbreaker [Z3R].
- Resharpener cutters.
- Max 6000~10000 RPM.
- Maximum feed speed 2m/minute.
- **Upward chip ejection.**

### APPLICATION:

used for cutting, copying, and routing on glue-laminated wooden beams. For use on Hundegger machines.

# Solid Carbide Upcut 2D/3D Carving Tapered Ball Nose Spiral Bits

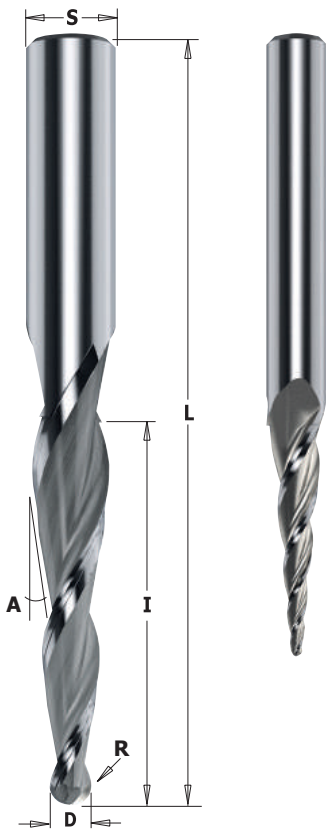

**152**

D mm	R mm	A	I mm	L mm	S mm	Z		ORDER NO. Right-hand rotation
0,8	0,4	5,5°	25	70	6	3	10	<b>152.060.082</b>
0,8	0,4	6,2°	25,4	76,2	6,35	3	10	<b>152.064.082</b>
1,6	0,8	4,5°	25	70	6	3	10	<b>152.060.162</b>
1,6	0,8	5,4°	25,4	76,2	6,35	3	10	<b>152.064.162</b>
1,6	0,8	5,5°	30	80	8	3	10	<b>152.080.163</b>
2	1	3°	80	120	12	2	10	<b>152.120.208</b>
3,2	1,6	2,5°	30	70	6	3	10	<b>152.060.323</b>
3,2	1,6	3,6°	25,4	76,2	6,35	3	10	<b>152.064.322</b>
3,2	1,6	2,5°	50	90	8	3	10	<b>152.080.325</b>
6	3	3°	50	100	12	2	10	<b>152.120.605</b>
6,4	3,2	3°	50,8	101,6	12,7	2	10	<b>152.127.635</b>

**TECHNICAL DETAILS:**

- Premium quality HWM.
- Upcut spiral cutting edges [Z2/Z3].
- **Excellent finish on the lower side of the work piece.**
- Upward chip ejection.

**APPLICATION:**

- specially designed for 2D and 3D CNC profiling and carving in plastic, aluminum & wood for several uses like:
- A perfect bit for 3D carving
  - Precision 2D and 3D large scale carving
  - Great for deep profiling
  - Dimensional signage
  - 3D millwork
  - 2D and 3D contouring, profiling, modeling and pattern making for cabinetry, sign making, furniture making and jewelry mold making
  - Perfect for model-makers on large 3D milling profiles in abrasive EPS foam and other materials.
  - **Ideal on aluminum, plastic and wood-based materials.**

**EXCELLENT FOR CUTTING:**

- Acrylonitrile-Butadiene-Styrene (ABS)
- Acrylic
- Acrylic Stone
- Aluminum
- Brass
- Bronze
- Composite
- Copper
- Corian®
- Coroplast®
- Dibond®
- Ethafoam®
- Ethylene-vinyl Acetate Foam (EVA)
- Expanded Polypropylene (EPP)

- Expanded Polystyrene Foam (EPS)
- Extruded Polystyrene Foam (XPS)
- Fiberglass
- Fiberglass PCB Board
- Foam Board
- Graphite
- HDPE
- HDU
- 20lbs High Density Urethane
- Lexan®
- MDF/HDF
- PALFOAM™
- Phenolics
- Phenolic Composites

- Plastics
- Poly (methyl methacrylate) (PMMA)
- Polyethylene Foam
- Polyam®
- Polyurethane Foam
- PVC
- PVC Foam Board
- Sign Board
- Sign Foam
- Titanium
- Tooling Board
- Wood
- XPE (Cross Linked Polyethylene) Foam

**TIPS FOR MILLING PLASTICS**

- pay attention to heat input
- pay attention to chip-loads when using small diameters
- use air-blast to keep chip away and cooling the tool

# Round Nose Solid Carbide Upcut Spiral Bits

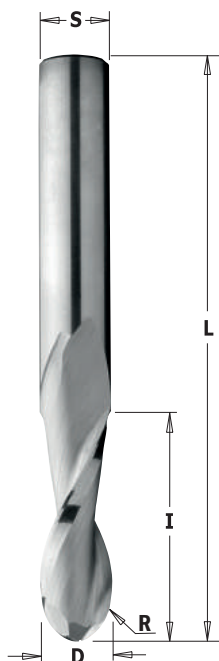

**199**



D mm	R mm	I mm	L mm	S mm		ORDER NO. Right-hand rotation
3,18	1,6	12,7	50,8	6,35	10	<b>199.001.11</b>
6	3	27	70	6	10	<b>199.060.11</b>
6,35	3,18	25,4	63,5	6,35	10	<b>199.008.11</b>
8	4	32	80	8	10	<b>199.081.11</b>
9,52	4,76	28,57	76,2	9,52	10	<b>199.504.11</b>
10	5	32	80	10	10	<b>199.100.11</b>
12	6	35	80	12	10	<b>199.120.11</b>
12,7	6,35	31,75	76,2	12,7	10	<b>199.505.11</b>
15,88	7,94	57,15	109,5	15,88	1	<b>199.509.11</b>
16	8	55	110	16	1	<b>199.160.11</b>
19,05	9,52	57,15	109,5	19,05	1	<b>199.511.11</b>

**TECHNICAL DETAILS:**

- Premium quality HWM.
- 2 upcut spiral cutting edges [Z2].
- Excellent finish on the lower side of the work piece.
- **Upward chip ejection.**

**APPLICATION:**

- used for ripping, template routing, panel sizing and any routing application on solid wood, wood composites, plastic materials and laminates. Can be used at a high feed speed on well-clamped workpieces. For use on machining centers, point-to-point boring machines, CNC routers and hand-held routers equipped with chucks or adapters.



# Solid Surface and Fiberglass Bit with DLCS Chrome Coating

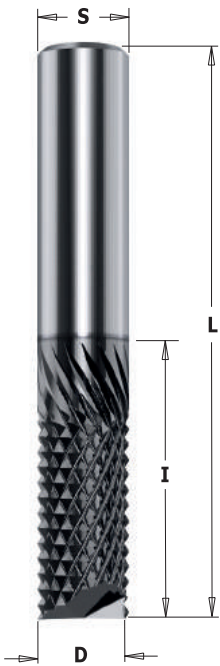

**151 XREME PERFORMANCE**



D mm	I mm	L mm	S mm		ORDER NO. Right-hand rotation
6	19	60	6	10	<b>151.060.19E</b>
6,35	25,4	63,5	6,35	10	<b>151.064.25E</b>
8	25	60	8	10	<b>151.080.25E</b>
12	25	75	12	10	<b>151.120.25E</b>
12,7	38	89	12,7	10	<b>151.127.38E</b>

**TECHNICAL DETAILS:**

- Premium quality HWM
- Special positively ground cutting edge sharpening for excellent finish
- AlTiN coated

**APPLICATION:**

for drilling, sizing and jointing fiberglass, phenolic and solid surfaces. Can be used on machining centres, point to point machines, CNC routers and hand held routers equipped with chucks or adapters.



**DLCS CHROME COATING:**

- Superb wear resistance
- Better chip clearance
- Superior cutting quality
- Less overheating
- More productivity



**DLCS CHROME COATING**  
provides 3 times longer life  
than uncoated tools!

# Solid Surface and Fiberglass Bit with DLCS Chrome Coating



**151 XREME PERFORMANCE**



D mm	I mm	L mm	S mm		ORDER NO. Right-hand rotation
6	19	60	6	10	<b>151.060.19D</b>
6,35	25,4	63,5	6,35	10	<b>151.064.25D</b>
8	25	60	8	10	<b>151.080.25D</b>
12	25	75	12	10	<b>151.120.25D</b>
12,7	38	89	12,7	10	<b>151.127.38D</b>

**TECHNICAL DETAILS:**

- Premium quality HWM
- Special positively ground cutting edge sharpening for excellent finish
- AlTiN coated

**APPLICATION:**

for drilling, sizing and jointing fiberglass, phenolic and solid surfaces. The 135° tooth geometry allows vertical feeding minimizing the bending of the workpiece. Can be used on machining centres, point to point machines, CNC routers and hand held routers equipped with chucks or adapters.



**DLCS CHROME COATING:**

- Superb wear resistance
- Better chip clearance
- Superior cutting quality
- Less overheating
- More productivity

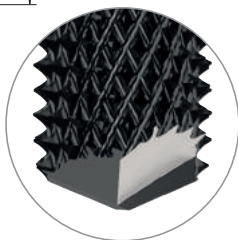

Sharpening 135°



**DLCS CHROME COATING**  
provides 3 times longer life  
than uncoated tools!

## DP Router Cutters with Negative Shear Angle



### 141 (HWM tool body)



D mm	I mm	L mm	S mm	Z		ORDER NO. Right-hand rotation
6	10	60	6	1 neg.	1	<b>141.260.61</b>
8	15	65	8	1 neg.	1	<b>141.280.61</b>
10	15	65	10	1 neg.	1	<b>141.300.61</b>
12	20	70	12	1 neg.	1	<b>141.320.61</b>

#### TECHNICAL DETAILS:

- Special super-micrograin carbide formulation
- Straight cutting edge.
- DP (H3).
- Resharpener cutter (max 3 times).
- Feed speed on MDF 3-4 m/min for cutter Ø6 and Ø8mm and 4-5m/minute for Ø10 and Ø12mm

**APPLICATION:** to be used on all CNC routers for jointing and sizing of solid wood and wood-based panels.



Negative Cutting Edge

## DP Router Cutters



### 141



D mm	I mm	L mm	S mm	Z		ORDER NO. Right-hand rotation
6	8	65	12x40	1	1	<b>141.060.61</b>
8	12	65	12x40	1	1	<b>141.080.61</b>
*10	22	75	12x40	1+1	1	<b>141.101.61</b>

#### TECHNICAL DETAILS:

- Super strength steel.
- DP cutting edge (H2,5).
- HW plunging tip for diagonal plunge-cutting.
- Resharpener cutter (max 3 times).
- Max feed speed 4 m/min.

**APPLICATION:** to be used on all CNC routers for jointing and sizing of solid wood and wood-based panels.

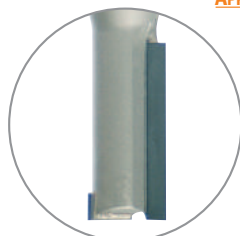

\* Construction Z1+1 for 141.101.61 item

# DP Router Cutters with Shear Angle



**140**



D mm	I mm	L mm	S mm	Z		ORDER NO. Right-hand rotation
10	25	72	12x40	1+1 (3 DP+1 HW)	1	<b>140.03956</b>
12	27	75	12x40	1+1 (3 DP+1 HW)	1	<b>140.120.61</b>
12	35	85	12x40	1+1 (4 DP+1 HW)	1	<b>140.121.61</b>
12,7	27	75	12,7x40	1+1 (4 DP+1 HW)	1	<b>140.127.61</b>
12,7	35	85	12,7x40	1+1 (4 DP+1 HW)	1	<b>140.128.61</b>
15,87	27	85	15,87x50	1+1 (3 DP+1 HW)	1	<b>140.158.61</b>
15,87	45	103	15,87x50	1+1 (5 DP+1 HW)	1	<b>140.159.61</b>
16	27	85	16x50	1+1 (3 DP+1 HW)	1	<b>140.160.61</b>
16	35	93	16x50	1+1 (4 DP+1 HW)	1	<b>140.161.61</b>
18	27	85	20x50	1+1 (3 DP+1 HW)	1	<b>140.180.61</b>
18	35	95	20x50	1+1 (4 DP+1 HW)	1	<b>140.181.61</b>
18	45	105	20x50	1+1 (5 DP+1 HW)	1	<b>140.182.61</b>
19,05	27	85	19,05x50	1+1 (3 DP+1 HW)	1	<b>140.190.61</b>
19,05	45	105	19,05x50	1+1 (5 DP+1 HW)	1	<b>140.192.61</b>
20	27	85	20x50	1+1 (3 DP+1 HW)	1	<b>140.200.61</b>
20	35	95	20x50	1+1 (4 DP+1 HW)	1	<b>140.201.61</b>
20	45	105	20x50	1+1 (5 DP+1 HW)	1	<b>140.202.61</b>
20	55	115	20x50	1+1 (6 DP+1 HW)	1	<b>140.203.61</b>

**TECHNICAL DETAILS:**

- Super strength steel.
- DP cutting edge (H2,5).
- HW plunging tip for diagonal plunge-cutting (Z-axis tool entrance).
- Resharpenable cutter (max 3 times).

**APPLICATION:**

to be used on all CNC routers for jointing, rabbeting, grooving and copying of raw material, melamine and laminates, MDF, HPL and veneered panels.



Results shown in this diagram are purely empirical, based merely on informative and hypothetical calculation. Each application may require different parameters in consideration of materials in use and machining conditions. CMT is not responsible for direct, indirect, incidental or consequential damages resulting from any defect, error or failure due to this diagram.

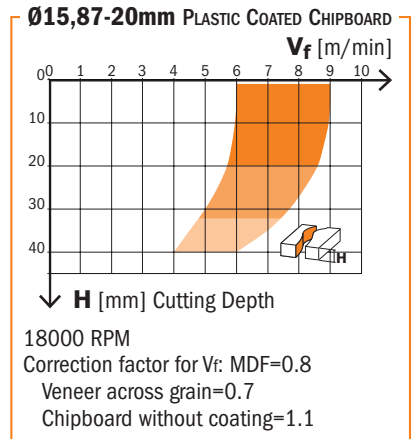
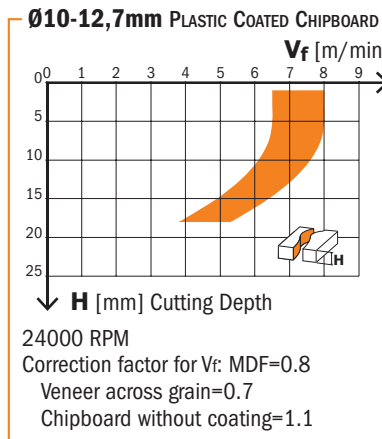

# DP Router Cutters with 45° Shear Angle

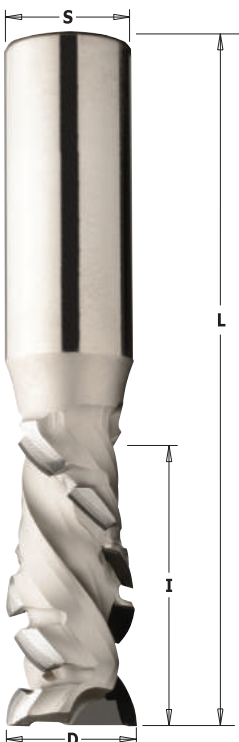

**140**



D mm	I mm	L mm	S mm	Z		ORDER NO. Right-hand rotation
20	25	85	20x50	1+1 (6 DP+1 HW)	1	<b>140.720.61</b>
20	35	95	20x50	1+1 (8 DP+1 HW)	1	<b>140.721.61</b>
20	45	105	20x50	1+1 (9 DP+1 HW)	1	<b>140.722.61</b>

**TECHNICAL DETAILS:**

- Super strength steel.
- Diamond cutting edges featuring 45° shear angle (H4).
- HW plunging tip for plunge cutting.
- Resharpenable cutters (max 8-9 times).

**APPLICATION:**

to be used on all CNC routers for jointing, rabbeting, grooving and copying of raw material, melamine and laminates, MDF, HPL and veneered panels.

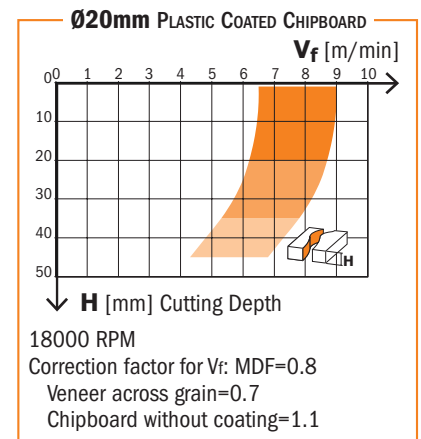



# DP Router Cutters with Shear Angle

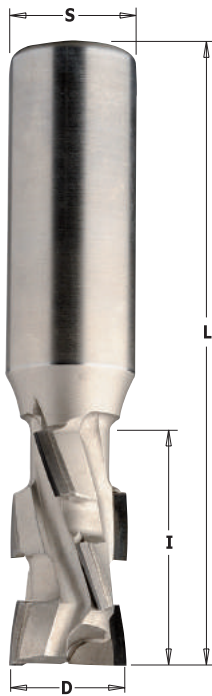

**142**



D mm	I mm	L mm	S mm	Z		ORDER NO. Right-hand rotation
20	27	85	20x50	2+2 (6 DP+1 HW)	1	<b>142.200.61</b>
20	36	95	20x50	2+2 (8 DP+1 HW)	1	<b>142.201.61</b>
20	45	105	20x50	2+2 (10 DP+1 HW)	1	<b>142.202.61</b>
20	55	115	20x50	2+2 (12 DP+1 HW)	1	<b>142.203.61</b>
25	27	90	25x55	2+2 (6 DP+1 HW)	1	<b>142.250.61</b>
25	36	100	25x55	2+2 (8 DP+1 HW)	1	<b>142.251.61</b>
25	45	110	25x55	2+2 (10 DP+1 HW)	1	<b>142.252.61</b>
25	55	120	25x55	2+2 (12 DP+1 HW)	1	<b>142.253.61</b>

**TECHNICAL DETAILS:**

- Super strength steel.
- DP cutting edge (H2,5).
- HW plunging tip for diagonal plunge-cutting (Z-axis tool entrance).
- Resharpener cutter (max 3 times).

**APPLICATION:**

to be used on all CNC routers for jointing, rabbeting, grooving, copying and dividing cuts of raw material, melamine and laminates, MDF, HPL and veneered panels.

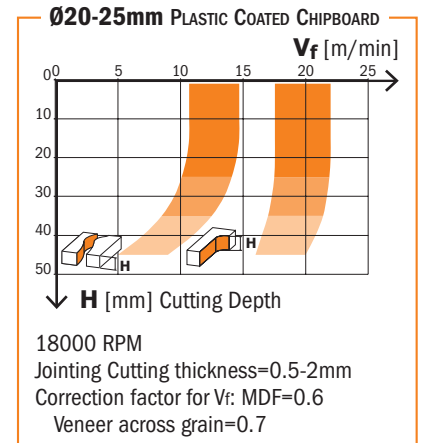

# DP Router Cutters with 20° Shear Angle



**142**



D mm	I mm	L mm	S mm	Z		ORDER NO. Right-hand rotation
20	25	85	20x45	2+2 (8 DP+1 HW)	1	<b>142.720.61</b>
20	30	90	20x45	2+2 (10 DP+1 HW)	1	<b>142.721.61</b>
20	35	95	20x45	2+2 (12 DP+1 HW)	1	<b>142.722.61</b>
20	40	100	20x45	2+2 (14 DP+1 HW)	1	<b>142.723.61</b>
20	45	105	20x45	2+2 (16 DP+1 HW)	1	<b>142.724.61</b>
20	50	110	20x45	2+2 (18 DP+1 HW)	1	<b>142.725.61</b>
20	55	115	20x45	2+2 (20 DP+1 HW)	1	<b>142.726.61</b>

**TECHNICAL DETAILS:**

- Super strength steel.
- Diamond cutting edges featuring 20° shear angle (H4).
- HW plunging tip for diagonal plunge-cutting (Z-axis tool entrance).
- Resharpener cutters (max 8-10 times).

**APPLICATION:**

used on all CNC routers for jointing, rabbeting, grooving, copying and dividing raw material, melamine, laminated, MDF, HPL and veneered panels.

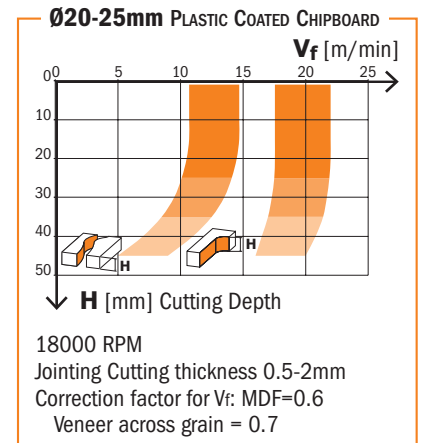

Results shown in this diagram are purely empirical, based merely on informative and hypothetical calculation. Each application may require different parameters in consideration of materials in use and machining conditions. CMT is not responsible for direct, indirect, incidental or consequential damages resulting from any defect, error or failure due to this diagram.

# DP Router Cutters with Shear Angle for Nesting (Densimet® Tungsten Heavy Metal Alloys)



**143**



D mm	I mm	L mm	S mm	Z		ORDER NO. Right-hand rotation
12	25	70	12x40	3 (9 DP)	1	<b>143.120.61</b>
12	31	80	12x40	3 (12 DP)	1	<b>143.121.61</b>

**TECHNICAL DETAILS:**

- Densimet® tungsten heavy metal alloys for low-vibration.
- DP cutting edge (H2,5).
- Resharpenable cutter (max 6 times).

**APPLICATION:**

to be used on all CNC routers for jointing, rabbeting, grooving, copying and dividing cuts of raw material, melamine and laminates, MDF, HPL and veneered panels.  
High performance on pre-and finish-routing.

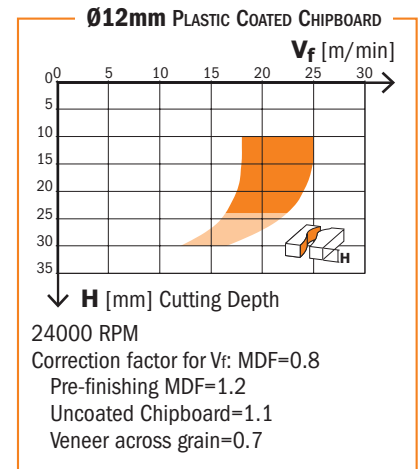

# DP Spiral Router Cutters with Shear Angle

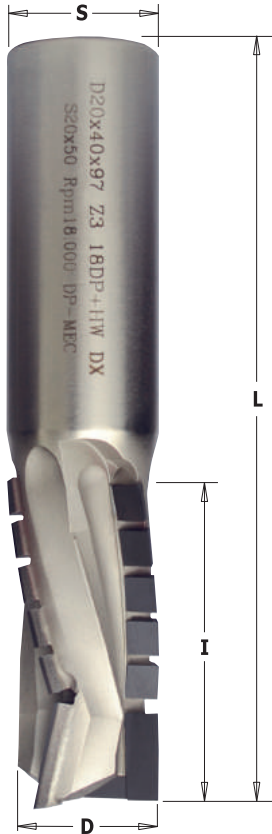

**143**



D mm	I mm	L mm	S mm	Z		ORDER NO. Right-hand rotation
18	25	82	20x50	3 (10 DP+1 HW)	1	<b>143.180.61</b>
18	30	87	20x50	3 (13 DP+1 HW)	1	<b>143.181.61</b>
18	35	92	20x50	3 (15 DP+1 HW)	1	<b>143.182.61</b>
20	25	82	20x50	3 (10 DP+1 HW)	1	<b>143.200.61</b>
20	30	85	20x50	3 (13 DP+1 HW)	1	<b>143.201.61</b>
20	35	92,5	20x50	3 (15 DP+1 HW)	1	<b>143.202.61</b>
20	40	97	20x50	3 (18 DP+1 HW)	1	<b>143.203.61</b>
20	45	102	20x50	3 (21 DP+1 HW)	1	<b>143.204.61</b>
20	50	106,5	20x50	3 (24 DP+1 HW)	1	<b>143.205.61</b>
20	55	111	20x50	3 (27 DP+1 HW)	1	<b>143.206.61</b>
20	60	116,5	20x50	3 (30 DP+1 HW)	1	<b>143.207.61</b>
20	65	121,5	20x50	3 (31 DP+1 HW)	1	<b>143.208.61</b>
22	30	92	25x50	3 (13 DP+1 HW)	1	<b>143.220.61</b>
□ 22	35	97	25x50	3 (15 DP+1 HW)	1	<b>143.221.61</b>
22	40	102	25x50	3 (18 DP+1 HW)	1	<b>143.222.61</b>
□ 22	45	107	25x50	3 (21 DP+1 HW)	1	<b>143.223.61</b>
22	50	112	25x50	3 (24 DP+1 HW)	1	<b>143.224.61</b>
□ 22	55	117	25x50	3 (27 DP+1 HW)	1	<b>143.225.61</b>
22	60	122	25x50	3 (30 DP+1 HW)	1	<b>143.226.61</b>
□ 22	65	127	25x50	3 (31 DP+1 HW)	1	<b>143.227.61</b>
□ 22	70	132	25x50	3 (36 DP+1 HW)	1	<b>143.228.61</b>

□ On request

**TECHNICAL DETAILS:**

- Super strength steel.
- DP cutting edge (H4).
- HW plunging tip for diagonal plunge-cutting (Z-axis tool entrance).
- Resharpenable cutter (max 10/12 times).

**APPLICATION:**

to be used on all CNC routers for jointing, rabbeting, grooving, copying and dividing cuts of raw material, melamine and laminates, MDF, HPL and veneered panels. High performance on pre-and finish-routing.

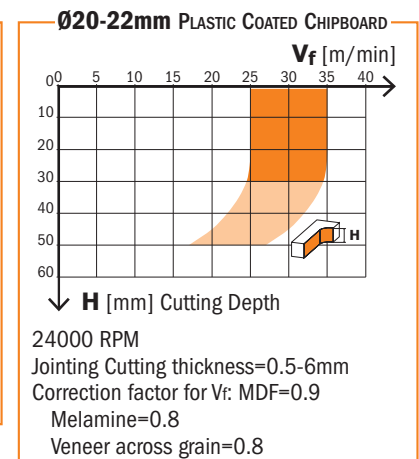
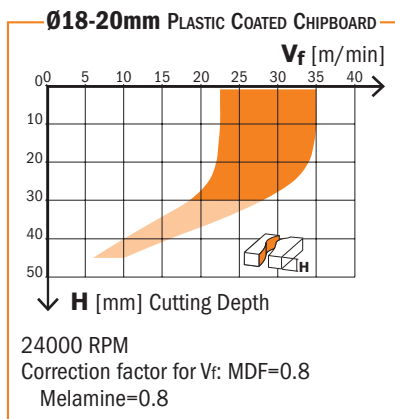

Results shown in this diagram are purely empirical, based merely on informative and hypothetical calculation. Each application may require different parameters in consideration of materials in use and machining conditions. CMT is not responsible for direct, indirect, incidental or consequential damages resulting from any defect, error or failure due to this diagram.

# DP Router Cutters with 40° Shear Angle



DP
Z3+3
Z4+4
RH
40X LONGER LIFE THAN CARBIDE

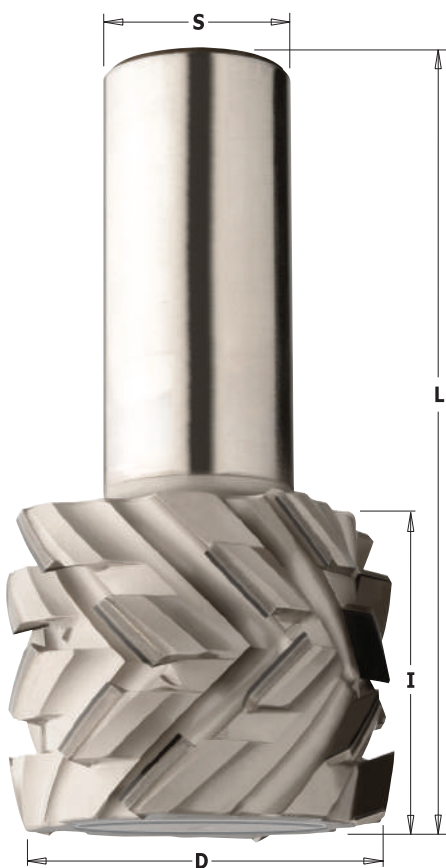

## 145

D mm	I mm	L mm	S mm	Z		ORDER NO. Right-hand rotation
□ 50	23	80	25x55	3+3 (9 DP)	1	<b>145.501.61</b>
□ 50	23	80	25x55	4+4 (12 DP)	1	<b>145.511.61</b>
□ 50	28	85	25x55	3+3 (12 DP)	1	<b>145.502.61</b>
□ 50	28	85	25x55	4+4 (16 DP)	1	<b>145.512.61</b>
□ 50	38	95	25x55	3+3 (18 DP)	1	<b>145.503.61</b>
□ 50	38	95	25x55	4+4 (24 DP)	1	<b>145.513.61</b>

□ On request

### TECHNICAL DETAILS:

- Super strength steel.
- "H4" diamond cutting edges featuring 40° shear angle.
- Resharpenable cutters (max 8-10 times).
- Maximum feed speed 30m/minute.

### APPLICATION:

used on all CNC routers for jointing, rabbeting, grooving, copying and dividing raw material, melamine, laminated, MDF, HPL and veneered panels. High performance routing.





## 174



D mm	I mm	L mm	S mm		ORDER NO. Right-hand rotation
3	10	55	8	10	<b>174.030.11</b>
4	10	55	8	10	<b>174.040.11</b>
5	12	55	8	10	<b>174.050.11</b>
6	14	55	8	10	<b>174.060.11</b>
7	20	55	8	10	<b>174.070.11</b>

### TECHNICAL DETAILS:

- Premium quality HWM.
- 2 radial relief cutting edges [Z2].

# Router Cutters



## 174



D mm	I mm	L mm	S mm		ORDER NO. Right-hand rotation
8	20	55	8	10	<b>174.080.11</b>
8	30	70	8	10	<b>174.081.11</b>
8	40	90	8	10	<b>174.082.11</b>
9	20	55	8	10	<b>174.090.11</b>
10	20	60	8	10	<b>174.100.11</b>
10	30	70	8	10	<b>174.102.11</b>
10	40	90	8	10	<b>174.101.11</b>
11	20	60	8	10	<b>174.110.11</b>
12	20	60	8	10	<b>174.120.11</b>
12	30	70	8	10	<b>174.122.11</b>
12	40	90	8	10	<b>174.121.11</b>
13	20	60	8	10	<b>174.130.11</b>
14	20	60	8	10	<b>174.140.11</b>
14	30	70	8	10	<b>174.142.11</b>
14	40	90	8	10	<b>174.141.11</b>
15	20	60	8	10	<b>174.150.11</b>
16	20	70	8	10	<b>174.160.11</b>
16	30	70	8	10	<b>174.162.11</b>
16	40	90	8	10	<b>174.161.11</b>
18	20	70	8	10	<b>174.180.11</b>
18	30	70	8	10	<b>174.181.11</b>
18	40	80	8	10	<b>174.182.11</b>
19	20	70	8	10	<b>174.190.11</b>
20	20	70	8	10	<b>174.200.11</b>
20	30	70	8	10	<b>174.201.11</b>
20	40	90	8	10	<b>174.202.11</b>
22	20	70	8	10	<b>174.220.11</b>
22	30	70	8	10	<b>174.221.11</b>
22	40	90	8	10	<b>174.222.11</b>
23,5	20	70	8	10	<b>174.235.11</b>
24	20	70	8	10	<b>174.240.11</b>
24	30	70	8	10	<b>174.241.11</b>
24	40	90	8	10	<b>174.242.11</b>
25	20	70	8	10	<b>174.250.11</b>
26	20	70	8	10	<b>174.260.11</b>
26	30	70	8	10	<b>174.261.11</b>
28	20	70	8	10	<b>174.280.11</b>
28	30	70	8	10	<b>174.281.11</b>
29	20	70	8	10	<b>174.290.11</b>
30	20	70	8	10	<b>174.300.11</b>

HW plunge centre tip



### TECHNICAL DETAILS:

- Super strength steel.
- 2 precision ground HW cutting edges and 1 HW plunge centre tip [Z2+1].

### APPLICATION:

used for drilling, grooving or jointing on solid wood and wood composites. Can be used on machining centres, CNC routers and hand-held routers equipped with chucks or adapters.

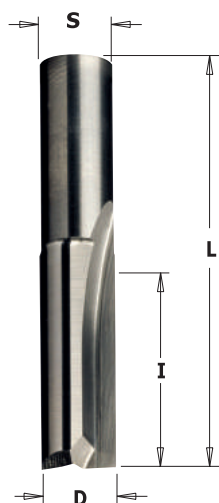

## 112



D mm	I mm	L mm	S mm	PACK QTY.	ORDER NO. Right-hand rotation
3	10	48	9,5	50	<b>112.030.11</b>
4	10	48	9,5	50	<b>112.040.11</b>
5	12	39	9,5	50	<b>112.050.11</b>
6	14	41	9,5	50	<b>112.060.11</b>
7	16	43	9,5	50	<b>112.070.11</b>
8	18	48	9,5	50	<b>112.080.11</b>
8	30	60	9,5	50	<b>112.081.11</b>
9	20	52	9,5	50	<b>112.090.11</b>
10*	22	52	9,5	50	<b>112.100.11</b>
10*	35	65	9,5	50	<b>112.101.11</b>
11*	26	52	9,5	10	<b>112.110.11</b>
12*	26	52	9,5	10	<b>112.120.11</b>

\* Super strength steel  
2 precision ground HW cutting edges [Z2+1]

**TECHNICAL DETAILS:**

- Premium quality HWM.
- 2 radial relief cutting edges [Z2+1].

HW plunge centre tip

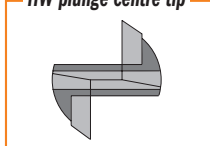

# Router Cutters



## 113



D mm	I mm	L mm	S mm	PACK QTY.	ORDER NO. Right-hand rotation
12	26	52	12	10	<b>113.120.11</b>
12	40	70	12	10	<b>113.121.11</b>
13	26	52	12	10	<b>113.130.11</b>
14	28	56	12	10	<b>113.140.11</b>
14	40	72	12	10	<b>113.141.11</b>
15	32	60	12	10	<b>113.150.11</b>
16	32	60	12	10	<b>113.160.11</b>
16	40	72	12	10	<b>113.161.11</b>
17	35	64	12	10	<b>113.170.11</b>
18	35	64	12	10	<b>113.180.11</b>
19	38	68	12	1	<b>113.190.11</b>
20	38	68	12	1	<b>113.200.11</b>
22	40	72	12	1	<b>113.220.11</b>
24	40	72	12	1	<b>113.240.11</b>
25	40	72	12	1	<b>113.250.11</b>
26	42	74	12	1	<b>113.260.11</b>
28	42	74	12	1	<b>113.280.11</b>
30	42	74	12	1	<b>113.300.11</b>

**TECHNICAL DETAILS:**

- Super strength steel.
- 2 precision ground HW cutting edges and 1 HW plunge centre tip [Z2+1].

**APPLICATION:**

used for grooving, jointing and routing on solid wood, wood composites, plastic materials and laminates.

HW plunge centre tip

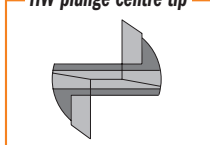



HW plunge centre tip



**TECHNICAL DETAILS:**

- Premium quality HWM.
- 2 radial relief cutting edges [Z2].
- 1 HW [Z1] plunge centre tip.

**APPLICATION:**

for grooving, jointing and routing on solid wood, wood composites, plastic materials and laminates.

## 175



D mm	I mm	L mm	S mm	PACK QTY.	ORDER NO. Right-hand rotation
• 4	10	65	10	50	<b>175.040.11</b>
• 5	12	65	10	50	<b>175.050.11</b>
• 6	14	65	10	50	<b>175.060.11</b>
• 7	17	65	10	50	<b>175.070.11</b>
8	20	65	10	50	<b>175.080.11</b>
10	25	70	10	50	<b>175.100.11</b>
12	25	70	10	10	<b>175.120.11</b>
14	25	70	10	10	<b>175.140.11</b>
15	25	70	10	10	<b>175.150.11</b>
16	25	70	10	10	<b>175.160.11</b>
18	25	70	10	10	<b>175.180.11</b>
20	25	70	10	10	<b>175.200.11</b>
22	25	70	10	10	<b>175.220.11</b>
24	25	70	10	10	<b>175.240.11</b>
25	25	70	10	10	<b>175.250.11</b>
26	25	70	10	10	<b>175.260.11</b>
30	25	70	10	10	<b>175.300.11</b>
35	25	70	10	10	<b>175.350.11</b>

• HWM

## 176



D mm	I mm	L mm	S mm	PACK QTY.	ORDER NO. Right-hand rotation
10	40	87	10	10	<b>176.100.11</b>
12	40	87	10	10	<b>176.120.11</b>
14	40	87	10	10	<b>176.140.11</b>
15	40	87	10	10	<b>176.150.11</b>
16	40	87	10	10	<b>176.160.11</b>
18	40	87	10	10	<b>176.180.11</b>
20	40	87	10	10	<b>176.200.11</b>

## 177



D mm	I mm	L mm	S mm	PACK QTY.	ORDER NO. Right-hand rotation
10	35	90	12	10	<b>177.100.11</b>
12	35	90	12	10	<b>177.120.11</b>
12	50	100	12	10	<b>177.121.11</b>
14	35	90	12	10	<b>177.140.11</b>
16	35	90	12	10	<b>177.160.11</b>
16	60	110	12	10	<b>177.161.11</b>
18	35	90	12	10	<b>177.180.11</b>
18	60	110	12	10	<b>177.181.11</b>
20	35	90	12	10	<b>177.200.11</b>
22	35	90	12	10	<b>177.220.11</b>
24	35	90	12	10	<b>177.240.11</b>
25	35	90	12	10	<b>177.250.11</b>
26	35	90	12	10	<b>177.260.11</b>
28	35	90	12	10	<b>177.280.11</b>
30	35	90	12	10	<b>177.300.11</b>
35	35	90	12	10	<b>177.350.11</b>

**TECHNICAL DETAILS:**

- Super strength steel.
- 2 precision ground HW cutting edges and 1 HW plunge centre tip [Z2+1].

**APPLICATION:**

used for grooving, jointing and general routing operation on solid wood, wood composites, plastics and laminates. Can be used on machining centres, CNC routers and hand-held routers.

HW plunge centre tip





# Straight Router Cutters with Insert Knives



## 653



D mm	I mm	L mm	S mm	SPARE KNIVES		Box	ORDER NO. Right-hand rotation
				Side	Top		
16	28,3	92	20	790.283.12	790.075.00	10	<b>653.661.11</b>
16	48,3	111,5	20	790.483.12	790.075.00	10	<b>653.662.11</b>
18	48,3	111,5	20	790.483.12	790.075.00	10	<b>653.681.11</b>
20	48,3	111,5	20	790.483.12	790.096.00	10	<b>653.701.11</b>

**Spare parts**

790.075.00	7,5x12x1,5mm knife
790.096.00	9,6x12x1,5mm knife
790.283.12	28,3x12x1,5mm knife
790.483.12	48,3x12x1,5mm knife
990.072.00	M3,5x3,5mm Torx screw
990.074.00	M4x3,5mm Torx screw
990.075.00	M4x6mm Torx screw
991.061.00	T15 Torx key

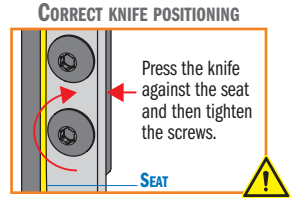

**TECHNICAL DETAILS:**  
 - Super strength steel.  
 - 2 cutting edges [Z1+1].

**APPLICATION:**  
 straight router bit with one replaceable plunging knife and one-sided knife fixed by special Torx screws. The body is precision balanced. For finishing and routing, plunge cutting and grooving in board materials (laminated chipboards, MDF) and hardwood. For use on CNC machining centres.

# Spoilboard Surfacing Router Cutters with Insert Knives



## 663



D mm	I mm	L mm	Z	S mm	Box	ORDER NO. Right-hand rotation	Spare parts	
							Box	Box
<b>new</b> 35	10,5	60	3	8x38	1	<b>663.007.11</b>	790.105.03	990.078.00
38	12	60	3	12x35	1	<b>663.005.11</b>	790.120.03	990.075.00
60	12	80	3	12x50	1	<b>663.004.11</b>	790.120.03	990.075.00
80	12	90	3	20x60	1	<b>663.003.11</b>	790.120.03	990.075.00
<b>new</b> 100	12	90	4	20x50	1	<b>663.006.11</b>	790.120.03	990.075.00

**Spare parts**

991.061.00	T15 Torx key
990.036.00	M8x25mm TE screw (for 663.003.11 and 663.006.11)
990.020.00	Hex nut for threaded arbors M8 (for 663.003.11 and 663.006.11)

**TECHNICAL DETAILS:**  
 - Super strength steel.  
 - 3 cutting edges [Z3].

**APPLICATION:**  
 the new router bit for CNC routers is ideal for fast removal of material over a large surface area leaving an improved finish at the bottom of the cut. Used on soft and hardwood, particle board and MDF. The cutter uses 4-sided inserts in super micrograin carbide.

A cost effective solution compared to brazed router bits and solid carbide spiral bits.

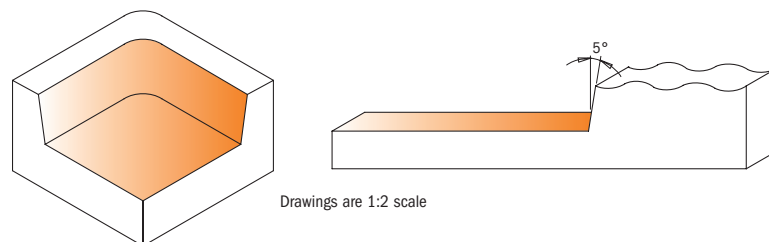
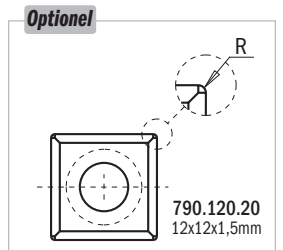

# Xtreme Plunge CNC Cutters with Insert Knives

new

**CMT ORANGE TOOLS**



## 653 XTREME

D mm	I mm	L mm	S mm	SPARE KNIVES		Box	ORDER NO. Right-hand rotation
				Side	Top		
40	29,5	100	20	790.295.12	790.120.00	10	<b>653.001.11</b>

**Spare parts**

790.120.00	12x12x1,5mm knife
790.295.12	29,5x12x1,5mm knife
990.075.00	M4x6mm Torx screw
991.061.00	T15 Torx key
990.036.00	M8x25mm TE screw
990.020.00	Hex nut for threaded arbors M8

**TECHNICAL DETAILS:**  
 - Super strength steel.  
 - 2 cutting edges [Z2+2].

**APPLICATION:**  
 The new CNC cutter is designed with 2 plunging knives and two-sided knives fixed by special Torx screws. It is ideal for direct plunge into the material and fast removal over a large surface area leaving an improved finish at the bottom of the cut.  
 Use on soft and hardwood, particle board, melamine and MDF.  
 For use on CNC machining centres only.

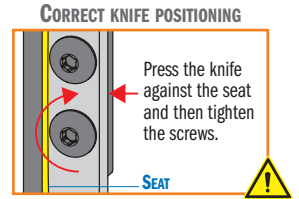

# Universal Profile Cutter for CNC Machines



## 663.301



D mm	I mm	L mm	S mm	Box	ORDER NO. Right-hand rotation

**Spare parts**

692.999.01	38x15x16mm wedge for cutter
990.068.00	M5x5mm TCEI screw
991.064.00	Hex key 4mm

**TECHNICAL DETAILS:**  
 - Super Strength steel.  
 - 2 cutting edges [Z2]  
 for knives 40x4mm and 50x4mm.

**APPLICATION:**  
 for universal profiling of solid wood on CNC router machines. For cutting width 40mm and 50mm (serie 690). Profile knives may only be ordered and used in pairs. For router machines with mechanical feed.

**USEFUL TIPS:** for enhanced safety, when using 50mm knives, it is recommended to carry out the cut in several passes.

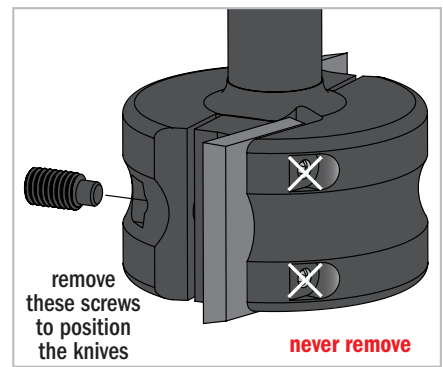

### TO BE USED WITH SP KNIVES SERIES 690 (SEE PAGE 116~129)

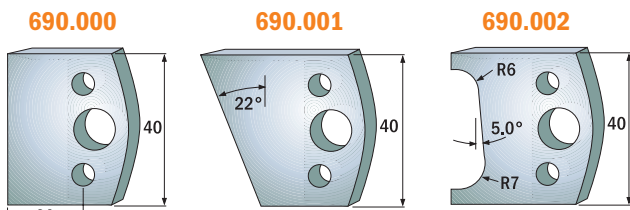

Profile knives cutting length=40mm (serie 690)

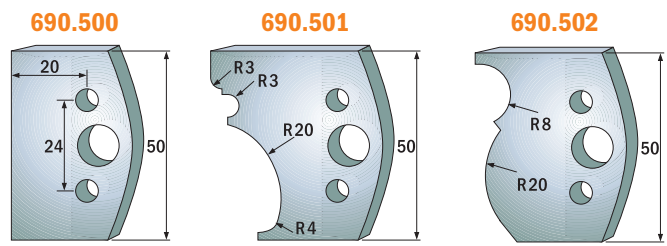

Profile knives cutting length=50mm (serie 690.5)

# Adjustable Chamfering CNC Cutter

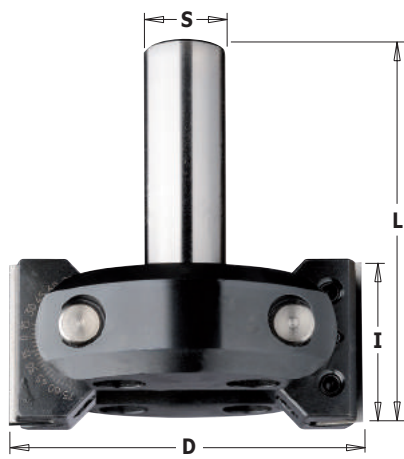

## 663.201

INSERT CARBIDE MEC PACK QTY. 10 PCS Z2 RH 2X LONGER LIFE

D mm	D_Max 45° mm	I mm	A	L mm	S mm	ORDER NO.
85	102	39,5	0°-45° - 0°+90°	92	20	663.201.11

- Spare parts**
- 790.395.12 39,5x12x1,5mm knife
  - 663.999.01 38x6x12mm wedge
  - 990.087.00 M6x8mm STEI screw (4x2mm threaded pin)
  - 991.067.00 3mm hex key
  - 663.999.02 Kit with 2 wedges and 1 screw for blocking rotation
  - 990.099.00 M8x25mm TCEI screw
  - 990.023.00 M8 (4mm) nut
  - 991.081.00 4mm "T" hex key

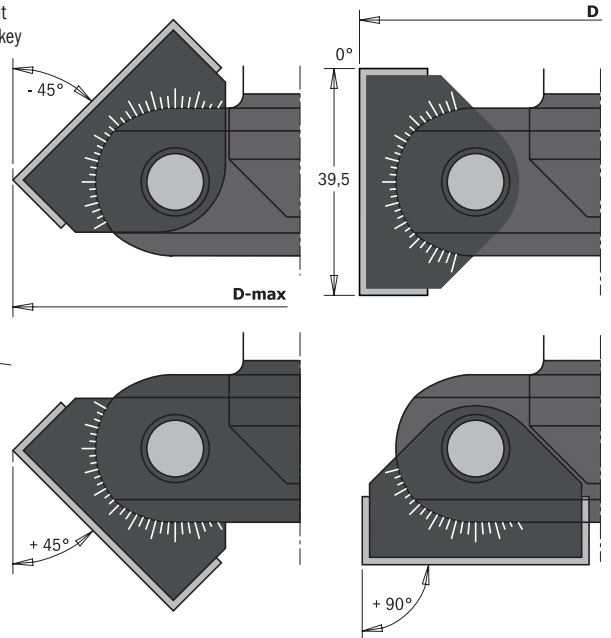

**TECHNICAL DETAILS:**

- Tool body in steel
- 2 reversible HWM knives 39,5x12x1,5mm [Z2]
- Peripheral cutting on both sides
- Adjustable swivelling blade (Rotates at 7,5° intervals; Precision = 7,5°)
- Swivelling range 0-45° towards top, and 0-90° towards bottom

**APPLICATION:**

for jointing, rebating and chamfering of solid wood and wooden boards. Suitable for CNC router machines and stationary router machine with manual or mechanical feed.

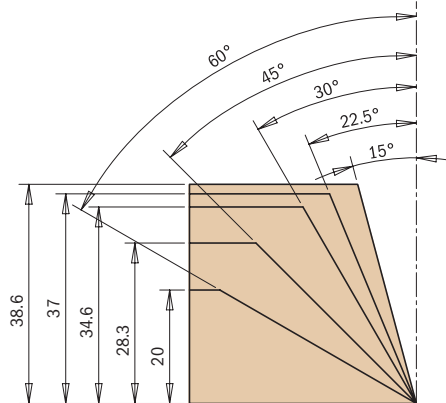

# V-Groove - Folding - Signmaking CNC Router Cutters with Insert Knives

new



## 663.1

INSERT CARBIDE MEC Z1 Z2 RH 2X LONGER LIFE

D mm	I mm	L mm	A	S mm	Z	ORDER NO.	Spare parts
33	40	125	45°	20	1	663.103.11	790.580.01
44	38	115	60°	20	1	663.102.11	790.580.01
52	25	100	91°	20	1	663.101.11	790.360.01
60	21	95	110°	20	1	663.110.11	790.360.01
87	24	95	120°	20	2	663.120.11	790.496.01
91	20	95	130°	20	2	663.130.11	790.496.01
96,5	12,4	95	150°	20	2	663.150.11	790.496.01

- Spare parts**
- 990.073.00 M3,5x5x7,2mm Torx T15 screw (for 790.580.01)
  - 990.075.00 M4x6x8,2mm Torx T15 screw
  - 991.061.00 T15 Torx key
  - 990.036.00 M8x25mm TE screw
  - 990.020.00 Hex nut for threaded arbors M8

- Optional**
- S790.360.03 36x12x1,5mm HW-SMG replaceable knife (4 cutting edges 35°)

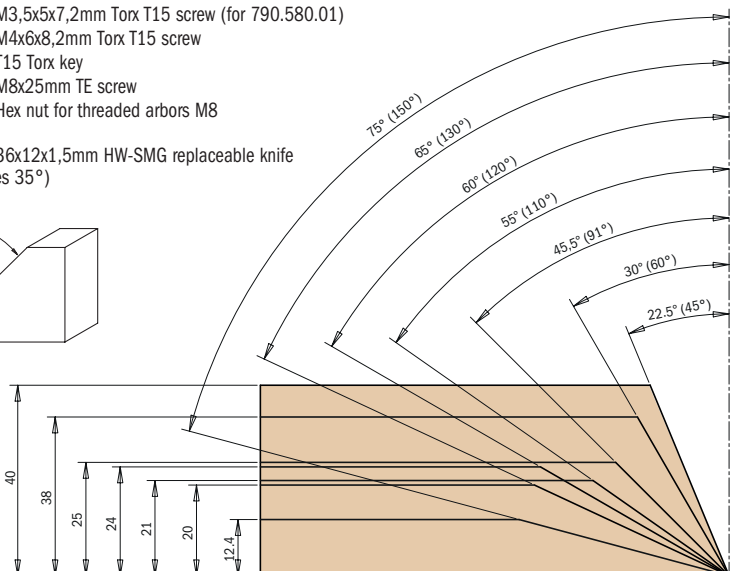
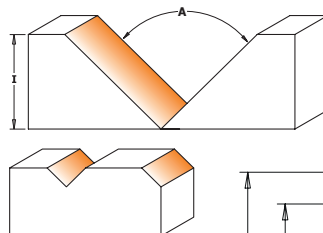
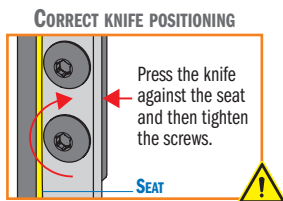

**APPLICATION:**

this innovative CNC router bit offers you an endless range of possibilities for V-Groove, miter folds, signmaking, lettering and chamfer edges. The tool mounts a high grade HWM reversible knife ideal for general purpose, chipboard and plywood, but a higher quality is available for laminated and MDF material.



# Complete Set for Decorating on MDF



## 616.000.01

This unique system includes a tool body with 22 profile knives designed for multiple applications on your CNC routers. Ideal for MDF, laminates, veneers, plastic, wood and solid surface materials.

**TECHNICAL DETAILS:**

Knives 20x20x2mm.

We recommend re-sharpening the knives on profile cutting edge.

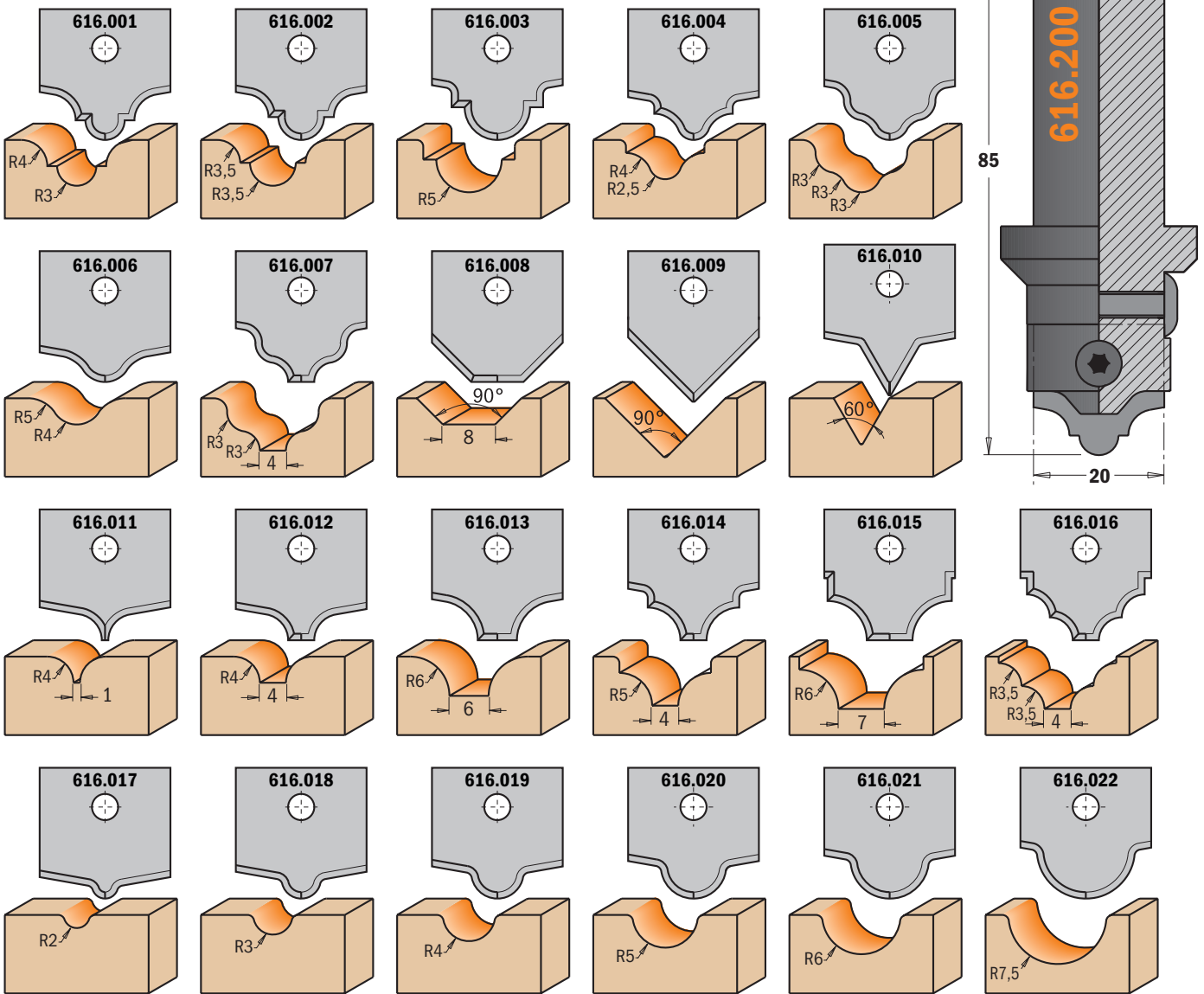

Drawings are 1:1 scale

DESCRIPTION	S mm		ORDER NO. Right-hand rotation			
Complete Set for Decorating on MDF	20	10	<b>616.000.01</b>	616.200	990.077.00	991.061.00
Router cutter body with shank Ø20mm (insert knives not included)	20	10	<b>616.200</b>		990.077.00	991.061.00
Router cutter body with shank Ø12mm (insert knives not included)	12	10	<b>616.120</b>		990.077.00	991.061.00

**REMARK:** tool body and insert knives can be sold individually.



**615.004.01**

Open some new doors with CMT. Our 4-piece set includes the most popular profile to make MDF panel doors for kitchens and bathrooms. Each bit is made from bar stock steel and is equipped with 5 different profile knives allowing enormous possibilities for easy and economical construction. The highest materials, the lowest tolerance in balancing and the precision in the sharpening of the knives let you obtain a smooth finish on your CNC machine.

- Spare parts**
- 991.061.00 T15 Tork key
  - 990.073.00 M3,5x5mm Torx screw
  - 990.075.00 M4x6mm Torx screw
  - 990.077.00 M3,5x7mm Torx screw

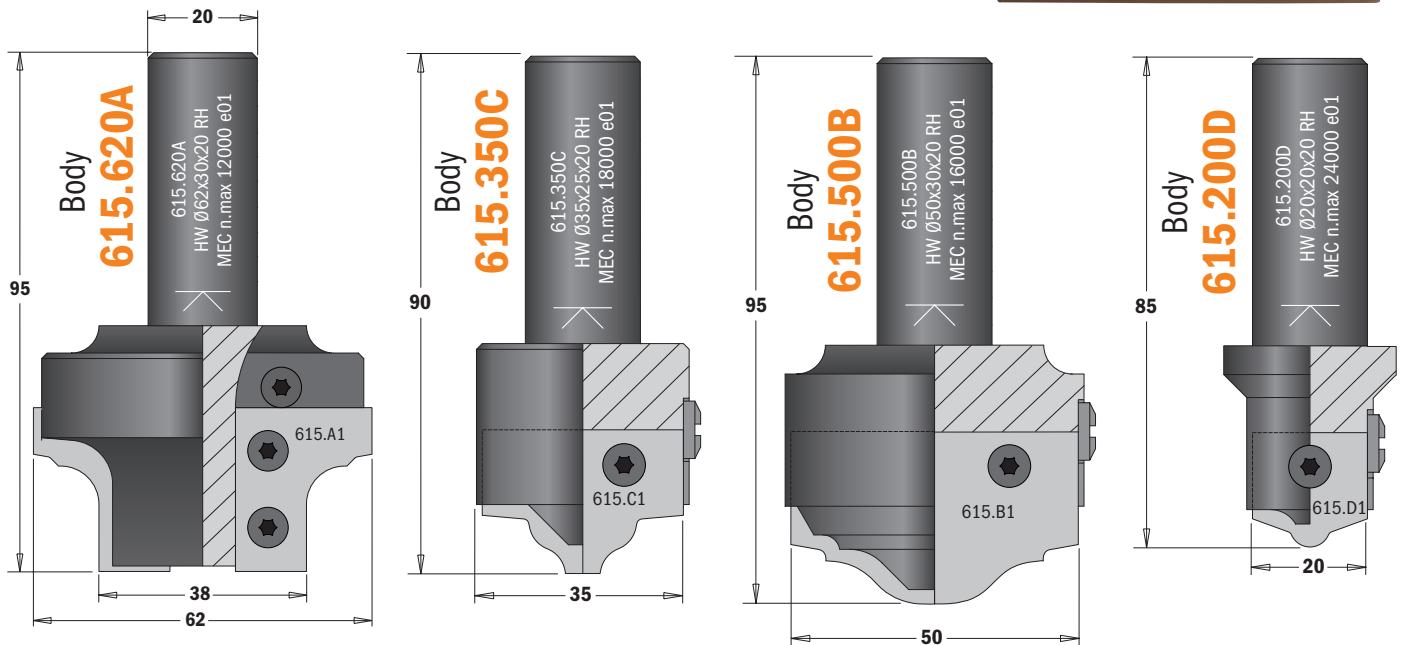

**Standard** Profile No. 1

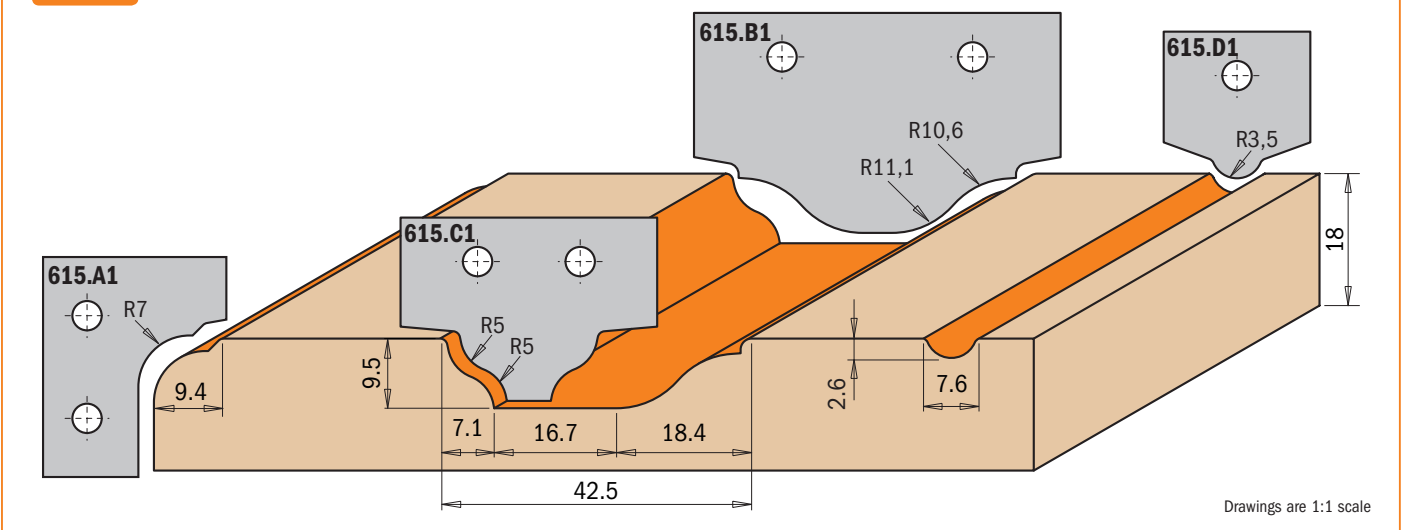

Drawings are 1:1 scale

DESCRIPTION	S mm	ORDER NO.
Complete Set for MDF Doors (Profile no. 1)	20	Right-hand rotation <b>615.004.01</b>

Optional

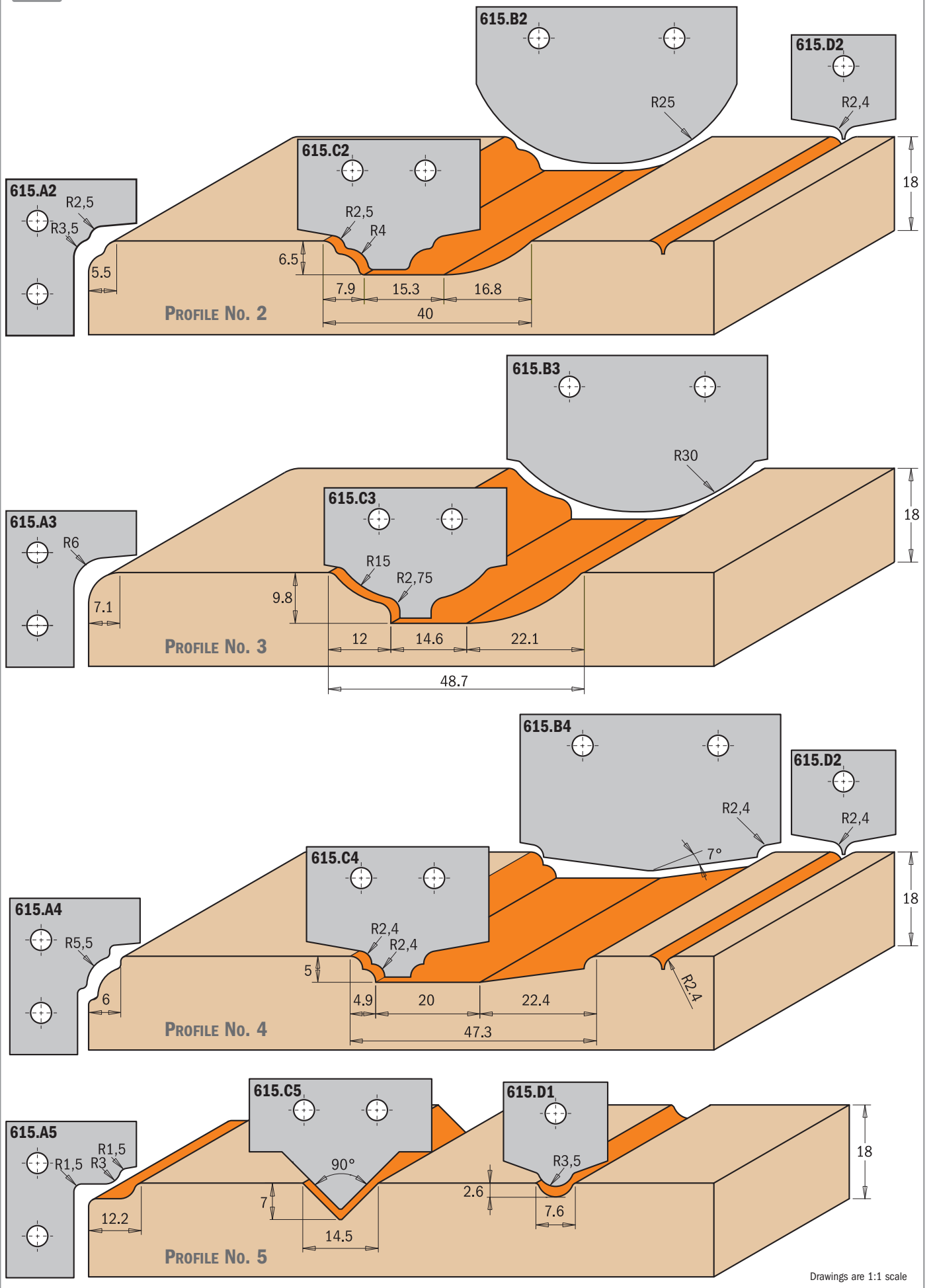

Drawings are 1:1 scale



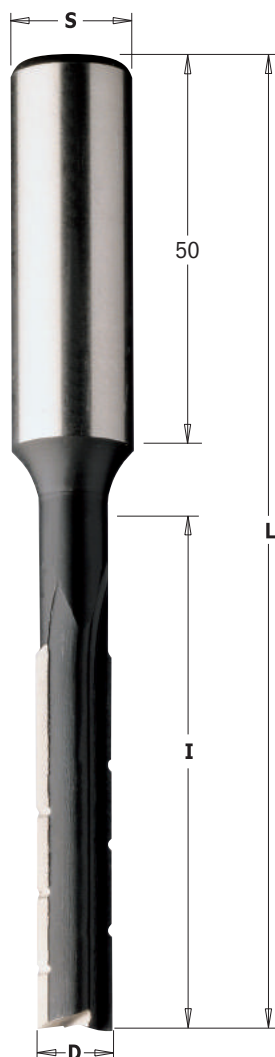

## 102

D mm	I mm	L mm	S mm		ORDER NO. Right-hand rotation	ORDER NO. Left-hand rotation
6	50	105	16	10	102.060.31	102.060.32
7	55	110	16	10	102.070.31	102.070.32
8	60	115	16	10	102.080.31	102.080.32
9	65	120	16	10	102.090.31	102.090.32
10	70	125	16	10	102.100.31	102.100.32
11	75	130	16	10	102.110.31	102.110.32
12	80	135	16	10	102.120.31	102.120.32
13	85	140	16	10	102.130.31	102.130.32
14	90	145	16	10	102.140.31	102.140.32
15	95	150	16	10	102.150.31	102.150.32
16	100	155	16	10	102.160.31	102.160.32
17	105	160	16	10	102.170.31	102.170.32
18	110	165	16	10	102.180.31	102.180.32
19	115	170	16	10	102.190.31	102.190.32
20	120	175	16	10	102.200.31	102.200.32
22	125	180	16	10	102.220.31	102.220.32
24	125	180	16	10	102.240.31	102.240.32

## 172

D mm	I mm	L mm	S mm		ORDER NO. Right-hand rotation	ORDER NO. Left-hand rotation
6	50	105	13	10	172.060.31	172.060.32
7	55	110	13	10	172.070.31	172.070.32
8	60	115	13	10	172.080.31	172.080.32
9	65	120	13	10	172.090.31	172.090.32
10	70	125	13	10	172.100.31	172.100.32
11	75	130	13	10	172.110.31	172.110.32
12	80	135	13	10	172.120.31	172.120.32
13	85	140	13	10	172.130.31	172.130.32
14	90	145	13	10	172.140.31	172.140.32
15	95	150	13	10	172.150.31	172.150.32
16	100	155	13	10	172.160.31	172.160.32
18	110	165	13	10	172.180.31	172.180.32
20	120	175	13	10	172.200.31	172.200.32

### TECHNICAL DETAILS:

- Long-lasting cutting performance.
- 2 HL precision ground straight cutting edges with chip-breaker teeth [Z2R].

### APPLICATION:

for cutting mortise slots in soft and hardwood. Used on machining centres equipped with chucks.

### MACHINING DEEP SLOTS GUIDE

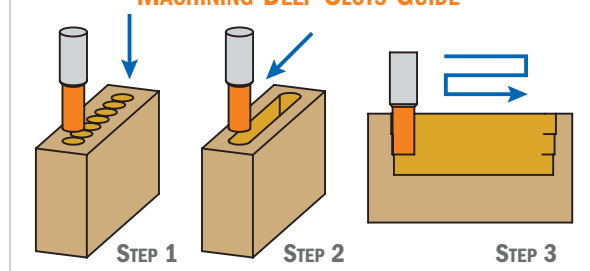

## 6-Piece Mortising Bit Sets

### 102-172



Ideal for heavy mortise jobs. Made of super strength high speed steel and available in left-hand or right-hand rotation. Safely packaged in a hardwood and glass box for protection, these sets are economical and a perfect addition to any workshop.



S mm	D mm		ORDER NO. Right-hand rotation	ORDER NO. Left-hand rotation
16	6-8-10-12-14-16	1	102.001.00	102.001.10
13	6-8-10-12-14-16	1	172.001.00	172.001.10

# Twisted Slot Mortising Bits with Chip-Breaker

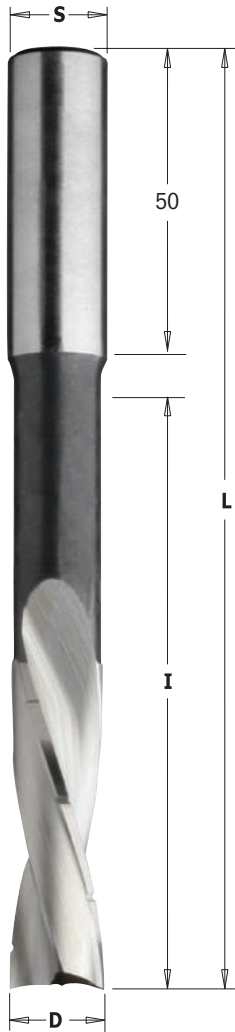

## 161



D mm	I mm	L mm	S mm		ORDER NO. Right-hand rotation	ORDER NO. Left-hand rotation
6	60	120	16	10	<b>161.060.31</b>	<b>161.060.32</b>
8	70	130	16	10	<b>161.080.31</b>	<b>161.080.32</b>
10	80	140	16	10	<b>161.100.31</b>	<b>161.100.32</b>
12	90	150	16	10	<b>161.120.31</b>	<b>161.120.32</b>
14	100	160	16	10	<b>161.140.31</b>	<b>161.140.32</b>
16	110	170	16	10	<b>161.160.31</b>	<b>161.160.32</b>

## 160



D mm	I mm	L mm	S mm		ORDER NO. Right-hand rotation	ORDER NO. Left-hand rotation
6	60	120	13	10	<b>160.060.31</b>	<b>160.060.32</b>
8	70	130	13	10	<b>160.080.31</b>	<b>160.080.32</b>
10	80	140	13	10	<b>160.100.31</b>	<b>160.100.32</b>
12	90	150	13	10	<b>160.120.31</b>	<b>160.120.32</b>
14	100	160	13	10	<b>160.140.31</b>	<b>160.140.32</b>
16	110	170	13	10	<b>160.160.31</b>	<b>160.160.32</b>

### TECHNICAL DETAILS:

- Long-lasting cutting performance.
- 2 HSS precision ground twisted cutting edges with chip-breaker teeth [Z2R].

### APPLICATION:

for cutting mortise slots in soft and hardwood. Used on machining centres equipped with chucks. RPM 3000~5000

### MACHINING DEEP SLOTS GUIDE

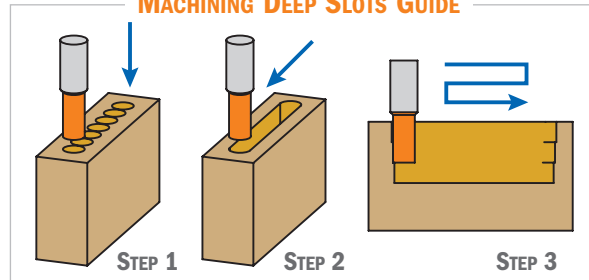

## 6-Piece Mortising Bit Sets

### 160-161



Ideal for heavy mortise jobs. Made of super strength high speed steel and available in left-hand or right-hand rotation. Safely packaged in a hardwood and glass box for protection, these sets are economical and a perfect addition to any workshop.



S mm	D mm		ORDER NO. Right-hand rotation	ORDER NO. Left-hand rotation
16	6-8-10-12-14-16	1	<b>161.001.00</b>	<b>161.001.10</b>
13	6-8-10-12-14-16	1	<b>160.001.00</b>	<b>160.001.10</b>

## Slot & Mortise Boring Bits



**164**



D mm	L mm	S mm		ORDER NO. Right-hand rotation
18	100	M12x1	1	<b>164.180.11</b>
20	100	M12x1	1	<b>164.200.11</b>
22	100	M12x1	1	<b>164.220.11</b>

**TECHNICAL DETAILS:**

- Super strength steel.
- HW cutting head with precision balanced centre point.
- 2 HW precision ground cutting edges [Z2].
- 2 negatively ground spurs [V2].

**APPLICATION:**

used for drilling blind holes in solid wood, wood composites, plastic and laminated materials. Used on slot and mortise machines equipped with chucks.

## Slot & Mortise Boring Bits

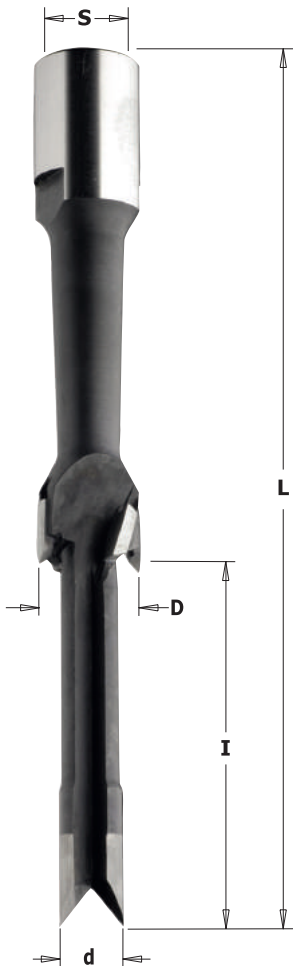

**166-167**



d mm	D mm	I mm	L mm	S mm		ORDER NO. Right-hand rotation
11	22	62	155	M12x1	1	<b>166.220.11</b>
12	19	62	155	M12x1	1	<b>167.190.11</b>

**TECHNICAL DETAILS:**

- Super strength steel.
- 2 HW precision ground cutting edges [Z2].
- 2 negatively ground spurs [V2].

**APPLICATION:**

used for drilling and cutting mortise slots in solid wood, wood composites, plastic and laminated materials.



# Slot & Mortise Boring Bits



## 163



D mm	L mm	S mm		ORDER NO. Right-hand rotation
12	100	M12x1	1	<b>163.120.11</b>
14	100	M12x1	1	<b>163.140.11</b>
16	100	M12x1	1	<b>163.160.11</b>

**TECHNICAL DETAILS:**

- Super strength steel.
- 2 HW precision ground cutting edges [Z2].

**APPLICATION:**

used for cutting mortises and slots in solid wood and wood composites. Assembled in chucks.

# Carbide Spiral Slot Mortising Bits with Chip-Breaker

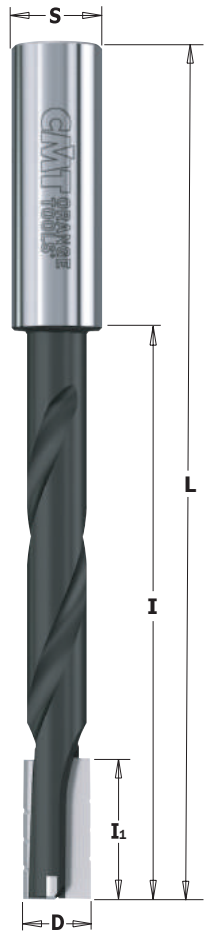

## 161



D mm	I <sub>1</sub> mm	I mm	L mm	S mm		ORDER NO. Right-hand rotation	ORDER NO. Left-hand rotation
12	25	75	150	16x50	10	<b>161.120.11</b>	<b>161.120.12</b>
16	25	95	170	16x50	10	<b>161.160.11</b>	<b>161.160.12</b>

**TECHNICAL DETAILS:**

- Long-lasting cutting performance.
- Super strength steel.
- 2 precision ground HW cutting edges with chip-breaker teeth and 1 HW plunge centre tip [Z2+1].

**APPLICATION:**

for cutting mortise slots in soft and hardwood. Used on machining centres equipped with chucks. RPM 3000~5000

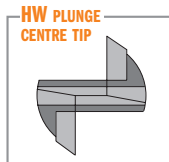

**MACHINING DEEP SLOTS GUIDE**

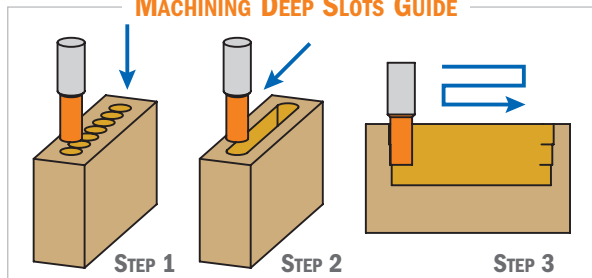

## Reciprocating Slot Mortising Bits



### 103



D mm	I mm	L mm	S mm		ORDER NO. Right-hand & Left-hand rotation
6	45	100	16	1	<b>103.060.30</b>
7	45	100	16	1	<b>103.070.30</b>
8	45	100	16	1	<b>103.080.30</b>
9	45	100	16	1	<b>103.090.30</b>
10	55	110	16	1	<b>103.100.30</b>
11	55	110	16	1	<b>103.110.30</b>
12	55	110	16	1	<b>103.120.30</b>
13	55	110	16	1	<b>103.130.30</b>
14	55	110	16	1	<b>103.140.30</b>
15	55	110	16	1	<b>103.150.30</b>
16	55	110	16	1	<b>103.160.30</b>

**TECHNICAL DETAILS:**

- Long-lasting cutter performance.
- 2 HL precision ground cutting edges [Z2].

**APPLICATION:**

used for cutting mortise slots in soft and hardwood.  
Used on machining centres equipped with chucks.

## Reciprocating Slot Mortising Bits

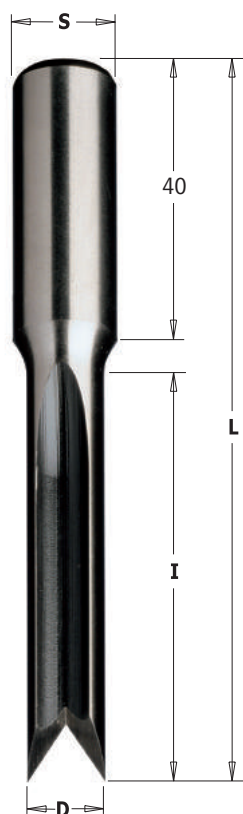

### 179



D mm	I mm	L mm	S mm		ORDER NO. Right-hand & Left-hand rotation
6	45	90	13	1	<b>179.060.50</b>
7	50	95	13	1	<b>179.070.50</b>
8	50	95	13	1	<b>179.080.50</b>
9	55	100	13	1	<b>179.090.50</b>
10	60	105	13	1	<b>179.100.50</b>
11	65	110	13	1	<b>179.110.50</b>
12	70	115	13	1	<b>179.120.50</b>
13	75	120	13	1	<b>179.130.50</b>

**TECHNICAL DETAILS:**

- Long-lasting cutter performance.
- 2 HSS precision ground cutting edges [Z2].

**APPLICATION:**

used for cutting mortise slots in soft and hardwood.  
Used on machining centres equipped with chucks.

# Reciprocating Slot Mortising Bits

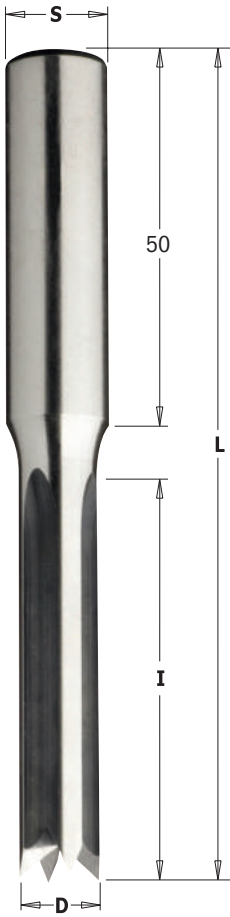

## 104



D mm	I mm	L mm	S mm		ORDER NO. Right-hand & Left-hand rotation
6	45	100	13	1	<b>104.060.30</b>
7	45	100	13	1	<b>104.070.30</b>
8	45	100	13	1	<b>104.080.30</b>
9	45	100	13	1	<b>104.090.30</b>
10	55	110	13	1	<b>104.100.30</b>
11	55	110	13	1	<b>104.110.30</b>
12	55	110	13	1	<b>104.120.30</b>
13	55	110	13	1	<b>104.130.30</b>
14	55	110	13	1	<b>104.140.30</b>
15	55	110	13	1	<b>104.150.30</b>
16	55	110	13	1	<b>104.160.30</b>

**TECHNICAL DETAILS:**

- Long-lasting cutting performance.
- 4 HL precision ground cutting edges [Z4].

**APPLICATION:**

used for cutting mortise slots in soft and hardwood. Used on machining centres equipped with chucks.

# Reciprocating Slot Mortising Bits

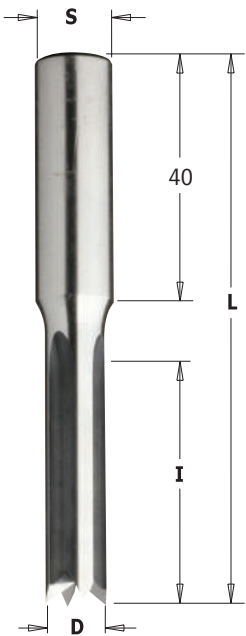

## 105



D mm	I mm	L mm	S mm		ORDER NO. Right-hand & Left-hand rotation
6	28	73	10	1	<b>105.060.30</b>
7	28	73	10	1	<b>105.070.30</b>
8	28	73	10	1	<b>105.080.30</b>
9	28	73	10	1	<b>105.090.30</b>
10	28	73	10	1	<b>105.100.30</b>
11	28	73	10	1	<b>105.110.30</b>
12	28	73	10	1	<b>105.120.30</b>
13	28	73	10	1	<b>105.130.30</b>
14	28	73	10	1	<b>105.140.30</b>
15	28	73	10	1	<b>105.150.30</b>
16	28	73	10	1	<b>105.160.30</b>

**TECHNICAL DETAILS:**

- Long-lasting cutting performance.
- 4 HL precision ground cutting edges [Z4].

**APPLICATION:**

used for cutting mortise slots in soft and hardwood. Used on machining centres equipped with chucks.



## Reciprocating Slot Mortising Bits

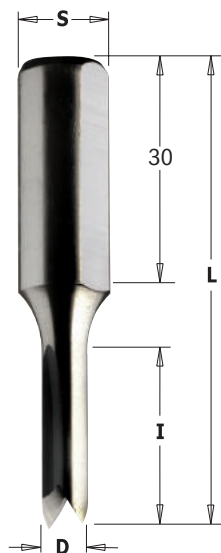

### 106



D mm	I mm	L mm	S mm	Z		ORDER NO. Right-hand & Left-hand rotation
6	25	60	12	2	1	<b>106.060.30</b>
7	25	60	12	2	1	<b>106.070.30</b>
8	25	60	12	2	1	<b>106.080.30</b>
9	25	60	12	2	1	<b>106.090.30</b>
10	25	60	12	4	1	<b>106.100.30</b>
11	25	60	12	4	1	<b>106.110.30</b>
12	25	60	12	4	1	<b>106.120.30</b>
13	25	60	12	4	1	<b>106.130.30</b>
14	25	60	12	4	1	<b>106.140.30</b>
15	25	60	12	4	1	<b>106.150.30</b>

**TECHNICAL DETAILS:**

- Long-lasting cutter performance.
- 2 or 4 HL precision ground cutting edges [Z2-Z4].
- Parallel shank with driving flat.

## Slot Mortising Bits

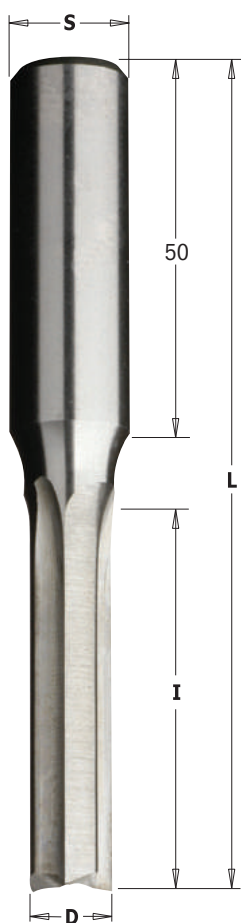

### 107



D mm	I mm	L mm	S mm		ORDER NO. Right-hand rotation	ORDER NO. Left-hand rotation
6	55	110	16	1	<b>107.060.31</b>	<b>107.060.32</b>
8	55	110	16	1	<b>107.080.31</b>	<b>107.080.32</b>
10	55	110	16	1	<b>107.100.31</b>	<b>107.100.32</b>
12	55	110	16	1	<b>107.120.31</b>	<b>107.120.32</b>
14	60	115	16	1	<b>107.140.31</b>	<b>107.140.32</b>
16	60	115	16	1	<b>107.160.31</b>	<b>107.160.32</b>
18	60	115	16	1	<b>107.180.31</b>	<b>107.180.32</b>
20	60	115	16	1	<b>107.200.31</b>	<b>107.200.32</b>

**TECHNICAL DETAILS:**

- Long-lasting cutter performance.
- 3 HL precision ground cutting edges [Z3].

**APPLICATION:**

used for cutting mortise slots in soft and hardwood.  
Used in machining centres equipped with chucks.

# INDUSTRIAL DOWEL DRILLS

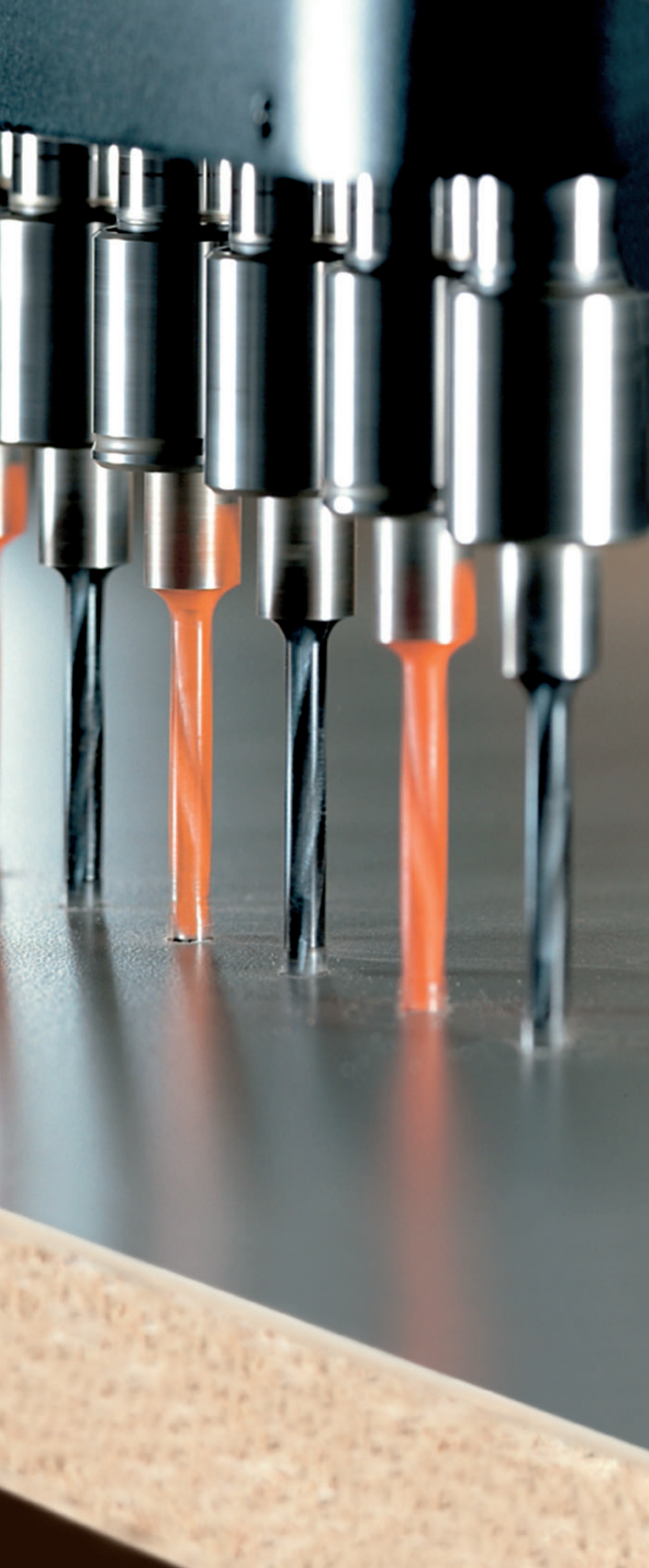

PRODUCTS	PAGE
Adapters	292~294
XTreme Solid Carbide Boring Bits	295~297
XTreme Boring Bits	298~299
Solid Carbide Twist Drills	300~301
2 Flute Dowel Drills	302~303
4 Flute Dowel Drills	304~306
Dowel Drills with Countersink	307
Through Hole Dowel Drills	308~309
Countersinks	310
Hinge Boring Bits	311~313
Dowel Drills with Threaded Shank	314~316



# Adapters

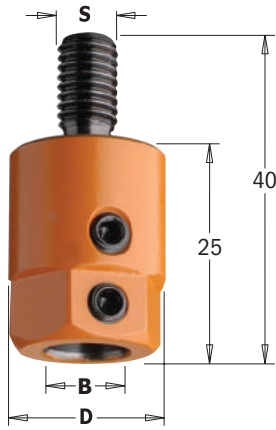

## 301

**RH LH**

B mm	D mm	S mm		ORDER NO. Right-hand rotation	ORDER NO. Left-hand rotation
8	16	M8	10	<b>301.080.01</b>	<b>301.080.02</b>
10	19,5	M8	10	<b>301.000.01</b>	<b>301.000.02</b>

**FOR USE ON THE FOLLOWING MACHINES:**  
Nottmeyer (older models).

Spare parts

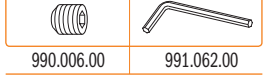

## 302

**RH LH**

B mm	D mm	S mm		ORDER NO. Right-hand rotation	ORDER NO. Left-hand rotation
8	16	M10	10	<b>302.080.01</b>	<b>302.080.02</b>
10	19,5	M10	10	<b>302.000.01</b>	<b>302.000.02</b>

**FOR USE ON THE FOLLOWING MACHINES:**  
Ayen, Holzma, Knoevenagel, Mayer, Torwegge.

Spare parts

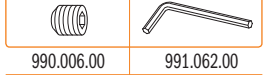

## 303

**RH LH**

B mm	D mm	S mm		ORDER NO. Right-hand rotation	ORDER NO. Left-hand rotation
8	16	M10/30°	10	<b>303.080.01</b>	<b>303.080.02</b>
10	19,5	M10/30°	10	<b>303.000.01</b>	<b>303.000.02</b>

**FOR USE ON THE FOLLOWING MACHINES:**  
Alberti (older models).  
Balestrini, Bilek, Busellato (older models).  
Schleicher, Vitap (older models).

Spare parts

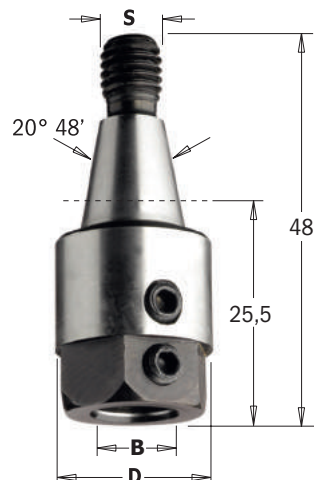
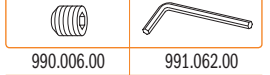

## 304

**RH LH**

B mm	D mm	S mm		ORDER NO. Right-hand rotation	ORDER NO. Left-hand rotation
8	16	M8/20° 48'	10	<b>304.080.01</b>	<b>304.080.02</b>
10	19,5	M8/20° 48'	10	<b>304.000.01</b>	<b>304.000.02</b>

**FOR USE ON THE FOLLOWING MACHINES:**  
Balestrini, Bilek.

Spare parts



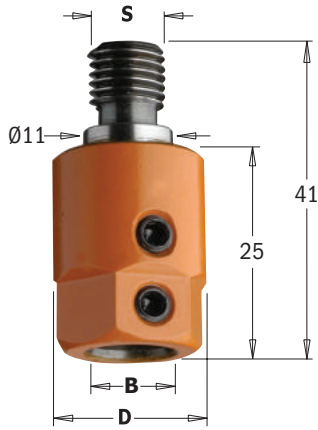

**305**

**RH LH**

B mm	D mm	S mm		ORDER NO. Right-hand rotation	ORDER NO. Left-hand rotation
8	16	M10/11	10	<b>305.080.01</b>	<b>305.080.02</b>
10	19,5	M10/11	10	<b>305.000.01</b>	<b>305.000.02</b>

**FOR USE ON THE FOLLOWING MACHINES:**  
 Biesse (older models).  
 Masterwood (Zangheri & Boschetti).  
 Morbidelli, Torwegge, Vitap (new design).  
 Weeke.

Spare parts

990.006.00	991.062.00

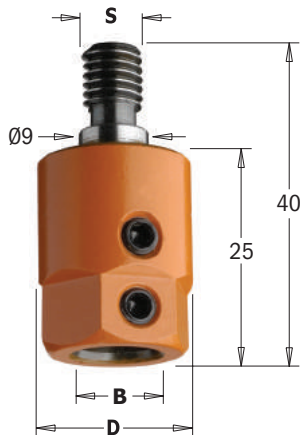

**358**

**RH LH**

B mm	D mm	S mm		ORDER NO. Right-hand rotation	ORDER NO. Left-hand rotation
8	16	M8/9	10	<b>358.080.01</b>	<b>358.080.02</b>
10	19,5	M8/9	10	<b>358.000.01</b>	<b>358.000.02</b>

**FOR USE ON THE FOLLOWING MACHINES:**  
 Masterwood (Zangheri & Boschetti).  
 Morbidelli, Nottmeyer (new design).

Spare parts

990.006.00	991.062.00



**359**

**RH LH**

B mm	D mm	S mm		ORDER NO. Right-hand rotation	ORDER NO. Left-hand rotation
10	19,5	M10	10	<b>359.000.01</b>	<b>359.000.02</b>

**FOR USE ON THE FOLLOWING MACHINES:**  
 Scheer.

Spare parts

990.006.00	991.062.00



**360.001**

**RH LH**

B mm	d mm	D mm		ORDER NO. Right-hand rotation	ORDER NO. Left-hand rotation
10	20	15	10	<b>360.001.01</b>	<b>360.001.02</b>

**FOR USE ON THE FOLLOWING MACHINES:**  
 For Biesse machines with quick drill change attachment.

Spare parts

990.007.00	991.067.00





### 360.101

LH RH

<b>B</b> mm	<b>d</b> mm	<b>D</b> mm		<b>ORDER NO.</b> Right-hand & Left-hand rotation
10	17,5	18	10	<b>360.101.00</b>

**FOR USE ON THE FOLLOWING MACHINES:**  
Vitap.

<b>Spare parts</b>	
990.015.00	991.062.00



### 360.201

LH RH

<b>B</b> mm	<b>d</b> mm	<b>D</b> mm		<b>ORDER NO.</b> Right-hand & Left-hand rotation
10	19,5	20	10	<b>360.201.00</b>

**FOR USE ON THE FOLLOWING MACHINES:**  
Morbidelli.

<b>Spare parts</b>	
990.009.00	991.067.00



### 360.301

LH RH

<b>B</b> mm	<b>d</b> mm	<b>D</b> mm		<b>ORDER NO.</b> Right-hand & Left-hand rotation
10	19,5	20	10	<b>360.301.00</b>

**FOR USE ON THE FOLLOWING MACHINES:**  
Masterwood, Maggi, Griggio.

<b>Spare parts</b>	
990.015.00	991.062.00



### 360.401

LH RH

<b>B</b> mm	<b>d</b> mm	<b>D</b> mm		<b>ORDER NO.</b> Right-hand & Left-hand rotation
10	20	17	10	<b>360.401.00</b>

**FOR USE ON THE FOLLOWING MACHINES:**  
Weeke.

<b>Spare parts</b>	
990.009.00	991.067.00

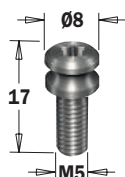

### 990.088

LH RH

<b>DESCRIPTION</b>		<b>ORDER NO.</b> Right-hand & Left-hand rotation
Retaining screw for Weeke machines	10	<b>990.088.00</b>

LINE	XTREME FLAT	XTREME	XTREME	INDUSTRIAL
PERFORMANCE	SUPERIOR ★★★★★	SUPERIOR ★★★★★	EXCELLENT ★★★★★	VERY GOOD ★★★
BIT				
DESCRIPTION	Designed for heavy duty drilling in Large-Scale Industrial Manufacturing ensuring high impact resistance and greater durability.	Designed for heavy duty drilling in Large-Scale Industrial Manufacturing ensuring high impact resistance and greater durability.	Designed for heavy-duty to medium-duty drilling in large-scale to medium-scale industrial manufacturing ensuring high impact resistance and greater durability.	Designed for medium-duty to light-duty drilling in medium-scale to small-scale industrial manufacturing ensuring rigorous impact resistance and good durability.
USER	LARGE-SCALE INDUSTRIAL MANUFACTURING	LARGE-SCALE INDUSTRIAL MANUFACTURING	LARGE-SCALE TO MEDIUM-SCALE INDUSTRIAL MANUFACTURING	MEDIUM-SCALE TO SMALL-SCALE INDUSTRIAL MANUFACTURING
RECOMMENDED USE	INDUSTRIAL PRODUCTION	INDUSTRIAL PRODUCTION	INDUSTRIAL/REMODELER	REMODELER
MATERIALS	Ideal for chipboard, MDF, HDF and laminates. Nonprotruding center-point and spurs make this tool perfect for low-thickness panels.	Ideal for chipboard, MDF, HDF and laminates.	Excellent for both hard and soft wood. Great for chipboard, MDF, HDF and laminates.	Excellent for both hard and soft wood. Good for chipboard, MDF, and laminates.
SHARPENING & MAINTENANCE	Flat edges with reinforced spurs allow perfect finishing and prolonged drilling. 	Specially designed reinforced spurs allow for impeccable finishing during operations involving high-speed cutting feed. 	Specially designed reinforced spurs allow for impeccable finishing during operations involving high-speed cutting feed. 	Standard design with negatively ground spurs providing good quality finishing without chipping. 
CARBIDE	INDUSTRIAL CHROMIUM MICROGRAIN CARBIDE The premium quality carbide produces clean bores with no rough edges and maintains a balanced center point. In addition to its safety features, Chromium Micrograin Carbide guarantees exceptional resistance to fatigue and abrasion and allows for an infinite number of resharpenings.	INDUSTRIAL CHROMIUM MICROGRAIN CARBIDE The special chromium enhanced carbide produces clean bores with no rough edges and maintains a balanced center point. In addition to its safety features, Chromium Micrograin Carbide guarantees exceptional resistance to fatigue and abrasion and allows for an infinite number of resharpenings.	INDUSTRIAL SINTERHIP HI-DENSITY CARBIDE The unique tip is made of high quality carbide enhanced via Sinterhip (hot isostatic pressing). This process guarantees long lasting performance and exceptionally clean bores.	INDUSTRIAL GRADE CARBIDE Fine and medium grain carbide grade guarantee reliable prolonged use.
COATING	SOLID TUNGSTEN CARBIDE	SOLID TUNGSTEN CARBIDE	C.M.T'S P.T.F.E COATING provides a non-stick surface preventing resin, glue or sludge residue accumulation on the bit body. Baked at 420°, this unique industrial material is specifically designed to fit woodworking tool requirements.	C.M.T'S P.T.F.E COATING provides a non-stick surface preventing resin, glue or sludge residue accumulation on the bit body. Baked at 420°, this unique industrial material is specifically designed to fit woodworking tool requirements.
PRICE RANGE	HIGH	HIGH	MEDIUM/HIGH	MEDIUM

## Solid Carbide Dowel Drills

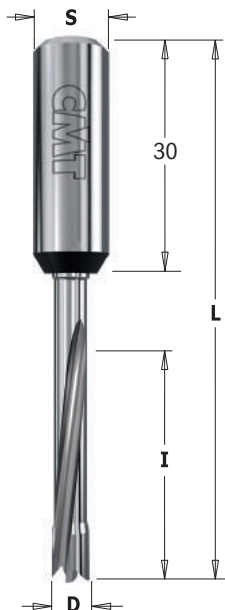

311.71/72



D mm	I mm	L mm	S mm	Box	ORDER NO. Right-hand rotation	ORDER NO. Left-hand rotation
5	30	70	10x30	50	311.050.71	311.050.72
8	30	70	10x30	50	311.080.71	311.080.72

**TECHNICAL DETAILS:**

- Premium quality super strength steel for improved resistance and durability
- Premium quality HWM spiral portion
- 2 cutting edges [Z2] + 2 curved ground spurs [V2]
- 2 spiral flutes
- Parallel shank with driving flat and adjustable screw length
- Recommended feed speed 1÷ 4m/minute -RPM 6000

**APPLICATION:**

ideal for use with chipboard, MDF, HDF and laminates. Best for boring holes in low thickness panels - no center-point or spurs. For use with chucks and boring Adapters on boring machines

Spare parts



Optional

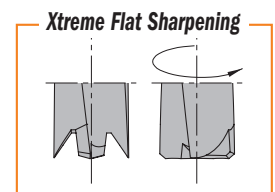
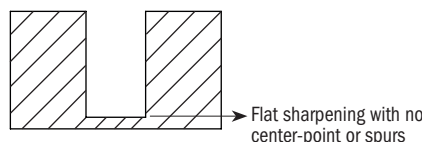

**CMT's new high quality dowel drills guarantee excellent performance and extra-long life!**

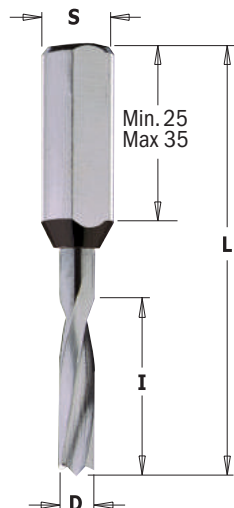

## 310.21/22 XTREME



D mm	I mm	L mm	S mm		ORDER NO. Right-hand rotation	ORDER NO. Left-hand rotation
1,3	5	57,5	10x30	50	<b>310.013.20*</b>	
2	12	57,5	10x27	50	<b>310.020.21</b>	<b>310.020.22</b>
3	9	57,5	10x35	50	<b>310.530.21</b>	<b>310.530.22</b>
3	18	57,5	10x25	50	<b>310.030.21</b>	<b>310.030.22</b>
4	20	57,5	10x25	50	<b>310.040.21</b>	<b>310.040.22</b>
5	22	57,5	10x27	50	<b>310.050.21</b>	<b>310.050.22</b>
6	22	57,5	10x27	50	<b>310.060.21</b>	<b>310.060.22</b>
6,35 (1/4")	22	57,5	10x27	50	<b>310.064.21</b>	<b>310.064.22</b>
8	22	57,5	10x25	50	<b>310.080.21</b>	<b>310.080.22</b>
10	22	57,5	10x25	50	<b>310.100.21</b>	<b>310.100.22</b>

\* Boring bit for panel preboring.  
Suitable for both right-hand and left-hand rotation.

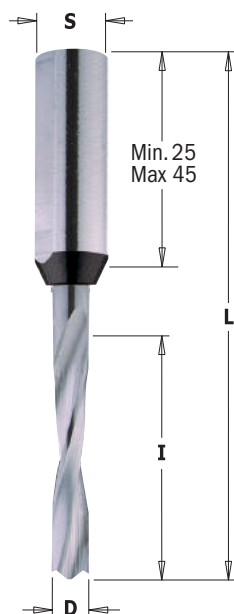
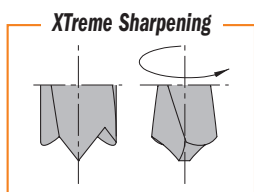
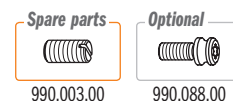

## 311.21/22 XTREME



D mm	I mm	L mm	S mm		ORDER NO. Right-hand rotation	ORDER NO. Left-hand rotation
1,3	5	70	10x45	50	<b>311.013.20*</b>	
2	12	70	10x40	50	<b>311.020.21</b>	<b>311.020.22</b>
3	18	70	10x40	50	<b>311.030.21</b>	<b>311.030.22</b>
3,5	18	70	10x40	50	<b>311.035.21</b>	<b>311.035.22</b>
4	27	70	10x28	50	<b>311.040.21</b>	<b>311.040.22</b>
5	30	70	10x28	50	<b>311.050.21</b>	<b>311.050.22</b>
6	30	70	10x27	50	<b>311.060.21</b>	<b>311.060.22</b>
6,35 (1/4")	30	70	10x30	50	<b>311.064.21</b>	<b>311.064.22</b>
8	35	70	10x25	50	<b>311.080.21</b>	<b>311.080.22</b>
10	35	70	10x25	50	<b>311.100.21</b>	<b>311.100.22</b>

\* Boring bit for panel preboring.  
Suitable for both right-hand and left-hand rotation.

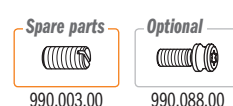

### TECHNICAL DETAILS:

- Premium quality super-strength steel.
- HWM spiral portion with centre point.
- 2 cutting edges [Z2].
- 2 spiral flutes.
- 2 curved, negatively ground spurs [V2].
- Parallel shank with driving flat and adjustable screw length.

### APPLICATION:

used on boring machines separately or with chucks for drilling blind holes in solid wood, wood composites, plastic and laminated materials.

**Perfect for all materials and long-lasting performance!**

## Grinding Wheels for XTreme Sharpening



### 01.02

D mm	DESCRIPTION	DIMENSION mm	B mm	PACK QTY.	ORDER NO.
Ø3 a 7	Grinding wheel for reshaping	Ø125x5,5	Ø20	1	<b>01.02.0316</b>
Ø8 a 10	Grinding wheel for reshaping	Ø125x7	Ø20	1	<b>01.02.0317</b>

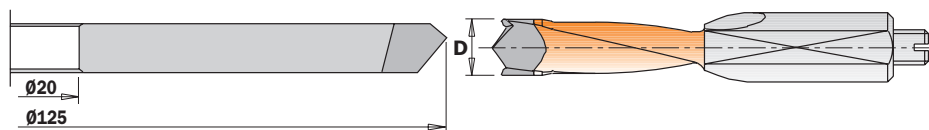

# Solid Carbide Dowel Drills for Through Holes

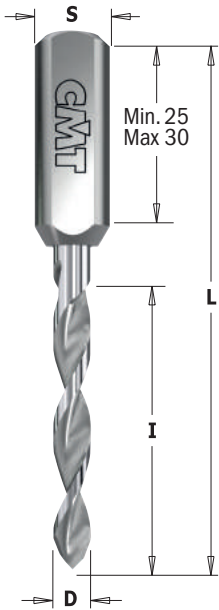

## 314.21/22 XTREME



D mm	I mm	L mm	S mm		ORDER NO. Right-hand rotation	ORDER NO. Left-hand rotation
3	27	70	10x30	50	<b>314.030.21</b>	<b>314.030.22</b>
4	35	70	10x26	50	<b>314.040.21</b>	<b>314.040.22</b>
5	35	70	10x26	50	<b>314.050.21</b>	<b>314.050.22</b>
6	35	70	10x26	50	<b>314.060.21</b>	<b>314.060.22</b>
8	35	70	10x26	50	<b>314.080.21</b>	<b>314.080.22</b>
10	35	70	10x27	50	<b>314.100.21</b>	<b>314.100.22</b>

For panels with maximum 20-30mm in thickness

**TECHNICAL DETAILS:**

- Premium quality super-strength steel.
- HWM spiral portion with centre point.
- 2 precision ground cutting edges [Z2].
- Double angle.
- 2 spiral flutes.
- Parallel shank with driving flat and adjustable screw length.



**APPLICATION:**

used on boring machines and dowel drilling devices.  
Use for drilling through holes in solid wood, wood composites, plastic and laminated materials.

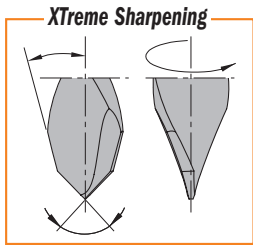

# Solid Carbide Dowel Drills

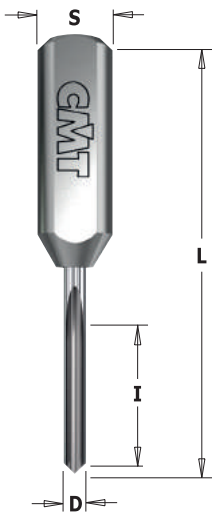

## 382 XTREME



D mm	I mm	L mm	S mm		ORDER NO. Right-hand & Left-hand rotation
2	12	57,5	10x30	50	<b>382.2057</b>
2	12	70	10x42,5	50	<b>382.2070</b>
2,5	16	57,5	10x24	50	<b>382.2557</b>
2,5	16	70	10x35	50	<b>382.2570</b>
3	15	57,5	10x26	50	<b>382.3057</b>
3	25	70	10x26	50	<b>382.3070</b>
3,5	18	57,5	10x24	50	<b>382.3557</b>
3,5	18	70	10x36	50	<b>382.3570</b>
5	25	57,5	10x25	50	<b>382.5057</b>
5	35	70	10x25	50	<b>382.5070</b>

**TECHNICAL DETAILS:**

- Premium quality HWM.
- Cutting head with precision balanced centre point.
- 1 cutting edge [Z1].
- Parallel shank with driving flat and length adjusting screw.

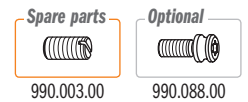

**APPLICATION:**

for drilling blind holes on solid wood, wood composites, plastic and laminated materials. For use on machining centres, point to point machines, CNC routers and hand-held routers equipped with chucks or Adapters.

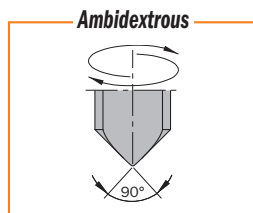

**SECURITY TIPS:**

These boring bits require more power compared to tradition dowel drills.  
The number of boring bits to be used in a single drilling unit depends on the machine power.



## Dowel Drills

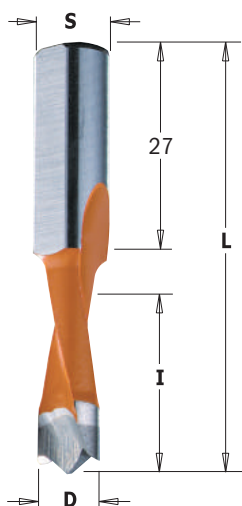

### 310.41/42 XTREME



D mm	I mm	L mm	S mm		ORDER NO. Right-hand rotation	ORDER NO. Left-hand rotation
5	27	57,5	10x27	50	<b>310.050.41</b>	<b>310.050.42</b>
6	27	57,5	10x27	50	<b>310.060.41</b>	<b>310.060.42</b>
7	27	57,5	10x27	50	<b>310.070.41</b>	<b>310.070.42</b>
8	27	57,5	10x27	50	<b>310.080.41</b>	<b>310.080.42</b>
9	27	57,5	10x27	50	<b>310.090.41</b>	<b>310.090.42</b>
10	27	57,5	10x27	50	<b>310.100.41</b>	<b>310.100.42</b>

**TECHNICAL DETAILS:**

- Premium quality super-strength steel.
- Spiral portion coated with orange or black P.T.F.E.
- Extra-fine micrograin carbide spiral portion with centre point.
- 2 cutting edges [Z2].
- 2 spiral flutes.
- 2 curved, negatively ground spurs [V2].
- Parallel shank with driving flat and adjustable screw length.

**Spare parts**



**Optional**



**Xtreme Sharpening**

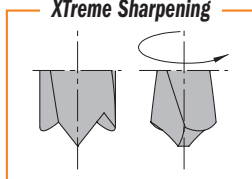

**APPLICATION:**

used on boring machines separately or with chucks for drilling blind holes in solid wood, wood composites, plastic and laminated materials.

## Dowel Drills

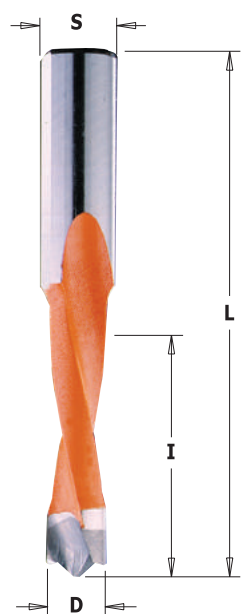

### 311.41/42 XTREME



D mm	I mm	L mm	S mm		ORDER NO. Right-hand rotation	ORDER NO. Left-hand rotation
5	35	70	10x30	50	<b>311.050.41</b>	<b>311.050.42</b>
6	35	70	10x30	50	<b>311.060.41</b>	<b>311.060.42</b>
7	35	70	10x30	50	<b>311.070.41</b>	<b>311.070.42</b>
8	35	70	10x30	50	<b>311.080.41</b>	<b>311.080.42</b>
<b>new</b> 8	45	70	10x19	50	<b>311.580.41*</b>	<b>311.580.42*</b>
9	35	70	10x30	50	<b>311.090.41</b>	<b>311.090.42</b>
10	35	70	10x30	50	<b>311.100.41</b>	<b>311.100.42</b>

**TECHNICAL DETAILS:**

- Premium quality super-strength steel.
- Spiral portion coated with orange or black P.T.F.E.
- Extra-fine micrograin carbide spiral portion with centre point.
- 2 cutting edges [Z2].
- 2 spiral flutes.
- 2 curved, negatively ground spurs [V2].
- Parallel shank with driving flat and adjustable screw length.

**Spare parts**



**Optional**



**Xtreme Sharpening**

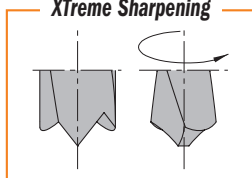

**APPLICATION:**

used on boring machines separately or with chucks for drilling blind holes in solid wood, wood composites, plastic and laminated materials.

\* Drill bits designed to fit Häfele one-piece Ixconnect SC 8/60 spreading connector.

### Perfect for all materials and long-lasting performance!

CMT announces the new series of solid carbide boring bits, now available from their extensive industrial line. These bits are entirely made of premium quality super micrograin carbide from Ceratizit in Luxemburg.

The entire series offers several design features:

- the unique tip has curved, negatively ground spurs to produce exceptionally clear bores with no rough edges. Centre point balanced;
- the cylindrical head is bigger than traditional tips and is extremely resistant to prolonged use.

It lasts longer between sharpenings;

- the plunge edge runs all the way to the centre of the bit to reduce drilling resistance and increase production speed;
- the solid carbide construction guarantees an almost infinite number of resharpenings, and since it is a solid unit of carbide, it offers extra safety features;
- ideal for hardwood and difficult composites such as particle boards, MDF and veneered wood.
- excellent performance on high-speed boring units and CNC routers.

## Dowel Drills for Through Holes

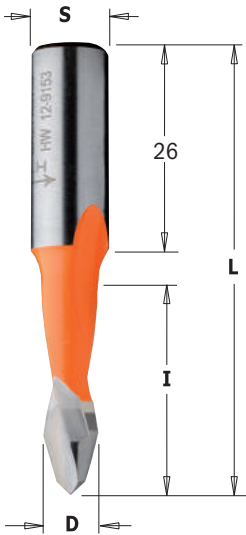

### 313.41/42 XTREME



D mm	I mm	L mm	S mm		ORDER NO. Right-hand rotation	ORDER NO. Left-hand rotation
5	27	57,5	10x26	50	<b>313.050.41</b>	<b>313.050.42</b>
8	27	57,5	10x26	50	<b>313.080.41</b>	<b>313.080.42</b>

For panels with maximum 20mm in thickness



**TECHNICAL DETAILS:**

- Super-strength steel.
- Spiral portion coated with orange or black P.T.F.E.
- Extra-fine micrograin carbide spiral portion with centre point.
- HW head with precision balanced centre point.
- 2 precision ground cutting edges [Z2].
- Double angle.
- 2 spiral flutes.
- Parallel shank with driving flat and length adjusting screw.

**APPLICATION:**

used on boring machines and dowel drilling devices. Use for drilling through holes in solid wood, wood composites, plastic and laminated materials.

**Xtreme Sharpening**

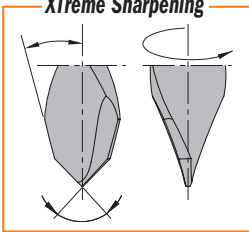

## Dowel Drills for Through Holes

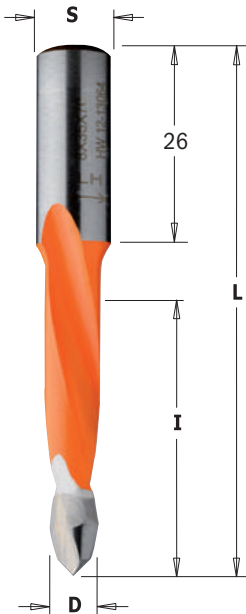

### 314.41/42 XTREME



D mm	I mm	L mm	S mm		ORDER NO. Right-hand rotation	ORDER NO. Left-hand rotation
5	35	70	10x26	50	<b>314.050.41</b>	<b>314.050.42</b>
6	35	70	10x26	50	<b>314.060.41</b>	<b>314.060.42</b>
7	35	70	10x26	50	<b>314.070.41</b>	<b>314.070.42</b>
8	35	70	10x26	50	<b>314.080.41</b>	<b>314.080.42</b>
10	35	70	10x26	50	<b>314.100.41</b>	<b>314.100.42</b>

For panels with maximum 30mm in thickness

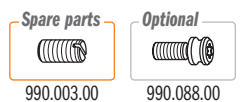

**TECHNICAL DETAILS:**

- Super-strength steel.
- Spiral portion coated with orange or black P.T.F.E.
- Extra-fine micrograin carbide spiral portion with centre point.
- HW head with precision balanced centre point.
- 2 precision ground cutting edges [Z2].
- Double angle.
- 2 spiral flutes.
- Parallel shank with driving flat and length adjusting screw.

**APPLICATION:**

used on boring machines and dowel drilling devices. Use for drilling through holes in solid wood, wood composites, plastic and laminated materials.

### Perfect for all materials and long-lasting performance!

CMT announces the new series of solid carbide boring bits, now available from their extensive industrial line. These bits are entirely made of premium quality super micrograin carbide from Ceratizit in Luxemburg.

The entire series offers several design features:

- the unique tip has curved, negatively ground spurs to produce exceptionally clear bores with no rough edges. Centre point balanced;
- the cylindrical head is bigger than traditional tips and is extremely resistant to prolonged use.

It lasts longer between sharpenings;

- the plunge edge runs all the way to the centre of the bit to reduce drilling resistance and increase production speed;
- the solid carbide construction guarantees an almost infinite number of resharpenings, and since it is a solid unit of carbide, it offers extra safety features;
- ideal for hardwood and difficult composites such as particle boards, MDF and veneered wood.
- excellent performance on high-speed boring units and CNC routers.

## Adapters for Twist Drills

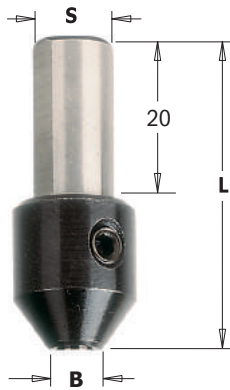

### 364

B mm	L mm	S mm			ORDER NO.
2	38	10x20		10	<b>364.020.00</b>
2,5	38	10x20		10	<b>364.025.00</b>
3	38	10x20		10	<b>364.030.00</b>
3,2	38	10x20		10	<b>364.032.00</b>
3,5	38	10x20		10	<b>364.035.00</b>
4	38	10x20		10	<b>364.040.00</b>
4,5	38	10x20		10	<b>364.045.00</b>
5	38	10x20		10	<b>364.050.00</b>

For use with the following items: 363 HWM

**TECHNICAL DETAILS:**

- Super-strength steel.
- Quick and secure assembly on twist drills.
- Precision relief.
- Parallel shank with driving flat.

**APPLICATION:**

for use with twist drills with common shank and bushing diameter. Used on boring machines equipped with Adapter chucks.

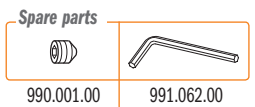

## Bushings for Twist Drills



### 365

B mm	L mm	S mm			ORDER NO.
2	23	10		50	<b>365.020.00</b>
2,5	23	10		50	<b>365.025.00</b>
3	23	10		50	<b>365.030.00</b>
3,2	23	10		50	<b>365.032.00</b>
3,5	23	10		50	<b>365.035.00</b>
4	23	10		50	<b>365.040.00</b>
4,5	23	10		50	<b>365.045.00</b>
5	23	10		50	<b>365.050.00</b>
6	23	10		50	<b>365.060.00</b>

For use with the following items: 363 HWM

**TECHNICAL DETAILS:**

- Super-strength steel.
- Shank with driving flat.
- Axial cuttings for cylindrical drill clamps.

**APPLICATION:**

used with spiral boring bits with shank diameters equal to the bushing diameter. Used on boring machines equipped with Adapters.

### Assembly Illustration

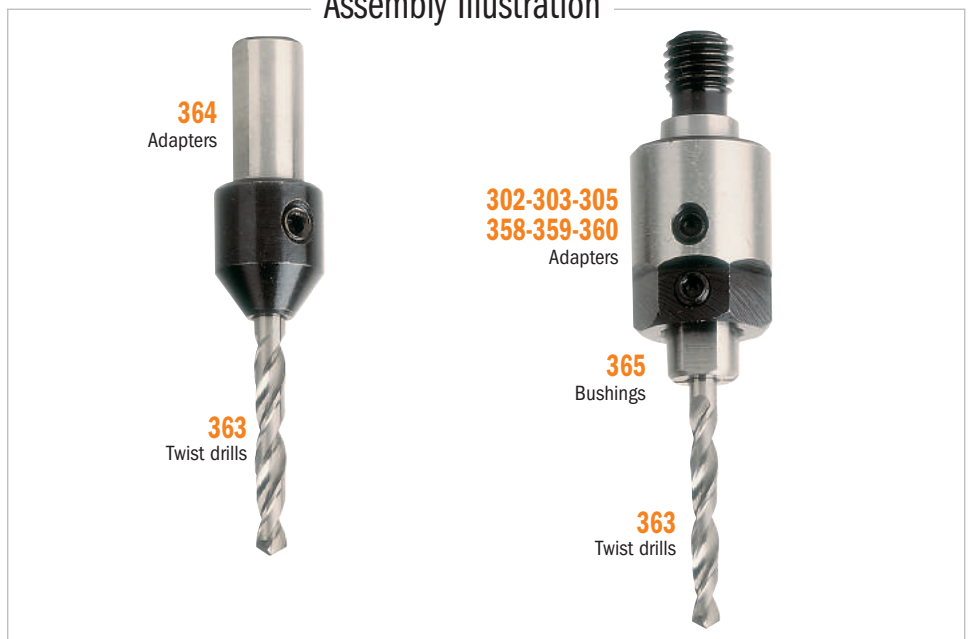

## Solid Carbide Twist Drills "V" Point Sharpening

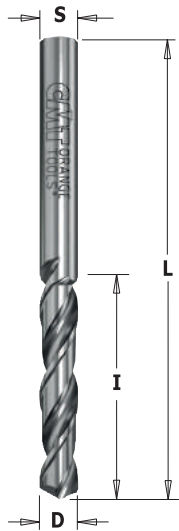

**363**

HWM LONG LIFE Z2 RH LH

S=D mm	I mm	L mm		ORDER NO. Right-hand rotation	ORDER NO. Left-hand rotation
2	25	50	50	<b>363.020.11</b>	<b>363.020.12</b>
2,5	27	55	50	<b>363.025.11</b>	<b>363.025.12</b>
3	27	55	50	<b>363.030.11</b>	<b>363.030.12</b>
3,2	27	55	50	<b>363.032.11</b>	<b>363.032.12</b>
3,5	27	55	50	<b>363.035.11</b>	<b>363.035.12</b>
4	27	55	50	<b>363.040.11</b>	<b>363.040.12</b>
4,5	28	60	50	<b>363.045.11</b>	<b>363.045.12</b>
5	28	60	50	<b>363.050.11</b>	<b>363.050.12</b>

For use with the following items: 364-365

**TECHNICAL DETAILS:**

- Premium quality HWM.
- 2 precision ground cutting edges [Z2].
- 2 spiral flutes.
- Common shank and drilling diameter (S=D).

**APPLICATION:**

used in Adapter bushings.

## Solid Carbide Twist Drills "V" Point 60° Sharpening

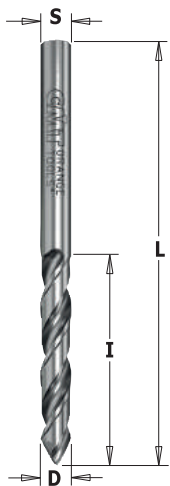

**363**

HWM LONG LIFE Z2 RH LH

S=D mm	I mm	L mm		ORDER NO. Right-hand rotation	ORDER NO. Left-hand rotation
2,5	27	55	50	<b>363.025.41</b>	<b>363.025.42</b>
3	27	55	50	<b>363.030.41</b>	<b>363.030.42</b>
3,5	27	55	50	<b>363.035.41</b>	<b>363.035.42</b>
4	27	55	50	<b>363.040.41</b>	<b>363.040.42</b>

For use with the following items: 364-365

**TECHNICAL DETAILS:**

- Premium quality HWM.
- 2 precision ground cutting edges [Z2].
- 2 spiral flutes.
- Common shank and drilling diameter (S=D).

**APPLICATION:**

used in Adapter bushings.

## Solid Carbide Twist Drills Negatively Ground Spurs Sharpening

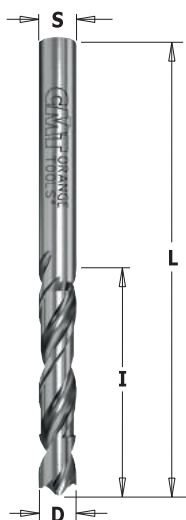

**363**

HWM LONG LIFE Z2 RH LH

S=D mm	I mm	L mm		ORDER NO. Right-hand rotation	ORDER NO. Left-hand rotation
2,5	27	55	50	<b>363.025.21</b>	<b>363.025.22</b>
3	27	55	50	<b>363.030.21</b>	<b>363.030.22</b>
4	27	55	50	<b>363.040.21</b>	<b>363.040.22</b>
5	28	60	50	<b>363.050.21</b>	<b>363.050.22</b>

For use with the following items: 364-365

**TECHNICAL DETAILS:**

- Premium quality HWM.
- 2 precision ground cutting edges [Z2].
- 2 spiral flutes.
- Common shank and drilling diameter (S=D).

**APPLICATION:**

used in Adapter bushings.



## 2 Flute Dowel Drills

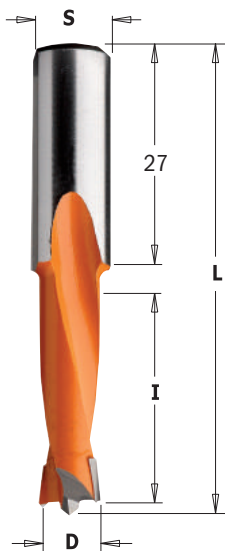

**Negatively Ground Spurs**

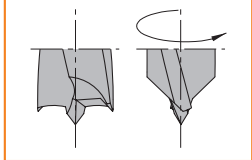

### 310



D mm	I mm	L mm	S mm		ORDER NO. Right-hand rotation	ORDER NO. Left-hand rotation
4	27	57,5	10x27	50	<b>310.040.11</b>	<b>310.040.12</b>
4,5	27	57,5	10x27	50	<b>310.045.11</b>	<b>310.045.12</b>
4,76	27	57,5	10x27	50	<b>310.047.11</b>	<b>310.047.12</b>
5	27	57,5	10x27	50	<b>310.050.11</b>	<b>310.050.12</b>
5,1	27	57,5	10x27	50	<b>310.051.11</b>	<b>310.051.12</b>
5,2	27	57,5	10x27	50	<b>310.052.11</b>	<b>310.052.12</b>
5,55	27	57,5	10x27	50	<b>310.055.11</b>	<b>310.055.12</b>
6	27	57,5	10x27	50	<b>310.060.11</b>	<b>310.060.12</b>
6,35	27	57,5	10x27	50	<b>310.064.11</b>	<b>310.064.12</b>
6,5	27	57,5	10x27	50	<b>310.065.11</b>	<b>310.065.12</b>
7	27	57,5	10x27	50	<b>310.070.11</b>	<b>310.070.12</b>
8	27	57,5	10x27	50	<b>310.080.11</b>	<b>310.080.12</b>
8,2	27	57,5	10x27	50	<b>310.082.11</b>	<b>310.082.12</b>
9	27	57,5	10x27	50	<b>310.090.11</b>	<b>310.090.12</b>
9,52	27	57,5	10x27	50	<b>310.095.11</b>	<b>310.095.12</b>
10	27	57,5	10x27	50	<b>310.100.11</b>	<b>310.100.12</b>
11	27	57,5	10x27	10	<b>310.110.11</b>	<b>310.110.12</b>
12	27	57,5	10x27	10	<b>310.120.11</b>	<b>310.120.12</b>
12,7	27	57,5	10x27	10	<b>310.127.11</b>	<b>310.127.12</b>
13	27	57,5	10x27	10	<b>310.130.11</b>	<b>310.130.12</b>
14	27	57,5	10x27	10	<b>310.140.11</b>	<b>310.140.12</b>
15	27	57,5	10x27	10	<b>310.150.11</b>	<b>310.150.12</b>
16	27	57,5	10x27	10	<b>310.160.11</b>	<b>310.160.12</b>

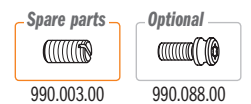

## 2 Flute Dowel Drills

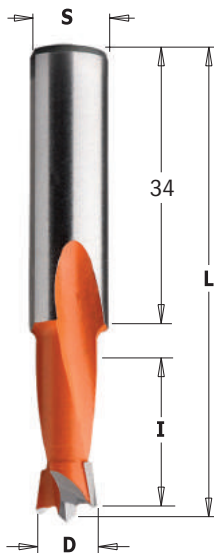

**Negatively Ground Spurs**

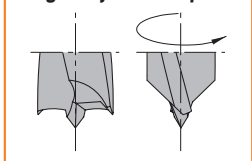

### 361



D mm	I mm	L mm	S mm		ORDER NO. Right-hand rotation	ORDER NO. Left-hand rotation
5	18	57,5	10x34	50	<b>361.050.11</b>	<b>361.050.12</b>
6	18	57,5	10x34	50	<b>361.060.11</b>	<b>361.060.12</b>
7	18	57,5	10x34	50	<b>361.070.11</b>	<b>361.070.12</b>
8	18	57,5	10x34	50	<b>361.080.11</b>	<b>361.080.12</b>
10	18	57,5	10x34	50	<b>361.100.11</b>	<b>361.100.12</b>

**TECHNICAL DETAILS:**

- Super-strength steel.
- Spiral portion coated with orange or black P.T.F.E.
- HW head with precision balanced centre point.
- 2 HW precision ground cutting edges [Z2].
- 2 negatively ground spurs [V2]
- 2 spiral flutes.
- Parallel shank with driving flat and length adjusting screw.

**APPLICATION:**

used on boring machines equipped with Adapters or chucks.  
Used to drill blind holes in solid wood, wood composites, plastic and laminated materials.

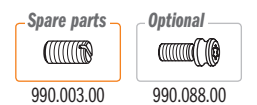

## 2 Flute Dowel Drills

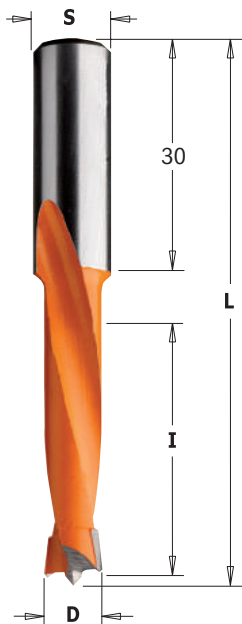

Negatively Ground Spurs

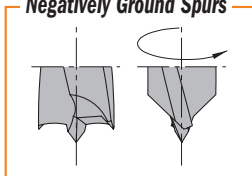

### 311



D mm	I mm	L mm	S mm		ORDER NO. Right-hand rotation	ORDER NO. Left-hand rotation
4	35	70	10x30	50	311.040.11	311.040.12
4,5	35	70	10x30	50	311.045.11	311.045.12
4,76	35	70	10x30	50	311.047.11	311.047.12
5	35	70	10x30	50	311.050.11	311.050.12
5,1	35	70	10x30	50	311.051.11	311.051.12
5,2	35	70	10x30	50	311.052.11	311.052.12
5,55	35	70	10x30	50	311.055.11	311.055.12
6	35	70	10x30	50	311.060.11	311.060.12
6,35	35	70	10x30	50	311.064.11	311.064.12
6,5	35	70	10x30	50	311.065.11	311.065.12
7	35	70	10x30	50	311.070.11	311.070.12
8	35	70	10x30	50	311.080.11	311.080.12
8,2	35	70	10x30	50	311.082.11	311.082.12
9	35	70	10x30	50	311.090.11	311.090.12
9,52	35	70	10x30	50	311.095.11	311.095.12
10	35	70	10x30	50	311.100.11	311.100.12
11	35	70	10x30	10	311.110.11	311.110.12
11,1	35	70	10x30	10	311.111.11	311.111.12
12	35	70	10x30	10	311.120.11	311.120.12
12,7	35	70	10x30	10	311.127.11	311.127.12
13	35	70	10x30	10	311.130.11	311.130.12
14	35	70	10x30	10	311.140.11	311.140.12
15	35	70	10x30	10	311.150.11	311.150.12
16	35	70	10x30	10	311.160.11	311.160.12

Spare parts



Optional



## 2 Flute Dowel Drills

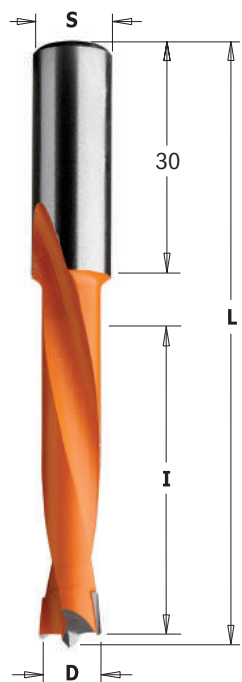

Negatively Ground Spurs

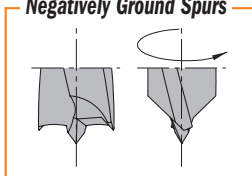

### 362



D mm	I mm	L mm	S mm		ORDER NO. Right-hand rotation	ORDER NO. Left-hand rotation
5	44	77	10x30	50	362.050.11	362.050.12
6	44	77	10x30	50	362.060.11	362.060.12
7	44	77	10x30	50	362.070.11	362.070.12
8	44	77	10x30	50	362.080.11	362.080.12
10	44	77	10x30	50	362.100.11	362.100.12
12	44	77	10x30	10	362.120.11	362.120.12

**TECHNICAL DETAILS:**

- Super-strength steel.
- Spiral portion coated with orange or black P.T.F.E.
- HW head with precision balanced centre point.
- 2 HW precision ground cutting edges [Z2].
- 2 negatively ground spurs [V2].
- 2 spiral flutes.
- Parallel shank with driving flat and length adjusting screw.

Spare parts



Optional



**APPLICATION:**

used on boring machines equipped with Adapters or chucks.  
Used to drill blind holes in solid wood, wood composites, plastic and laminated materials.

## 4 Flute Dowel Drills

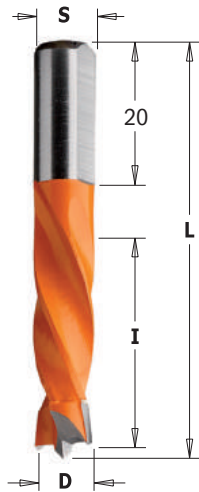

### 306



D mm	I mm	L mm	S mm		ORDER NO. Right-hand rotation	ORDER NO. Left-hand rotation
• 3	18	55,5	8x20	50	<b>306.030.21</b>	
5	30	55,5	8x20	50	<b>306.050.11</b>	<b>306.050.12</b>
5,55	30	55,5	8x20	50	<b>306.055.11</b>	<b>306.055.12</b>
6	30	55,5	8x20	50	<b>306.060.11</b>	<b>306.060.12</b>
6,35	30	55,5	8x20	50	<b>306.064.11</b>	<b>306.064.12</b>
7	30	55,5	8x20	50	<b>306.070.11</b>	<b>306.070.12</b>
8	30	55,5	8x20	50	<b>306.080.11</b>	<b>306.080.12</b>
9	30	55,5	8x20	50	<b>306.090.11</b>	<b>306.090.12</b>
10	30	55,5	8x20	50	<b>306.100.11</b>	<b>306.100.12</b>
12	30	55,5	8x20	50	<b>306.120.11</b>	<b>306.120.12</b>

• HWM

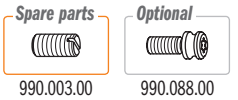

#### Negatively Ground Spurs

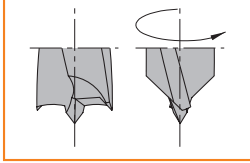

## 4 Flute Dowel Drills

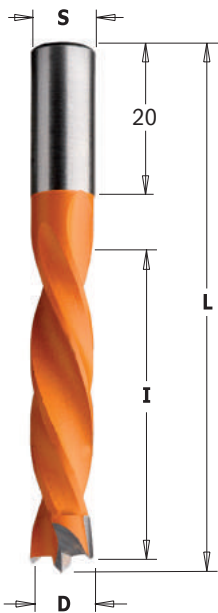

### 307



D mm	I mm	L mm	S mm		ORDER NO. Right-hand rotation	ORDER NO. Left-hand rotation
5	40	67	8x20	50	<b>307.050.11</b>	<b>307.050.12</b>
5,55	40	67	8x20	50	<b>307.055.11</b>	<b>307.055.12</b>
6	40	67	8x20	50	<b>307.060.11</b>	<b>307.060.12</b>
6,35	40	67	8x20	50	<b>307.064.11</b>	<b>307.064.12</b>
7	40	67	8x20	50	<b>307.070.11</b>	<b>307.070.12</b>
8	40	67	8x20	50	<b>307.080.11</b>	<b>307.080.12</b>
9	40	67	8x20	50	<b>307.090.11</b>	<b>307.090.12</b>
9,52	40	67	8x20	50	<b>307.095.11</b>	<b>307.095.12</b>
10	40	67	8x20	50	<b>307.100.11</b>	<b>307.100.12</b>
12	40	67	8x20	10	<b>307.120.11</b>	<b>307.120.12</b>

#### TECHNICAL DETAILS:

- Super-strength steel.
- Cutter portion coated with black or orange P.T.F.E.
- HW head with precision balanced centre point.
- 2 HW precision ground cutting edges [Z2].
- Negatively ground spurs [V2].
- 4 spiral flutes.
- Parallel shank with driving flat and length adjusting screw.

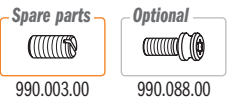

#### Negatively Ground Spurs

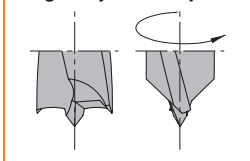

#### APPLICATION:

used on boring machines equipped with Adapters or chucks.  
Used to drill blind holes in solid wood, wood composites, plastic and laminated materials.

## 4 Flute Dowel Drills

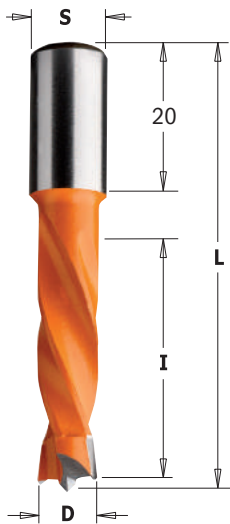

Negatively Ground Spurs

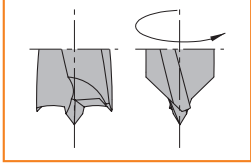

### 308



D mm	I mm	L mm	S mm		ORDER NO. Right-hand rotation	ORDER NO. Left-hand rotation
4	26	57,5	10x20	50	308.040.11	308.040.12
5	30	57,5	10x20	50	308.050.11	308.050.12
6	30	57,5	10x20	50	308.060.11	308.060.12
6,35	30	57,5	10x20	50	308.064.11	308.064.12
7	30	57,5	10x20	50	308.070.11	308.070.12
8	30	57,5	10x20	50	308.080.11	308.080.12
9	30	57,5	10x20	50	308.090.11	308.090.12
9,52	30	57,5	10x20	50	308.095.11	308.095.12
10	30	57,5	10x20	50	308.100.11	308.100.12
11	30	57,5	10x20	10	308.110.11	308.110.12
12	30	57,5	10x20	10	308.120.11	308.120.12
12,7	30	57,5	10x20	10	308.127.11	308.127.12
13	30	57,5	10x20	10	308.130.11	308.130.12
14	30	57,5	10x20	10	308.140.11	308.140.12
15	30	57,5	10x20	10	308.150.11	308.150.12
16	30	57,5	10x20	10	308.160.11	308.160.12



## 4 Flute Dowel Drills

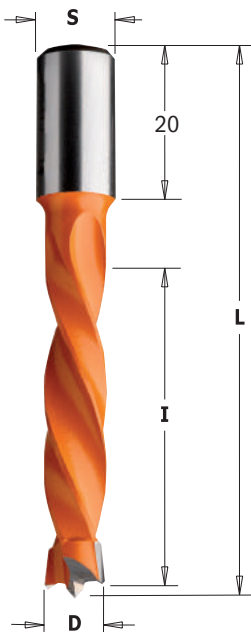

Negatively Ground Spurs

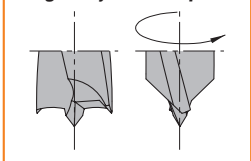

### 309



D mm	I mm	L mm	S mm		ORDER NO. Right-hand rotation	ORDER NO. Left-hand rotation
4	43	70	10x20	50	309.040.11	309.040.12
5	43	70	10x20	50	309.050.11	309.050.12
6	43	70	10x20	50	309.060.11	309.060.12
6,35	43	70	10x20	50	309.064.11	309.064.12
7	43	70	10x20	50	309.070.11	309.070.12
7,5	43	70	10x20	50	309.075.11	309.075.12
8	43	70	10x20	50	309.080.11	309.080.12
9	43	70	10x20	50	309.090.11	309.090.12
9,52	43	70	10x20	50	309.095.11	309.095.12
10	43	70	10x20	50	309.100.11	309.100.12
11	43	70	10x20	10	309.110.11	309.110.12
12	43	70	10x20	10	309.120.11	309.120.12
12,7	43	70	10x20	10	309.127.11	309.127.12
13	43	70	10x20	10	309.130.11	309.130.12
14	43	70	10x20	10	309.140.11	309.140.12
15	43	70	10x20	10	309.150.11	309.150.12
16	43	70	10x20	10	309.160.11	309.160.12



**TECHNICAL DETAILS:**

- Super-strength steel.
- Cutter portion coated with black or orange P.T.F.E.
- HW head with precision balanced centre point.
- 2 HW precision ground cutting edges [Z2].
- Negatively ground spurs [V2].
- 4 spiral flutes.
- Parallel shank with driving flat and length adjusting screw.

**APPLICATION:**

used on boring machines equipped with Adapters or chucks.  
Used to drill blind holes in solid wood, wood composites, plastic and laminated materials.



## 4 Flute Dowel Drills

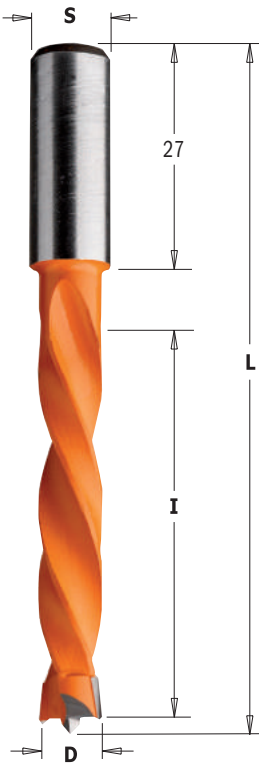

### 373



D mm	I mm	L mm	S mm		ORDER NO. Right-hand rotation	ORDER NO. Left-hand rotation
5	50	85	10x27	50	<b>373.050.11</b>	<b>373.050.12</b>
6	50	85	10x27	50	<b>373.060.11</b>	<b>373.060.12</b>
7	50	85	10x27	50	<b>373.070.11</b>	<b>373.070.12</b>
8	50	85	10x27	50	<b>373.080.11</b>	<b>373.080.12</b>
10	50	85	10x27	50	<b>373.100.11</b>	<b>373.100.12</b>
12	50	85	10x27	10	<b>373.120.11</b>	<b>373.120.12</b>

**TECHNICAL DETAILS:**

- Super-strength steel.
- Cutter portion coated with black or orange P.T.F.E.
- HW head with precision balanced centre point.
- 2 HW precision ground cutting edges [Z2].
- Negatively ground spurs [V2].
- 4 spiral flutes.
- Parallel shank with driving flat and length adjusting screw.

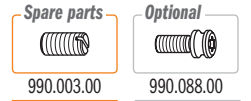

**APPLICATION:**

used on boring machines equipped with adapters or chucks.  
Used to drill blind holes in solid wood, wood composites, plastic and laminated materials.

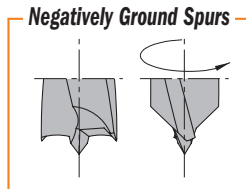

## 4 Flute Dowel Drills

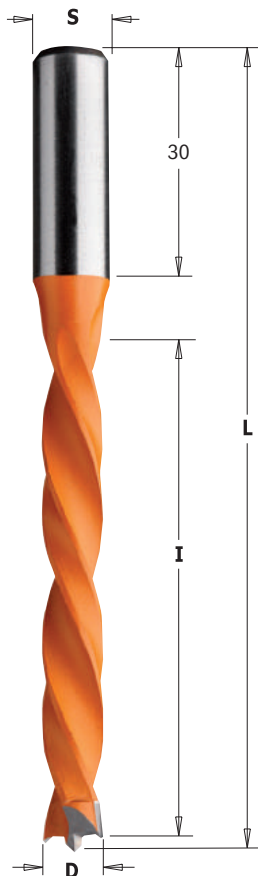

### 372



D mm	I mm	L mm	S mm		ORDER NO. Right-hand rotation	ORDER NO. Left-hand rotation
5	65	105	10x30	10	<b>372.050.11</b>	<b>372.050.12</b>
6	65	105	10x30	10	<b>372.060.11</b>	<b>372.060.12</b>
7	65	105	10x30	10	<b>372.070.11</b>	<b>372.070.12</b>
8	65	105	10x30	10	<b>372.080.11</b>	<b>372.080.12</b>
10	65	105	10x30	10	<b>372.100.11</b>	<b>372.100.12</b>
12	65	105	10x30	10	<b>372.120.11</b>	<b>372.120.12</b>

**TECHNICAL DETAILS:**

- Super-strength steel.
- Cutter portion coated with black or orange P.T.F.E.
- HW head with precision balanced centre point.
- 2 HW precision ground cutting edges [Z2].
- Negatively ground spurs [V2].
- 4 spiral flutes.
- Parallel shank with driving flat and length adjusting screw.

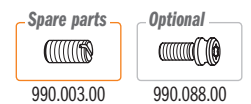

**APPLICATION:**

used on boring machines equipped with adapters or chucks.  
Used to drill blind holes in solid wood, wood composites, plastic and laminated materials.

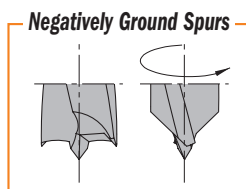

## Dowel Drills with Countersink

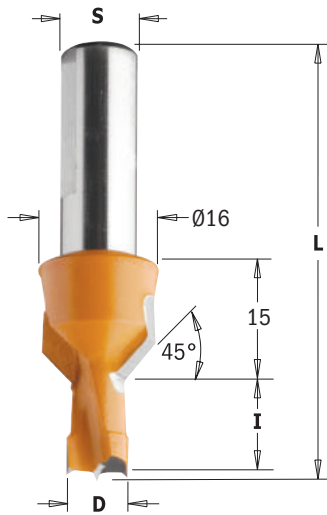

**Negatively Ground Spurs**

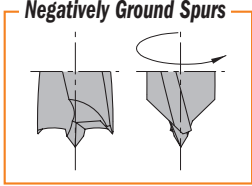

### 376-377



D mm	I mm	L mm	S mm		ORDER NO. Right-hand rotation	ORDER NO. Left-hand rotation
8	12	57,5	10	10	<b>376.080.11</b>	<b>376.080.12</b>
8	13	57,5	10	10	<b>376.083.11</b>	<b>376.083.12</b>
8	15	57,5	10	10	<b>376.081.11</b>	<b>376.081.12</b>
8	20	57,5	10	10	<b>376.082.11</b>	<b>376.082.12</b>
10	12	57,5	10	10	<b>376.100.11</b>	<b>376.100.12</b>
10	13	57,5	10	10	<b>376.103.11</b>	<b>376.103.12</b>
10	15	57,5	10	10	<b>376.101.11</b>	<b>376.101.12</b>
10	20	57,5	10	10	<b>376.102.11</b>	<b>376.102.12</b>
8	12	70	10	10	<b>377.080.11</b>	<b>377.080.12</b>
8	13	70	10	10	<b>377.083.11</b>	<b>377.083.12</b>
8	15	70	10	10	<b>377.081.11</b>	<b>377.081.12</b>
8	20	70	10	10	<b>377.082.11</b>	<b>377.082.12</b>
10	12	70	10	10	<b>377.100.11</b>	<b>377.100.12</b>
10	13	70	10	10	<b>377.103.11</b>	<b>377.103.12</b>
10	15	70	10	10	<b>377.101.11</b>	<b>377.101.12</b>
10	20	70	10	10	<b>377.102.11</b>	<b>377.102.12</b>

**TECHNICAL DETAILS:**

- Super-strength steel.
- Spiral portion coated with orange or black P.T.F.E.
- HW head with precision balanced centre point.
- 2 precision ground cutting edges [Z2].
- 2 ground spurs [V2].
- 2 spiral flutes.
- Parallel shank with driving flat and length adjusting screw.

**Spare parts**



990.003.00

**Optional**



990.088.00

**APPLICATION:**

used for drilling and countersinking in solid wood, wood composites, plastic and laminated materials. Suitable for high performance speed on boring machines equipped with adapters or chucks.

## Dowel Drills for Through Holes with Countersink

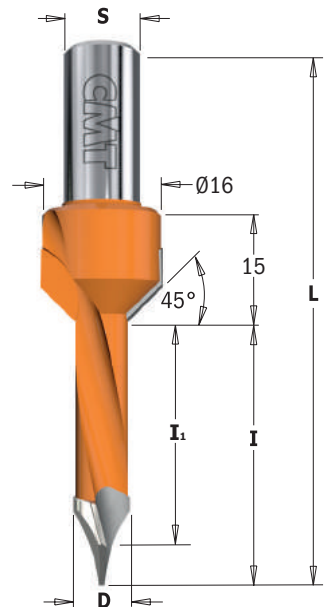

**60° Through Holes**

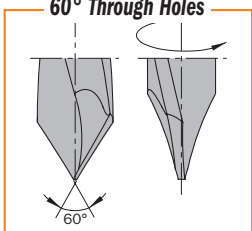

### 378



D mm	I mm	I <sub>1</sub> mm	L mm	S mm		ORDER NO. Right-hand rotation	ORDER NO. Left-hand rotation
5	35	31	70	10	10	<b>378.052.11</b>	<b>378.052.12</b>
7	35	29,5	70	10	10	<b>378.072.11</b>	<b>378.072.12</b>
8	35	29	70	10	10	<b>378.082.11</b>	<b>378.082.12</b>
10	35	26,5	70	10	10	<b>378.102.11</b>	<b>378.102.12</b>

**TECHNICAL DETAILS:**

- Super-strength steel.
- Spiral portion coated with orange or black P.T.F.E.
- HW head with precision balanced centre point.
- 2 precision ground cutting edges [Z2].
- 2 ground spurs [V2].
- 2 spiral flutes.
- Parallel shank with driving flat and length adjusting screw.

**Spare parts**



990.003.00

**Optional**



990.088.00

**APPLICATION:**

used for drilling and countersinking in solid wood, wood composites, plastic and laminated materials. Suitable for high performance speed on boring machines equipped with adapters or chucks.

## 2 Flute Dowel Drills for Through Holes

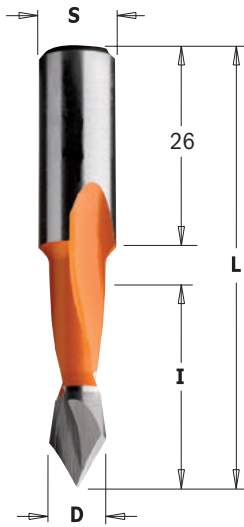

60° Through Holes

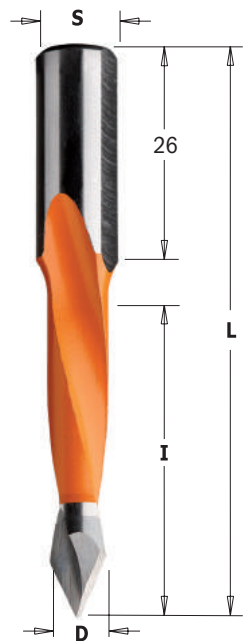
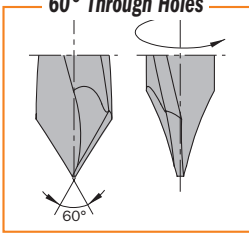

60° Through Holes

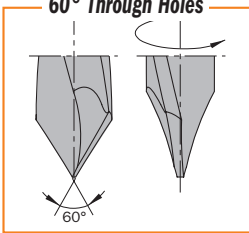

### 313



D mm	I mm	L mm	S mm		ORDER NO. Right-hand rotation	ORDER NO. Left-hand rotation
5	27	57,5	10x26	50	<b>313.050.11</b>	<b>313.050.12</b>
6	27	57,5	10x26	50	<b>313.060.11</b>	<b>313.060.12</b>
8	27	57,5	10x26	50	<b>313.080.11</b>	<b>313.080.12</b>
10	27	57,5	10x26	50	<b>313.100.11</b>	<b>313.100.12</b>

For panels with maximum 20mm in thickness.

**TECHNICAL DETAILS:**

- Super-strength steel.
- Spiral portion coated with orange or black P.T.F.E.
- HW head with precision balanced centre point.
- 2 precision ground cutting edges [Z2].
- 2 spiral flutes.
- Parallel shank with driving flat and length adjusting screw.

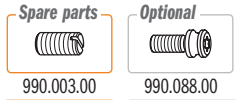

**APPLICATION:**

used on boring machines and dowel drilling devices.  
Use for drilling through holes in solid wood, wood composites, plastic and laminated materials.

### 314



D mm	I mm	L mm	S mm		ORDER NO. Right-hand rotation	ORDER NO. Left-hand rotation
4	30	70	10x26	50	<b>314.040.11</b>	<b>314.040.12</b>
4,76	35	70	10x26	50	<b>314.047.11</b>	<b>314.047.12</b>
5	35	70	10x26	50	<b>314.050.11</b>	<b>314.050.12</b>
5,55	35	70	10x26	50	<b>314.055.11</b>	<b>314.055.12</b>
6	35	70	10x26	50	<b>314.060.11</b>	<b>314.060.12</b>
6,35	35	70	10x26	50	<b>314.064.11</b>	<b>314.064.12</b>
7	35	70	10x26	50	<b>314.070.11</b>	<b>314.070.12</b>
8	35	70	10x26	50	<b>314.080.11</b>	<b>314.080.12</b>
9	35	70	10x26	50	<b>314.090.11</b>	<b>314.090.12</b>
9,52	35	70	10x26	50	<b>314.095.11</b>	<b>314.095.12</b>
10	35	70	10x26	50	<b>314.100.11</b>	<b>314.100.12</b>
12	35	70	10x26	10	<b>314.120.11</b>	<b>314.120.12</b>
12,7	35	70	10x26	10	<b>314.127.11</b>	<b>314.127.12</b>

For panels with maximum 25-30mm in thickness.

### 366

D mm	I mm	L mm	S mm		ORDER NO. Right-hand rotation	ORDER NO. Left-hand rotation
5	44	77	10x26	50	<b>366.050.11</b>	<b>366.050.12</b>
6	44	77	10x26	50	<b>366.060.11</b>	<b>366.060.12</b>
8	44	77	10x26	50	<b>366.080.11</b>	<b>366.080.12</b>
10	44	77	10x26	50	<b>366.100.11</b>	<b>366.100.12</b>
12	44	77	10x26	10	<b>366.120.11</b>	<b>366.120.12</b>

For panels with maximum 30-40mm in thickness.

**TECHNICAL DETAILS:**

- Super-strength steel.
- Spiral portion coated with orange or black P.T.F.E.
- HW head with precision balanced centre point.
- 2 precision ground cutting edges [Z2].
- 2 spiral flutes.
- Parallel shank with driving flat and length adjusting screw.

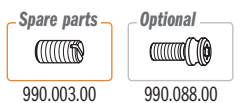

**APPLICATION:**

used on boring machines and dowel drilling devices.  
Use for drilling through holes in solid wood, wood composites, plastic and laminated materials.

## 4 Flute Dowel Drills for Through Holes

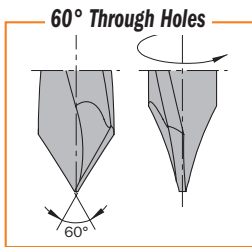
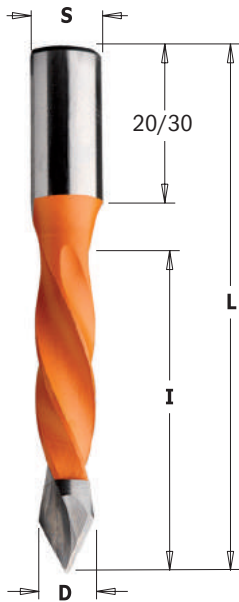

### 374 For panels with maximum 20-25mm in thickness.



D mm	I mm	L mm	S mm		ORDER NO. Right-hand rotation	ORDER NO. Left-hand rotation
5	30	57,5	10x20	50	<b>374.050.11</b>	<b>374.050.12</b>
8	30	57,5	10x20	50	<b>374.080.11</b>	<b>374.080.12</b>

### 375 For panels with maximum 30-35mm in thickness.

D mm	I mm	L mm	S mm		ORDER NO. Right-hand rotation	ORDER NO. Left-hand rotation
4	40	70	10x20	50	<b>375.040.11</b>	<b>375.040.12</b>
5	40	70	10x20	50	<b>375.050.11</b>	<b>375.050.12</b>
6	40	70	10x20	50	<b>375.060.11</b>	<b>375.060.12</b>
7	40	70	10x20	50	<b>375.070.11</b>	<b>375.070.12</b>
8	40	70	10x20	50	<b>375.080.11</b>	<b>375.080.12</b>
9	40	70	10x20	50	<b>375.090.11</b>	<b>375.090.12</b>
10	40	70	10x20	50	<b>375.100.11</b>	<b>375.100.12</b>

### 381 For panels with maximum 60-65mm in thickness.

D mm	I mm	L mm	S mm		ORDER NO. Right-hand rotation	ORDER NO. Left-hand rotation
5	70	115	10x30	10	<b>381.050.11</b>	<b>381.050.12</b>
6	70	115	10x30	10	<b>381.060.11</b>	<b>381.060.12</b>
8	70	115	10x30	10	<b>381.080.11</b>	<b>381.080.12</b>
10	70	115	10x30	10	<b>381.100.11</b>	<b>381.100.12</b>

**TECHNICAL DETAILS:**

- Super-strength steel
- Spiral portion coated with orange or black P.T.F.E.
- HW head with precision balanced centre point
- 2 precision ground cutting edges [Z2] - 4 spiral flutes
- Parallel shank with driving flat and length adjusting screw.

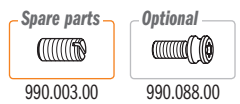

**APPLICATION:**

used on boring machines and dowel drilling devices.  
Use for drilling through holes in solid wood, wood composites, plastic and laminated materials.

## 2 Flute Dowel Drills for Through Holes

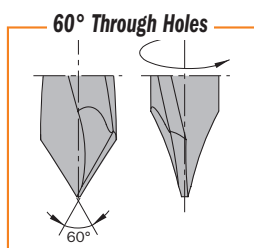
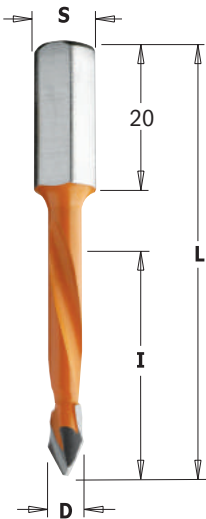

### 367



D mm	I mm	L mm	S mm		ORDER NO. Right-hand rotation	ORDER NO. Left-hand rotation
5	30	56	8x20	50	<b>367.050.11</b>	<b>367.050.12</b>
8	30	56	8x20	50	<b>367.080.11</b>	<b>367.080.12</b>

For panels with maximum 20-25mm in thickness.

### 368

D mm	I mm	L mm	S mm		ORDER NO. Right-hand rotation	ORDER NO. Left-hand rotation
5	43	70	8x20	50	<b>368.050.11</b>	<b>368.050.12</b>
6	43	70	8x20	50	<b>368.060.11</b>	<b>368.060.12</b>
7	43	70	8x20	50	<b>368.070.11</b>	<b>368.070.12</b>
8	43	70	8x20	50	<b>368.080.11</b>	<b>368.080.12</b>

For panels with maximum 35-40mm in thickness

**TECHNICAL DETAILS:**

- Super-strength steel
- Spiral portion coated with orange or black P.T.F.E.
- HW head with precision balanced centre point
- 2 precision ground cutting edges [Z2]
- 2 spiral flutes
- Parallel shank with driving flat and length adjusting screw.

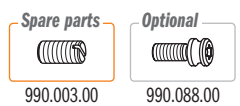

**APPLICATION:**

used on boring machines and dowel drilling devices.  
Use for drilling through holes in solid wood, wood composites, plastic and laminated materials.



## Countersinks for 2 Flutes Dowel Drills

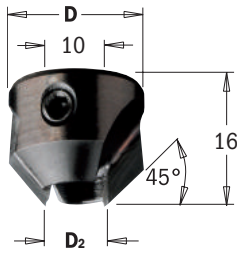

### 315



D <sub>2</sub> mm	D mm		ORDER NO. Right-hand rotation	ORDER NO. Left-hand rotation
5 ~ 10	20	10	<b>315.200.11</b>	<b>315.200.12</b>
11 ~ 12	22	10	<b>315.220.11</b>	<b>315.220.12</b>



**TECHNICAL DETAILS:**

- Super-strength steel.
- 2 precision ground carbide tipped cutting edges [Z2].
- Direct clamp on the shank of the drills.

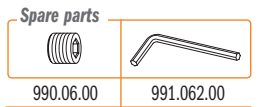

**APPLICATION:**

used for chamfering and drilling in solid wood, wood composites, plastic and laminated materials.

## Countersinks for 4 Flutes Dowel Drills

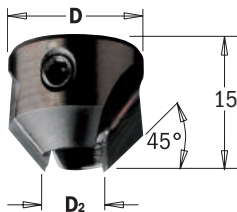

### 316



D <sub>2</sub> mm	D mm		ORDER NO. Right-hand rotation	ORDER NO. Left-hand rotation
4	16	10	<b>316.040.11</b>	<b>316.040.12</b>
5	16	10	<b>316.050.11</b>	<b>316.050.12</b>
6	16	10	<b>316.060.11</b>	<b>316.060.12</b>
7	16	10	<b>316.070.11</b>	<b>316.070.12</b>
8	18	10	<b>316.080.11</b>	<b>316.080.12</b>
9	18	10	<b>316.090.11</b>	<b>316.090.12</b>
10	20	10	<b>316.100.11</b>	<b>316.100.12</b>
12	20	10	<b>316.120.11</b>	<b>316.120.12</b>



**TECHNICAL DETAILS:**

- Super-strength steel.
- 2 HW precision ground cutting edges [Z2].

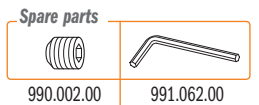

**APPLICATION:**

used for drilling and chamfering in solid wood, wood composites, plastic and laminated materials.

## 3-Flute Solid Carbide Countersink 90°

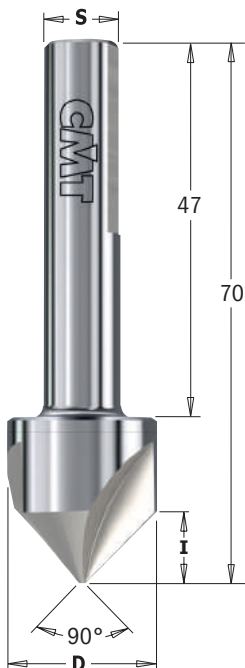

### 521



D mm	I mm	L mm	S mm		ORDER NO. Right-hand rotation
19,5	9	70	10x47	10	<b>521.002.21</b>

**TECHNICAL DETAILS:**

- Super strength steel.
- 3 HWM precision ground cutting edges [Z3].

**APPLICATION:**

used for chamfering and drilling in solid wood, wood composites, plastic and laminated materials. To use on boring machines and CNC.

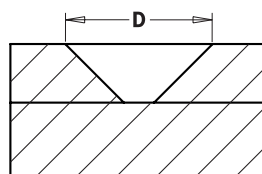

LINE	XTREME DIAMOND	XTREME FLAT	INDUSTRIAL with chipbreaker	INDUSTRIAL
PERFORMANCE	SUPERIOR ★★★★★	SUPERIOR ★★★★★	EXCELLENT ★★★	VERY GOOD ★★★
BIT				
DESCRIPTION	Designed for heavy duty drilling in Large-Scale Industrial Manufacturing ensuring high impact resistance, greater durability and good chip evacuation thanks to the chipbreaker.	Designed for heavy duty drilling in Large-Scale Industrial Manufacturing ensuring high impact resistance and greater durability.	Designed for medium-duty to light-duty drilling in medium-scale to small-scale industrial manufacturing ensuring good chip evacuation thanks to the chipbreaker.	Designed for medium-duty to light-duty drilling in medium-scale to small-scale industrial manufacturing ensuring rigorous impact resistance and good durability.
USER	LARGE-SCALE INDUSTRIAL MANUFACTURING	LARGE-SCALE INDUSTRIAL MANUFACTURING	LARGE-SCALE TO MEDIUM-SCALE INDUSTRIAL MANUFACTURING	LARGE-SCALE TO MEDIUM-SCALE INDUSTRIAL MANUFACTURING
RECOMMENDED USE	INDUSTRIAL PRODUCTION	INDUSTRIAL PRODUCTION	INDUSTRIAL/REMODELER	INDUSTRIAL/REMODELER
MATERIALS	Ideal for chipboard, MDF, HDF, laminates and abrasive panels where long lifetime is required.	Ideal for chipboard, MDF, HDF and laminates. Non-protruding center-point and spurs make this tool perfect for low-thickness panels.	Excellent for solid wood. Good for chipboard, MDF, HDF and laminates.	Excellent for solid wood. Good for chipboard, MDF, HDF and laminates.
SHARPENING & MAINTENANCE	NEGATIVELY GROUND SPURS: standard design with HW head with precision balanced centre point, 2 HW precision ground cutting edges with chipbreaker and 2 negatively ground spurs.	XTREME FLAT SHARPENING: flat edges with reinforced spurs allow perfect finishing and prolonged drilling at high-speed cutting feed.	NEGATIVELY GROUND SPURS: standard design with HW head with precision balanced centre point, 2 HW precision ground cutting edges with chipbreaker and 2 negatively ground spurs.	NEGATIVELY GROUND SPURS: standard design with HW head with precision balanced centre point, 2 HW precision ground cutting edges and 2 negatively ground spurs.
DIAMOND / CARBIDE	The special polycrystalline diamond formula increases tool life up to 20 times longer than HW hinge bits. Good number of resharpenings guaranteed. The best quality/price ratio	INDUSTRIAL CHROMIUM MICROGRAIN CARBIDE The special chromium enhanced carbide produces clean bores with no rough edges even in the corners. In addition Chromium Micrograin Carbide guarantees exceptional resistance to fatigue and abrasion for longer lifetime.	INDUSTRIAL GRADE CARBIDE Fine and medium grain carbide grade guarantee reliable prolonged use.	INDUSTRIAL GRADE CARBIDE Fine and medium grain carbide grade guarantee reliable prolonged use.
COATING	High-quality nickel-plated with anti-friction and anti-corrosion properties.	C.M.T.'s P.T.F.E coating provides a non-stick surface preventing resin, glue or sludge residue accumulation on the bit body. Baked at 420°, this unique industrial material is specifically designed to fit woodworking tool requirements.	C.M.T.'s P.T.F.E coating provides a non-stick surface preventing resin, glue or sludge residue accumulation on the bit body. Baked at 420°, this unique industrial material is specifically designed to fit woodworking tool requirements.	C.M.T.'s P.T.F.E coating provides a non-stick surface preventing resin, glue or sludge residue accumulation on the bit body. Baked at 420°, this unique industrial material is specifically designed to fit woodworking tool requirements.
PRICE RANGE	HIGH	MEDIUM/HIGH	MEDIUM	MEDIUM

## DP Hinge Boring Bits with Chipbreaker

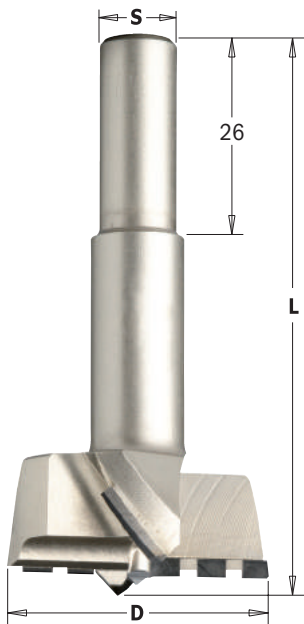

### 317-369

DP
LONG LIFE
Z2R
V2
RH
LH
20X LONGER LIFE THAN CARBIDE

D mm	L mm	S mm		ORDER NO. Right-hand rotation	ORDER NO. Left-hand rotation
15*	57,5	10x26	10	<b>317.150.61</b>	<b>317.150.62</b>
35	57,5	10x26	10	<b>317.350.61</b>	<b>317.350.62</b>
15*	70	10x26	10	<b>369.150.61</b>	<b>369.150.62</b>
35	70	10x26	10	<b>369.350.61</b>	<b>369.350.62</b>

\*without chipbreaker

#### TECHNICAL DETAILS:

- Super-strength steel.
- DP head with precision balanced centre point.
- 2 DP precision ground cutting edges with chipbreaker [Z2R].
- 2 DP negatively ground spurs [V2].
- Parallel shank with driving flat and length adjusting screw.

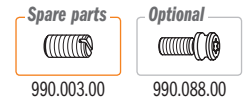

#### APPLICATION:

**ideal for hinges.** Use on boring machines equipped with adapters or chucks. Use for drilling accurate and clean-cut blind holes in wood composites, plastic and laminated materials. Boring performance 20 times longer than HW materials.

**REMARK:** special dimensions available on request.

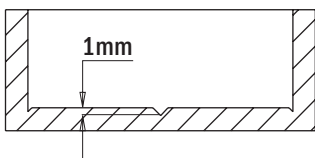

New construction with 1mm centre point

# Hinge Boring Bits

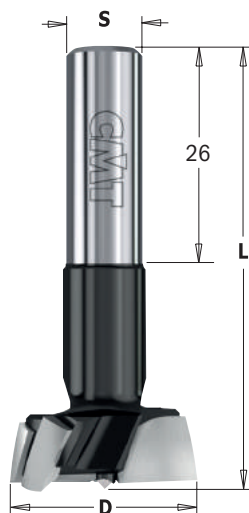

**Xtreme Sharpening Curved Spurs**



**New construction with 0,8mm centre point**

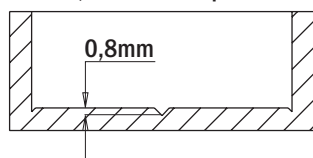

## 317 XTREME



D mm	L mm	S mm		ORDER NO. Right-hand rotation	ORDER NO. Left-hand rotation
15	57,5	10x26	10	<b>317.150.41</b>	<b>317.150.42</b>
18	57,5	10x26	10	<b>317.180.41</b>	<b>317.180.42</b>
20	57,5	10x26	10	<b>317.200.41</b>	<b>317.200.42</b>
25	57,5	10x26	10	<b>317.250.41</b>	<b>317.250.42</b>
26	57,5	10x26	10	<b>317.260.41</b>	<b>317.260.42</b>
35*	57,5	10x26	10	<b>317.350.41</b>	<b>317.350.42</b>

## 369 XTREME



D mm	L mm	S mm		ORDER NO. Right-hand rotation	ORDER NO. Left-hand rotation
15	70	10x26	10	<b>369.150.41</b>	<b>369.150.42</b>
18	70	10x26	10	<b>369.180.41</b>	<b>369.180.42</b>
20	70	10x26	10	<b>369.200.41</b>	<b>369.200.42</b>
25	70	10x26	10	<b>369.250.41</b>	<b>369.250.42</b>
26	70	10x26	10	<b>369.260.41</b>	<b>369.260.42</b>
35*	70	10x26	10	<b>369.350.41</b>	<b>369.350.42</b>

\*with chipbreaker

**TECHNICAL DETAILS:**

- Super-strength steel.
- Cutter portion coated with orange or black P.T.F.E.
- HW head with precision balanced centre point.
- 2 HW precision ground cutting edges [Z2].
- 2 negatively ground spurs [V2].
- Parallel shank with driving flat and length adjusting screw.

Spare parts



990.003.00

Optional



990.088.00

**APPLICATION:**

**ideal for hinges.** Use on boring machines equipped with adapters or chucks. Use for drilling accurate and clean-cut blind holes in solid wood, wood composites, plastic and laminated materials.

# Hinge Boring Bits with Chipbreaker

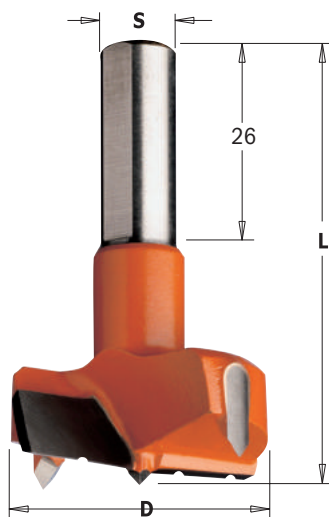

**New construction with 1mm centre point**

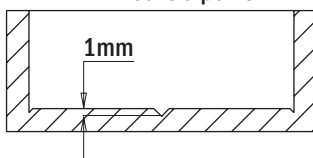

## 317C - 369C



D mm	L mm	S mm		ORDER NO. Right-hand rotation	ORDER NO. Left-hand rotation
35	57,5	10x26	10	<b>317.350.11C</b>	<b>317.350.12C</b>
40	57,5	10x26	10	<b>317.400.11C</b>	<b>317.400.12C</b>
45	57,5	10x26	10	<b>317.450.11C</b>	<b>317.450.12C</b>
35	70	10x26	10	<b>369.350.11C</b>	<b>369.350.12C</b>
40	70	10x26	10	<b>369.400.11C</b>	<b>369.400.12C</b>
45	70	10x26	10	<b>369.450.11C</b>	<b>369.450.12C</b>

**TECHNICAL DETAILS:**

- Super-strength steel.
- Cutter portion coated with orange or black P.T.F.E.
- HW head with precision balanced centre point.
- 2 HW precision ground cutting edges with chipbreaker [Z2R].
- 2 negatively ground spurs [V2].
- Parallel shank with driving flat and length adjusting screw.

Spare parts



990.003.00

Optional



990.088.00

**APPLICATION:**

**ideal for hinges.** Used on boring machines equipped with adapters or chucks. For drilling accurate and clean-cut blind holes in solid wood.

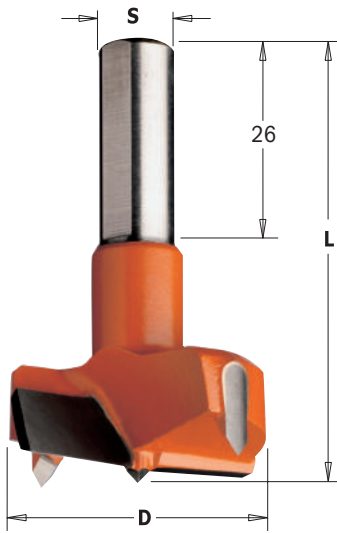

New construction with  
1mm centre point

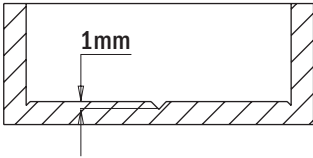

## 317



D mm	L mm	S mm		ORDER NO. Right-hand rotation	ORDER NO. Left-hand rotation
14	57,5	10x26	10	317.140.11	317.140.12
15	57,5	10x26	10	317.150.11	317.150.12
16	57,5	10x26	10	317.160.11	317.160.12
17	57,5	10x26	10	317.170.11	317.170.12
18	57,5	10x26	10	317.180.11	317.180.12
19	57,5	10x26	10	317.190.11	317.190.12
20	57,5	10x26	10	317.200.11	317.200.12
22	57,5	10x26	10	317.220.11	317.220.12
24	57,5	10x26	10	317.240.11	317.240.12
25	57,5	10x26	10	317.250.11	317.250.12
26	57,5	10x26	10	317.260.11	317.260.12
28	57,5	10x26	10	317.280.11	317.280.12
30	57,5	10x26	10	317.300.11	317.300.12
32	57,5	10x26	10	317.320.11	317.320.12
34	57,5	10x26	10	317.340.11	317.340.12
35	57,5	10x26	10	317.350.11	317.350.12
38	57,5	10x26	10	317.380.11	317.380.12
40	57,5	10x26	10	317.400.11	317.400.12
42	57,5	10x26	10	317.420.11	317.420.12
45	57,5	10x26	10	317.450.11	317.450.12
50	57,5	10x26	10	317.500.11	317.500.12
55	57,5	10x26	10	317.550.11	317.550.12
60	57,5	10x26	10	317.600.11	317.600.12

### TECHNICAL DETAILS:

- Super-strength steel.
- Cutter portion coated with orange or black P.T.F.E.
- HW head with precision balanced centre point.
- 2 HW precision ground cutting edges [Z2].
- 2 negatively ground spurs [V2].
- Parallel shank with driving flat and length adjusting screw.

### APPLICATION:

**ideal for hinges.** Use on boring machines equipped with adapters or chucks. Use for drilling accurate and clean-cut blind holes in solid wood, wood composites, plastic and laminated materials.

## 369



D mm	L mm	S mm		ORDER NO. Right-hand rotation	ORDER NO. Left-hand rotation
14	70	10x26	10	369.140.11	369.140.12
15	70	10x26	10	369.150.11	369.150.12
16	70	10x26	10	369.160.11	369.160.12
18	70	10x26	10	369.180.11	369.180.12
20	70	10x26	10	369.200.11	369.200.12
22	70	10x26	10	369.220.11	369.220.12
25	70	10x26	10	369.250.11	369.250.12
26	70	10x26	10	369.260.11	369.260.12
30	70	10x26	10	369.300.11	369.300.12
35	70	10x26	10	369.350.11	369.350.12
40	70	10x26	10	369.400.11	369.400.12
45	70	10x26	10	369.450.11	369.450.12
50	70	10x26	10	369.500.11	369.500.12
55	70	10x26	10	369.550.11	369.550.12
60	70	10x26	10	369.600.11	369.600.12

## 370



D mm	L mm	S mm		ORDER NO. Right-hand rotation	ORDER NO. Left-hand rotation
18	77	10x30	10	370.180.11	370.180.12
20	77	10x30	10	370.200.11	370.200.12
25	77	10x30	10	370.250.11	370.250.12
30	77	10x30	10	370.300.11	370.300.12
35	77	10x30	10	370.350.11	370.350.12

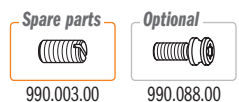



## Dowel Drills with Threaded Shank with Countersink

**HW Z2 V2 RH LH**

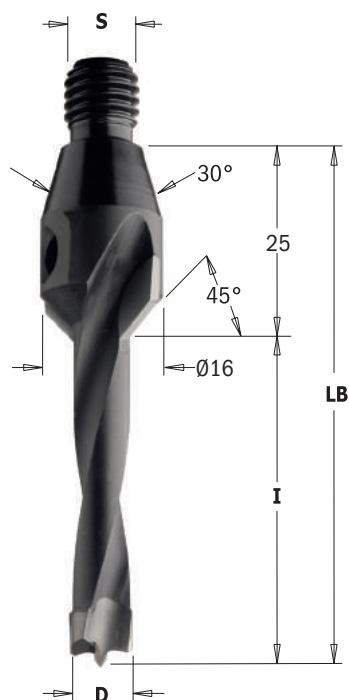

### 332-334-336-337

D mm	I mm	LB mm	S mm		ORDER NO. Right-hand rotation	ORDER NO. Left-hand rotation
5	20	45	M10/30°	10	<b>332.050.11</b>	<b>332.050.12</b>
6	20	45	M10/30°	10	<b>332.060.11</b>	<b>332.060.12</b>
8	20	45	M10/30°	10	<b>332.080.11</b>	<b>332.080.12</b>
10	20	45	M10/30°	10	<b>332.100.11</b>	<b>332.100.12</b>
12	20	45	M10/30°	10	<b>332.120.11</b>	<b>332.120.12</b>
5	30	55	M10/30°	10	<b>334.050.11</b>	<b>334.050.12</b>
6	30	55	M10/30°	10	<b>334.060.11</b>	<b>334.060.12</b>
8	30	55	M10/30°	10	<b>334.080.11</b>	<b>334.080.12</b>
10	30	55	M10/30°	10	<b>334.100.11</b>	<b>334.100.12</b>
12	30	55	M10/30°	10	<b>334.120.11</b>	<b>334.120.12</b>
5	40	65	M10/30°	10	<b>336.050.11</b>	<b>336.050.12</b>
6	40	65	M10/30°	10	<b>336.060.11</b>	<b>336.060.12</b>
8	40	65	M10/30°	10	<b>336.080.11</b>	<b>336.080.12</b>
10	40	65	M10/30°	10	<b>336.100.11</b>	<b>336.100.12</b>
12	40	65	M10/30°	10	<b>336.120.11</b>	<b>336.120.12</b>
5	50	75	M10/30°	10	<b>337.050.11</b>	<b>337.050.12</b>
6	50	75	M10/30°	10	<b>337.060.11</b>	<b>337.060.12</b>
8	50	75	M10/30°	10	<b>337.080.11</b>	<b>337.080.12</b>
10	50	75	M10/30°	10	<b>337.100.11</b>	<b>337.100.12</b>
12	50	75	M10/30°	10	<b>337.120.11</b>	<b>337.120.12</b>

**TECHNICAL DETAILS:**

- Super-strength steel.
- HW head with precision balanced centre point.
- 2 precision ground cutting edge [Z2].
- 2 ground spurts [V2].
- 2 spiral flutes.

**APPLICATION:**

used on boring machines equipped with chucks. Used to drill blind holes in solid wood, wood composites, plastic and laminated materials.

## Dowel Drills with Threaded Shank without Countersink



### 341-342-343

**HW Z2 V2 RH LH**

D mm	I mm	LB mm	S mm		ORDER NO. Right-hand rotation	ORDER NO. Left-hand rotation
5	30	55	M10/30°	10	<b>341.050.11</b>	<b>341.050.12</b>
6	30	55	M10/30°	10	<b>341.060.11</b>	<b>341.060.12</b>
8	30	55	M10/30°	10	<b>341.080.11</b>	<b>341.080.12</b>
10	30	55	M10/30°	10	<b>341.100.11</b>	<b>341.100.12</b>
12	30	55	M10/30°	10	<b>341.120.11</b>	<b>341.120.12</b>
5	40	65	M10/30°	10	<b>342.050.11</b>	<b>342.050.12</b>
6	40	65	M10/30°	10	<b>342.060.11</b>	<b>342.060.12</b>
8	40	65	M10/30°	10	<b>342.080.11</b>	<b>342.080.12</b>
10	40	65	M10/30°	10	<b>342.100.11</b>	<b>342.100.12</b>
12	40	65	M10/30°	10	<b>342.120.11</b>	<b>342.120.12</b>
5	50	75	M10/30°	10	<b>343.050.11</b>	<b>343.050.12</b>
6	50	75	M10/30°	10	<b>343.060.11</b>	<b>343.060.12</b>
8	50	75	M10/30°	10	<b>343.080.11</b>	<b>343.080.12</b>
10	50	75	M10/30°	10	<b>343.100.11</b>	<b>343.100.12</b>
12	50	75	M10/30°	20	<b>343.120.11</b>	<b>343.120.12</b>

**TECHNICAL DETAILS:**

- Super-strength steel.
- HW head with precision balanced centre point.
- 2 precision ground cutting edges [Z2].
- 2 ground spurts [V2].
- 4 spiral flutes.

**APPLICATION:**

used on boring machines equipped with chucks. Used to drill blind holes in solid wood, wood composites, plastic and laminated materials.

## Dowel Drills with Threaded Shank with Countersink

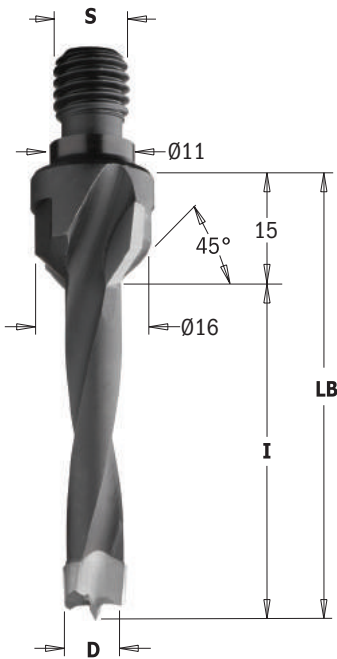

### 325-327-329-330



D mm	I mm	LB mm	S mm		ORDER NO. Right-hand rotation	ORDER NO. Left-hand rotation
5	20	35	M10/11x4	10	325.050.11	325.050.12
6	20	35	M10/11x4	10	325.060.11	325.060.12
8	20	35	M10/11x4	10	325.080.11	325.080.12
10	20	35	M10/11x4	10	325.100.11	325.100.12
12	20	35	M10/11x4	10	325.120.11	325.120.12
5	30	45	M10/11x4	10	327.050.11	327.050.12
6	30	45	M10/11x4	10	327.060.11	327.060.12
8	30	45	M10/11x4	10	327.080.11	327.080.12
10	30	45	M10/11x4	10	327.100.11	327.100.12
12	30	45	M10/11x4	10	327.120.11	327.120.12
5	40	55	M10/11x4	10	329.050.11	329.050.12
6	40	55	M10/11x4	10	329.060.11	329.060.12
8	40	55	M10/11x4	10	329.080.11	329.080.12
10	40	55	M10/11x4	10	329.100.11	329.100.12
12	40	55	M10/11x4	10	329.120.11	329.120.12
5	50	65	M10/11x4	10	330.050.11	330.050.12
6	50	65	M10/11x4	10	330.060.11	330.060.12
8	50	65	M10/11x4	10	330.080.11	330.080.12
10	50	65	M10/11x4	10	330.100.11	330.100.12
12	50	65	M10/11x4	10	330.120.11	330.120.12

**TECHNICAL DETAILS:**

- Super-strength steel.
- HW head with precision balanced centre point.
- 2 precision ground cutting edges [Z2].
- 2 spiral flutes.
- 2 ground spurs [V2].

**APPLICATION:**

used on boring machines equipped with chucks. Used to drill blind holes in solid wood, wood composites, plastic and laminated materials.

## Dowel Drills with Threaded Shank without Countersink



### 338-339-340



D mm	I mm	LB mm	S mm		ORDER NO. Right-hand rotation	ORDER NO. Left-hand rotation
5	30	45	M10/11x4	10	338.050.11	338.050.12
6	30	45	M10/11x4	10	338.060.11	338.060.12
8	30	45	M10/11x4	10	338.080.11	338.080.12
10	30	45	M10/11x4	10	338.100.11	338.100.12
12	30	45	M10/11x4	10	338.120.11	338.120.12
5	40	55	M10/11x4	10	339.050.11	339.050.12
6	40	55	M10/11x4	10	339.060.11	339.060.12
8	40	55	M10/11x4	10	339.080.11	339.080.12
10	40	55	M10/11x4	10	339.100.11	339.100.12
12	40	55	M10/11x4	10	339.120.11	339.120.12
5	50	65	M10/11x4	10	340.050.11	340.050.12
6	50	65	M10/11x4	10	340.060.11	340.060.12
8	50	65	M10/11x4	10	340.080.11	340.080.12
10	50	65	M10/11x4	10	340.100.11	340.100.12
12	50	65	M10/11x4	10	340.120.11	340.120.12

**TECHNICAL DETAILS:**

- Super-strength steel.
- HW head with precision balanced centre point.
- 2 precision ground cutting edges [Z2].
- 2 ground spurs [V2].
- 4 spiral flutes.

**APPLICATION:**

used on boring machines equipped with chucks. Used to drill blind holes in solid wood, wood composites, plastic and laminated materials.

## Dowel Drills with Threaded Shank



### 344

**HW Z2 V2 RH LH**

D mm	I mm	LB mm	S mm		ORDER NO. Right-hand rotation	ORDER NO. Left-hand rotation
5	43	63	M8	10	<b>344.050.11</b>	<b>344.050.12</b>
6	43	63	M8	10	<b>344.060.11</b>	<b>344.060.12</b>
8	43	63	M8	10	<b>344.080.11</b>	<b>344.080.12</b>
10	43	63	M8	10	<b>344.100.11</b>	<b>344.100.12</b>
12	43	63	M8	10	<b>344.120.11</b>	<b>344.120.12</b>

**FOR USE ON THE FOLLOWING MACHINES:**

Nottmeyer (older models)

### 346

**HW Z2 V2 RH LH**

D mm	I mm	LB mm	S mm		ORDER NO. Right-hand rotation	ORDER NO. Left-hand rotation
5	43	63	M10	10	<b>346.050.11</b>	<b>346.050.12</b>
6	43	63	M10	10	<b>346.060.11</b>	<b>346.060.12</b>
8	43	63	M10	10	<b>346.080.11</b>	<b>346.080.12</b>
10	43	63	M10	10	<b>346.100.11</b>	<b>346.100.12</b>
12	43	63	M10	10	<b>346.120.11</b>	<b>346.120.12</b>

**FOR USE ON THE FOLLOWING MACHINES:**

Ayen, Holzma, Knoevenagel, Mayer, Torwegge.

**TECHNICAL DETAILS:**

- Super-strength steel.
- HW head with precision balanced centre point.
- 2 precision ground cutting edges [Z2].
- 2 ground spurs [V2].
- 4 spiral flutes.

**APPLICATION:**

used on boring machines equipped with chucks. Used to drill blind holes in solid wood, wood composites, plastic and laminated materials.

## Dowel Drills with Threaded Shank



### 352-353

**HW Z2 V2 RH LH**

D mm	I mm	LB mm	S mm		ORDER NO. Right-hand rotation	ORDER NO. Left-hand rotation
5	30	45	M8/9	10	<b>352.050.11</b>	<b>352.050.12</b>
6	30	45	M8/9	10	<b>352.060.11</b>	<b>352.060.12</b>
8	30	45	M8/9	10	<b>352.080.11</b>	<b>352.080.12</b>
10	30	45	M8/9	10	<b>352.100.11</b>	<b>352.100.12</b>
12	30	45	M8/9	10	<b>352.120.11</b>	<b>352.120.12</b>

5	40	55	M8/9	10	<b>353.050.11</b>	<b>353.050.12</b>
6	40	55	M8/9	10	<b>353.060.11</b>	<b>353.060.12</b>
8	40	55	M8/9	10	<b>353.080.11</b>	<b>353.080.12</b>
10	40	55	M8/9	10	<b>353.100.11</b>	<b>353.100.12</b>
12	40	55	M8/9	10	<b>353.120.11</b>	<b>353.120.12</b>

**FOR USE ON THE FOLLOWING MACHINES:**

Masterwood (Zangheri & Boschetti)  
Morbidelli, Nottmeyer (new design)

**TECHNICAL DETAILS:**

- Super-strength steel.
- HW head with precision balanced centre point.
- 2 precision ground cutting edges [Z2].
- 2 ground spurs [V2].
- 4 spiral flutes.

**APPLICATION:**

used on boring machines equipped with chucks. Used to drill blind holes in solid wood, wood composites, plastic and laminated materials.



# BITS FOR HAND POWER TOOLS

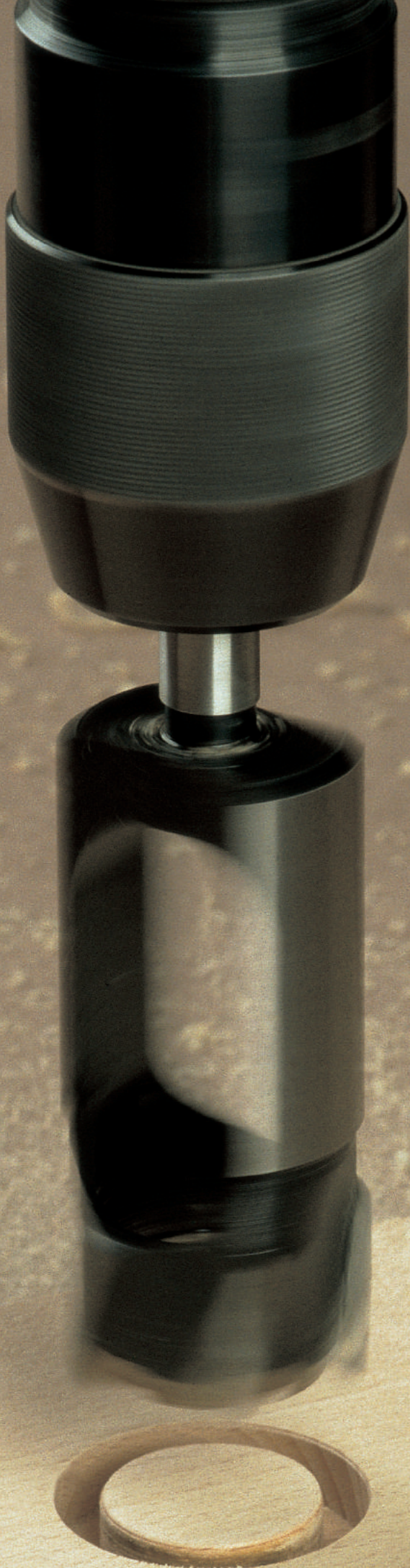

<b>PRODUCTS</b>	<b>PAGE</b>
Adapters	<b>318-319</b>
Interchangeable Boring Bits	<b>319</b>
Boring Bits	<b>320-323</b>
Chisel & Bit Sets	<b>323</b>
Plug Cutters & Sets	<b>324-325</b>
Forstner Bits	<b>326</b>
Rosette Cutters	<b>327</b>
Auger & Brad Point Bits	<b>328</b>
Bits for Mafell® & Festool® Machines	<b>329</b>
Brad Point Bits & Sets	<b>330-331</b>
Drill Bits for ANUBA Hinges	<b>331</b>
Countersinks & Drills	<b>332-335</b>





Adapters



**509-532-533** ...with parallel shank for interchangeable bits

**RH LH**

S mm	LB mm			ORDER NO. Right-hand rotation	ORDER NO. Left-hand rotation
8x30	35		10	<b>532.080.01</b>	
9,5x30	35		10	<b>532.095.01</b>	
10x50	60		1	<b>533.100.01</b>	<b>533.100.02</b>
12x30	35		10	<b>532.120.01</b>	
13x50	100		1	<b>509.130.01</b>	<b>509.130.02</b>
16x50	100		1	<b>509.160.01</b>	<b>509.160.02</b>

For use with the following parts: 501 HW

**TECHNICAL DETAILS:**

- Super strength steel.
- Parallel shank with driving flat and adjustable screw length.

**APPLICATION:**

used on boring machines with Adapter chucks.

Adapters

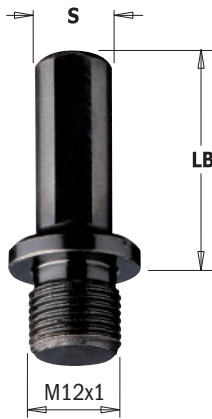

**511** ...with parallel shank for quick change drills

**RH LH**

S mm	LB mm		ORDER NO. Right-hand rotation	ORDER NO. Left-hand rotation
10x20 (with driving flat and screw)	27	10	<b>511.270.01</b>	<b>511.270.02</b>
10x35 (with driving flat and screw)	40	10	<b>511.400.01</b>	<b>511.400.02</b>

For use with the following parts: 501 HW

**TECHNICAL DETAILS:**

- Super strength steel.
- Parallel shank with driving flat and adjustable screw length.

**APPLICATION:**

used on boring machines with Adapter chucks.



Adapters



**506**

**RH LH**

S mm	LB mm		ORDER NO. Right-hand rotation	ORDER NO. Left-hand rotation
M10/11x4	15	1	<b>506.150.01</b>	<b>506.150.02</b>
M10/11x4	25	1	<b>506.250.01</b>	<b>506.250.02</b>
M10/11x4	35	1	<b>506.350.01</b>	<b>506.350.02</b>

For use with the following parts: 501 HW

**TECHNICAL DETAILS:**

- Super strength steel.
- Parallel shank with driving flat and adjustable screw length.

**APPLICATION:**

used on boring machines with Adapter chucks.



**503**

S mm	LB mm			ORDER NO. Right-hand rotation	ORDER NO. Left-hand rotation
M10/30°	25		1	<b>503.250.01</b>	<b>503.250.02</b>
M10/30°	35		1	<b>503.350.01</b>	<b>503.350.02</b>
M10/30°	45		1	<b>503.450.01</b>	<b>503.450.02</b>

For use with the following parts: 501 HW

**TECHNICAL DETAILS:**

- Super strength steel.
- Parallel shank with driving flat and adjustable screw length

**APPLICATION:**

used on boring machines with Adapter chucks.



**534**



S			ORDER NO. Right-hand rotation
MK2/Ø20x14F.x1"		1	<b>534.020.01</b>
MK2/M30x1,5		1	<b>534.030.01</b>

For use with the following parts: 501 HW

**TECHNICAL DETAILS:**

- Super strength steel.

**APPLICATION:**

used on CNC machines or hand-held routers equipped with Adapter chucks.

Interchangeable Boring Bits with Threaded Shank

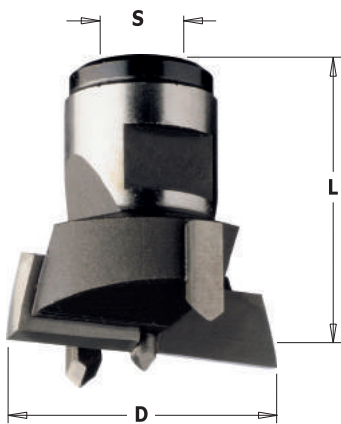

**501**



D mm	L mm	S mm		ORDER NO. Right-hand rotation	ORDER NO. Left-hand rotation
20	30	M12x1	1	<b>501.200.11</b>	<b>501.200.12</b>
22	30	M12x1	1	<b>501.220.11</b>	<b>501.220.12</b>
24	30	M12x1	1	<b>501.240.11</b>	<b>501.240.12</b>
25	30	M12x1	1	<b>501.250.11</b>	<b>501.250.12</b>
26	30	M12x1	1	<b>501.260.11</b>	<b>501.260.12</b>
30	30	M12x1	1	<b>501.300.11</b>	<b>501.300.12</b>
32	30	M12x1	1	<b>501.320.11</b>	<b>501.320.12</b>
34	30	M12x1	1	<b>501.340.11</b>	<b>501.340.12</b>
35	30	M12x1	1	<b>501.350.11</b>	<b>501.350.12</b>
36	30	M12x1	1	<b>501.360.11</b>	<b>501.360.12</b>
38	30	M12x1	1	<b>501.380.11</b>	<b>501.380.12</b>
40	30	M12x1	1	<b>501.400.11</b>	<b>501.400.12</b>
45	30	M12x1	1	<b>501.450.11</b>	<b>501.450.12</b>
50	30	M12x1	1	<b>501.500.11</b>	<b>501.500.12</b>
55	30	M12x1	1	<b>501.550.11</b>	<b>501.550.12</b>
60	30	M12x1	1	<b>501.600.11</b>	<b>501.600.12</b>

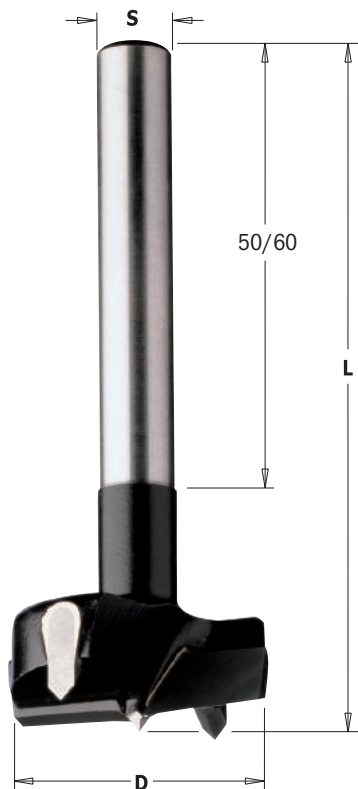

## 512

D mm	L mm	S mm		ORDER NO. Right-hand rotation
14	90	10x60	10	<b>512.140.11</b>
15	90	10x60	10	<b>512.150.11</b>
16	90	10x60	10	<b>512.160.11</b>
17	90	10x60	10	<b>512.170.11</b>
18	90	10x60	10	<b>512.180.11</b>
19	90	10x60	10	<b>512.190.11</b>
20	90	10x60	10	<b>512.200.11</b>
21	90	10x60	10	<b>512.210.11</b>
22	90	10x60	10	<b>512.220.11</b>
23	90	10x60	10	<b>512.230.11</b>
24	90	10x60	10	<b>512.240.11</b>
25	90	10x60	10	<b>512.250.11</b>
26	90	10x60	10	<b>512.260.11</b>
27	90	10x60	10	<b>512.270.11</b>
28	90	10x60	10	<b>512.280.11</b>
29	90	10x60	10	<b>512.290.11</b>
30	90	10x60	10	<b>512.300.11</b>
31	90	10x60	10	<b>512.310.11</b>
32	90	10x60	10	<b>512.320.11</b>
33	90	10x60	10	<b>512.330.11</b>
34	90	10x60	10	<b>512.340.11</b>
35	90	10x60	10	<b>512.350.11</b>
38	90	10x60	10	<b>512.380.11</b>
40	90	10x60	10	<b>512.400.11</b>
42	90	10x60	10	<b>512.420.11</b>
45	90	10x50	10	<b>512.450.11</b>
48	90	10x50	10	<b>512.480.11</b>
50	90	10x50	10	<b>512.500.11</b>
55	90	10x50	5	<b>512.550.11</b>
58	90	10x50	5	<b>512.580.11</b>
60	90	10x50	5	<b>512.600.11</b>

### TECHNICAL DETAILS:

- Super strength steel.
- HW precision balanced centre point.
- 2 HW precision ground cutting edges [Z2].
- 2 HW negatively ground spurs [V2].
- Parallel shank.

### APPLICATION:

used for drilling blind holes in solid wood, wood composites and plastic laminate materials.  
**Ideal for hinges.**

## 5-Piece Boring Bit Set for Hinges



## 512.001.01

The perfect set for hinge work and other related applications. Machined from special high speed steel with micrograin carbide tips, these bits are available in diameters of 15, 20, 25, 30 and 35mm. Safely packaged in a solid plastic box with glass front for easy storage and inventory.

### TECHNICAL DETAILS:

- Super strength steel.
- HW precision balanced centre point.
- 2 HW precision ground cutting edges [Z2].
- 2 HW negatively ground spurs [V2].
- Parallel shank.

### APPLICATION:

used for drilling blind holes in solid wood, wood composites and plastic laminated materials.  
**Ideal for hinges.**

DESCRIPTION	S mm	L mm	BIT DIAMETER mm		ORDER NO. Right-hand rotation
5-Piece Boring Bit Set for Hinges	10	90	15-20-25-30-35	5	<b>512.001.01</b>

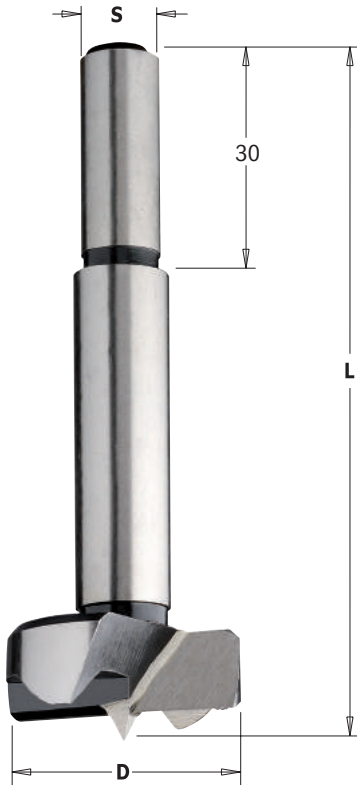

## 512

SP Z2 V2 RH

D mm	L mm	S mm		ORDER NO. Right-hand rotation
8	90	10x30	10	512.081.31
10	90	10x30	10	512.101.31
12	90	10x30	10	512.121.31
14	90	10x30	10	512.141.31
15	90	10x30	10	512.151.31
16	90	10x30	10	512.161.31
18	90	10x30	10	512.181.31
20	90	10x30	10	512.201.31
22	90	10x30	10	512.221.31
24	90	10x30	10	512.241.31
25	90	10x30	10	512.251.31
26	90	10x30	10	512.261.31
28	90	10x30	10	512.281.31
30	90	10x30	10	512.301.31
32	90	10x30	10	512.321.31
34	90	10x30	10	512.341.31
35	90	10x30	10	512.351.31
38	90	10x30	10	512.381.31
40	90	10x30	10	512.401.31
45	90	10x30	10	512.451.31
50	90	10x30	10	512.501.31

**TECHNICAL DETAILS:**

- SP steel.
- Precision balanced centre point.
- 2 spurs [V2].
- 2 precision ground cutting edges [Z2].
- Long-lasting cutting performance.
- Parallel shank.

**APPLICATION:**

used for drilling blind holes in softwood. **Ideal for hinges.**

## 5-Piece Boring Bit Set for Hinges



## 512.001.00

SP Z2 V2 RH

The perfect set for hinge work and other related applications. Machined from special high speed steel, these bits are available in diameters of 15, 20, 25, 30 and 35mm. Precisely ground, sharpened with round shanks and safely packaged in a solid plastic box with glass front for easy storage and inventory.

**TECHNICAL DETAILS:**

- SP steel.
- Precision balanced centre point.
- 2 spurs [V2].
- 2 precision ground cutting edges [Z2].
- Long-lasting cutting performance.

**APPLICATION:**

used for drilling blind holes in softwood. **Ideal for hinges.**

DESCRIPTION	S mm	L mm	BIT DIAMETER mm		ORDER NO. Right-hand rotation
5-Piece Boring Bit Set for Hinges	10	90	15-20-25-30-35	5	512.001.00



HW Z2 V2 RH

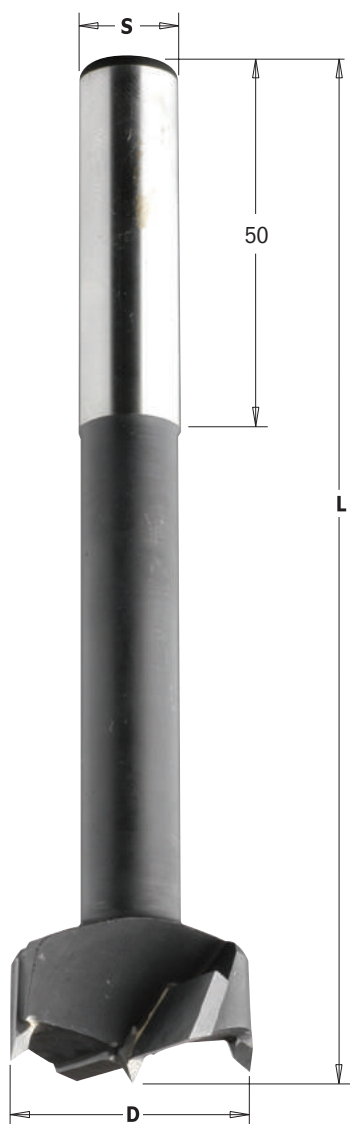

## 513

D mm	L mm	S mm		ORDER NO. Right-hand rotation
15	120	13	1	<b>513.150.11</b>
16	120	13	1	<b>513.160.11</b>
18	120	13	1	<b>513.180.11</b>
20	120	13	1	<b>513.200.11</b>
22	125	13	1	<b>513.220.11</b>
25	125	13	1	<b>513.250.11</b>
26	125	13	1	<b>513.260.11</b>
28	130	13	1	<b>513.280.11</b>
30	130	13	1	<b>513.300.11</b>
35	130	13	1	<b>513.350.11</b>
40	130	13	1	<b>513.400.11</b>
45	130	13	1	<b>513.450.11</b>
50	130	13	1	<b>513.500.11</b>
55	140	13	1	<b>513.550.11</b>
60	140	13	1	<b>513.600.11</b>

## 514

D mm	L mm	S mm		ORDER NO. Right-hand rotation
15	120	16	1	<b>514.150.11</b>
16	120	16	1	<b>514.160.11</b>
18	120	16	1	<b>514.180.11</b>
20	120	16	1	<b>514.200.11</b>
22	125	16	1	<b>514.220.11</b>
25	125	16	1	<b>514.250.11</b>
26	125	16	1	<b>514.260.11</b>
28	130	16	1	<b>514.280.11</b>
30	130	16	1	<b>514.300.11</b>
32	130	16	1	<b>514.320.11</b>
35	130	16	1	<b>514.350.11</b>
40	130	16	1	<b>514.400.11</b>
45	130	16	1	<b>514.450.11</b>
50	130	16	1	<b>514.500.11</b>
55	140	16	1	<b>514.550.11</b>
60	140	16	1	<b>514.600.11</b>

### TECHNICAL DETAILS:

- Super strength steel.
- HW precision balanced centre point.
- 2 HW precision ground cutting edges [Z2].
- 2 HW negatively ground spurs [V2].
- Parallel shank.

### APPLICATION:

used for drilling blind holes in solid wood, wood composites and plastic laminated materials.  
**Ideal for hinges.**



## 392

**HW** **Z2** **V2** **RH**

D mm	L mm	S mm		ORDER NO. Right-hand rotation
15	60	8	10	<b>392.150.11</b>
20	60	8	10	<b>392.200.11</b>
25	60	8	10	<b>392.250.11</b>
26	60	8	10	<b>392.260.11</b>
30	60	8	10	<b>392.300.11</b>
35	60	8	10	<b>392.350.11</b>
35	60	12,7	10	<b>392.351.11</b>
40	60	8	10	<b>392.400.11</b>

### TECHNICAL DETAILS:

- Super strength steel.
- HW precision balanced centre point.
- 2 HW precision ground cutting edges [Z2].
- 2 HW negatively ground spurs [V2].
- Parallel shank.
- Right-hand rotation (RH).

### APPLICATION:

for use on drilling machines and hand-held routers in solid wood, wood composites and plastic laminated materials.

**Ideal for hinges and blind holes.**

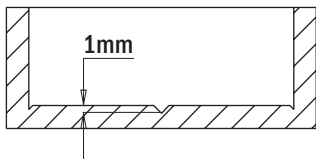

New construction with 1mm centre point

# Mortise Chisel & Bit Sets



## 543

**HSS** **Z1** **RH**

mm	D inches	mm	S inches		ORDER NO. Right-hand rotation
6,35	1/4	19	3/4	1	<b>543.064.51</b>
8	5/16	19	3/4	1	<b>543.079.51</b>
9,5	3/8	19	3/4	1	<b>543.095.51</b>
12,7	1/2	19	3/4	1	<b>543.127.51</b>
15,8	5/8	19	3/4	1	<b>543.158.51</b>
19	3/4	19	3/4	1	<b>543.190.51</b>

It's tough to beat the "old faithful" mortise and tenon joint for strength and accuracy, even with all the other joining options in the world of woodworking.

It isn't the easiest joint to make, but for sure it helps to have the best quality tools in your shop. That's why we've added a new selection of chisel and bit sets in all the popular sizes 6,35mm (1/4") to 19mm (3/4") diameter.

These sets are for use on any standard drill press mortising attachment of mortising machines.



Sample of Chisel Mortiser

Plug Cutters

**SP RH**



**529**

d mm	D mm	L mm	S mm	Z		ORDER NO. Right-hand rotation
8	18	140	13	4	5	<b>529.080.31</b>
10	20	140	13	4	5	<b>529.100.31</b>
12	24	140	13	4	5	<b>529.120.31</b>
14	26	140	13	4	5	<b>529.140.31</b>
15	27	140	13	4	5	<b>529.150.31</b>
16	28	140	13	4	5	<b>529.160.31</b>
18	30	140	13	4	5	<b>529.180.31</b>
20	32	140	13	4	5	<b>529.200.31</b>
22	34	140	13	5	5	<b>529.220.31</b>
25	37	140	13	5	5	<b>529.250.31</b>
30	42	140	13	5	5	<b>529.300.31</b>
32	44	140	13	5	5	<b>529.320.31</b>
35	47	160	16	6	2	<b>529.350.31</b>
40	52	160	16	6	2	<b>529.400.31</b>
45	57	160	16	6	2	<b>529.450.31</b>
50	62	160	16	6	2	<b>529.500.31</b>

d inches	D inches	L inches	S inches	Z		ORDER NO. Right-hand rotation
3/8	49/64	5-1/2	1/2	4	5	<b>529.095.31</b>
1/2	61/64	5-1/2	1/2	4	5	<b>529.127.31</b>
5/8	1-7/64	5-1/2	1/2	4	5	<b>529.158.31</b>
3/4	1-7/32	5-1/2	1/2	4	5	<b>529.191.31</b>
7/8	1-11/32	5-1/2	1/2	4	5	<b>529.222.31</b>
1	1-15/32	5-1/2	1/2	5	5	<b>529.254.31</b>
1-1/4	1-19/32	5-1/2	1/2	5	5	<b>529.317.31</b>
1-3/8	1-27/32	6-5/16	5/8	6	2	<b>529.349.31</b>
1-1/2	1-31/32	6-5/16	5/8	6	2	<b>529.381.31</b>
1-5/8	2-3/32	6-5/16	5/8	6	2	<b>529.413.31</b>
1-3/4	2-7/32	6-5/16	5/8	6	2	<b>529.445.31</b>
2	2-15/32	6-5/16	5/8	6	2	<b>529.508.31</b>

Use our D=16mm bushing to increase the 13mm shank (order no. 799.130.00 on page 395)

**TECHNICAL DETAILS:**  
- SP steel.  
- Long lasting cutter performance.

**APPLICATION:**  
used to make plugs in hard and soft woods.

D mm	D inches	Max RPM Softwood	Max RPM Hardwood
< Ø16	5/8	1000	500
< Ø40	1-37/64	500	300
> Ø40	1-37/64	200	150

Plug Cutters



**530**

**HSS Z4 RH**

D mm	S		ORDER NO. Right-hand rotation
6,2	Ø21x14F.1"	1	<b>530.062.51</b>
8	Ø21x14F.1"	1	<b>530.080.51</b>
8,2	Ø21x14F.1"	1	<b>530.082.51</b>
10	Ø21x14F.1"	1	<b>530.100.51</b>
10,2	Ø21x14F.1"	1	<b>530.102.51</b>
12	Ø21x14F.1"	1	<b>530.120.51</b>
12,2	Ø21x14F.1"	1	<b>530.122.51</b>

**TECHNICAL DETAILS:**  
- Super strength HSS steel.  
- 4 precision ground cutting edges [Z4].  
- Long lasting cutter performance.

**APPLICATION:**  
used for cutting dowels.

**REMARK:**  
available on request.

## 500.001/02/03

**SP RH**

We offer a wide range of boring bits and plug cutters in the most popular diameters. If you need to bore or to make plugs in soft-wood these sets are exactly what you need!

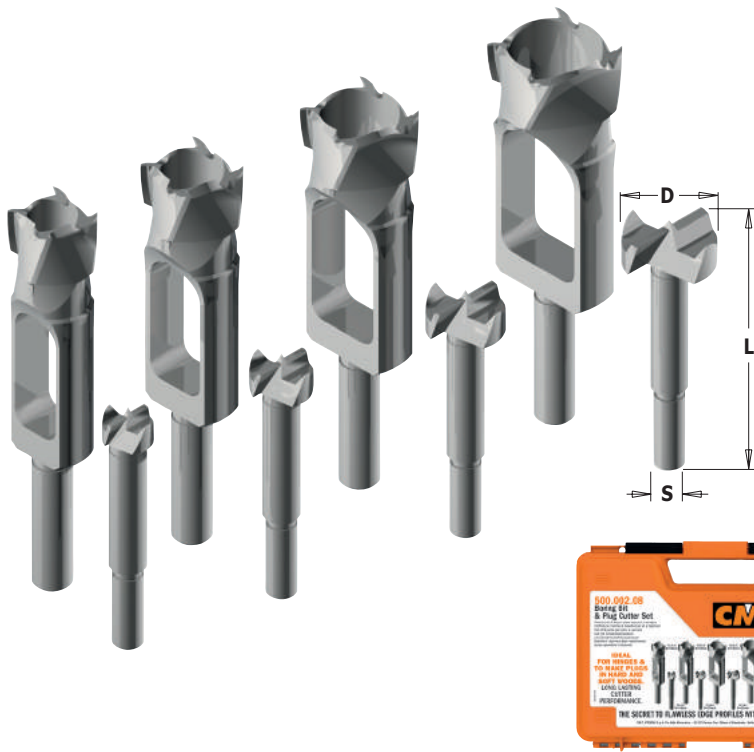

### 500.001.08 Boring Bit & Plug Cutter Set

SET CONTAINS	D mm	L mm	S mm	ORDER NO. Right-hand rotation
Boring Bit with Parallel Shank	8	90	10	<b>512.081.31</b>
Boring Bit with Parallel Shank	10	90	10	<b>512.101.31</b>
Boring Bit with Parallel Shank	12	90	10	<b>512.121.31</b>
Boring Bit with Parallel Shank	15	90	10	<b>512.151.31</b>
Plug Cutter	8	140	13	<b>529.080.31</b>
Plug Cutter	10	140	13	<b>529.100.31</b>
Plug Cutter	12	140	13	<b>529.120.31</b>
Plug Cutter	15	140	13	<b>529.150.31</b>

### 500.002.08 Boring Bit & Plug Cutter Set

SET CONTAINS	D mm	L mm	S mm	ORDER NO. Right-hand rotation
Boring Bit with Parallel Shank	16	90	10	<b>512.161.31</b>
Boring Bit with Parallel Shank	20	90	10	<b>512.201.31</b>
Boring Bit with Parallel Shank	25	90	10	<b>512.251.31</b>
Boring Bit with Parallel Shank	30	90	10	<b>512.301.31</b>
Plug Cutter	16	140	13	<b>529.160.31</b>
Plug Cutter	20	140	13	<b>529.200.31</b>
Plug Cutter	25	140	13	<b>529.250.31</b>
Plug Cutter	30	140	13	<b>529.300.31</b>

### 500.003.08 Boring Bit & Plug Cutter Set

SET CONTAINS	D mm	L mm	S mm	ORDER NO. Right-hand rotation
Boring Bit with Parallel Shank	15	90	10	<b>512.151.31</b>
Boring Bit with Parallel Shank	20	90	10	<b>512.201.31</b>
Boring Bit with Parallel Shank	25	90	10	<b>512.251.31</b>
Boring Bit with Parallel Shank	30	90	10	<b>512.301.31</b>
Plug Cutter	15	140	13	<b>529.150.31</b>
Plug Cutter	20	140	13	<b>529.200.31</b>
Plug Cutter	25	140	13	<b>529.250.31</b>
Plug Cutter	30	140	13	<b>529.300.31</b>



# Forstner Bits

**SP Z2 V2 RH**



## 537

D mm	L mm	S mm		ORDER NO. Right-hand rotation
10	90	8	10	<b>537.100.31</b>
12	90	8	10	<b>537.120.31</b>
14	90	8	10	<b>537.140.31</b>
15	90	8	10	<b>537.150.31</b>
16	90	8	10	<b>537.160.31</b>
18	90	8	10	<b>537.180.31</b>
20	90	8	10	<b>537.200.31</b>
22	90	8	10	<b>537.220.31</b>
24	90	8	10	<b>537.240.31</b>
25	90	8	10	<b>537.250.31</b>
26	90	8	10	<b>537.260.31</b>
28	90	8	10	<b>537.280.31</b>
30	90	8	10	<b>537.300.31</b>
32	90	10	10	<b>537.320.31</b>
35	90	10	10	<b>537.350.31</b>
38	90	10	10	<b>537.380.31</b>
40	90	10	10	<b>537.400.31</b>
45	90	10	10	<b>537.450.31</b>
50	90	10	10	<b>537.500.31</b>
55	90	10	5	<b>537.550.31</b>
68	157	12,7	5	<b>537.680.31</b>

D inches	L inches	S inches		ORDER NO. Right-hand rotation
1/4	3-35/64	3/8	10	<b>537.064.31</b>
3/8	3-35/64	3/8	10	<b>537.095.31</b>
1/2	3-35/64	3/8	10	<b>537.127.31</b>
5/8	3-35/64	3/8	10	<b>537.158.31</b>
3/4	3-35/64	3/8	10	<b>537.190.31</b>
7/8	3-35/64	3/8	10	<b>537.222.31</b>
1	3-35/64	3/8	10	<b>537.254.31</b>
1-1/8	3-35/64	3/8	10	<b>537.285.31</b>
1-1/4	3-35/64	3/8	10	<b>537.317.31</b>
1-3/8	3-35/64	3/8	10	<b>537.349.31</b>
1-1/2	3-35/64	3/8	10	<b>537.381.31</b>
1-5/8	3-35/64	3/8	10	<b>537.413.31</b>
1-3/4	3-35/64	3/8	10	<b>537.445.31</b>
1-7/8	3-35/64	3/8	10	<b>537.476.31</b>
2	3-35/64	3/8	10	<b>537.508.31</b>
2-1/8	3-35/64	3/8	5	<b>537.540.31</b>

toothed rim  $\geq \varnothing 25\text{mm}$

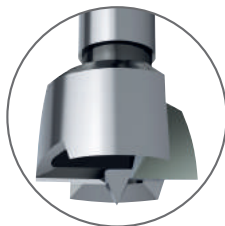

standard rim  $< \varnothing 25\text{mm}$

### STANDARD RIM AND TOOTHED RIM:

Standard rims provide better guidance but tend to overheat. To overcome heat the larger diameters ( $\geq \varnothing 25\text{mm}$ ) are designed with toothed rims.

### TECHNICAL DETAILS:

- Super strength SP steel.
- Precision balanced centre point.
- 2 spurs [V2].
- 2 precision ground cutting edges [Z2].
- Long-lasting cutting performance.

### APPLICATION:

used to drill precise flat bottom holes with no chipping in any softwood thickness.

# Forstner Bit Sets

We offer a wide range of Forstner bits in the most popular diameters. These bits are available separately or in beautiful wooden sets. The high performance stagger tooth design on the bits with larger diameters allows for sharp holes with straight sides and flat bottoms. Bits available for drill presses, electric and cordless drills. Suitable for working on any type of softwood.

**SP Z2 V2 RH**

## 537.000.16

- 537.000.04**
- 537.000.05**
- 537.000.07**
- 537.000.12**



DESCRIPTION	SHANK	BIT DIAMETER		ORDER NO. Right-hand rotation
5 pcs. Router Bit Set in clamshell	Ø8-10mm	Ø15-20-25-30-35mm	5	<b>537.000.05</b>
12 pcs. Router Bit Set in clamshell	Ø8-10mm	Ø10-12-14-15-16-18-20-22-25-26-30-35mm	6	<b>537.000.12</b>
4 pcs. Router Bit Set in clamshell	Ø3/8"	Ø1/4" - 1/2" - 3/4" - 1"	5	<b>537.000.04</b>
7 pcs. Router Bit Set in clamshell	Ø3/8"	Ø1/4" - 3/8" - 1/2" - 5/8" - 3/4" - 7/8" - 1"	6	<b>537.000.07</b>
16 pcs. Router Bit Set in plastic box	Ø3/8"	Ø1/4" - 3/8" - 1/2" - 5/8" - 3/4" - 7/8" - 1" - 1-1/8" - 1-1/4" - 1-3/8" - 1-1/2" - 1-5/8" - 1-3/4" - 1-7/8" - 2" - 2-1/8"	8	<b>537.000.16</b>



## 531

**HW** **Z2** **RH**

D mm	L mm	S mm	Max RPM		ORDER NO. Right-hand rotation
54	73,5	9,5	1500	10	<b>531.541</b>
54	71,3	9,5	1500	10	<b>531.542</b>
54	67,3	9,5	1500	10	<b>531.543</b>
54	72,3	9,5	1500	10	<b>531.544</b>
70	76,5	9,5	1000	5	<b>531.701</b>
70	74	9,5	1000	5	<b>531.702</b>

**TECHNICAL DETAILS:**

- Super strength steel.
- 2 HW precision ground cutting edges [Z2].
- Parallel exagonal shank.
- Right-hand rotation (RH).

**APPLICATION:**

to be used on drill presses and drilling power tools at low RPMs (see table). We recommend clamping your workpiece mechanically during boring operations.

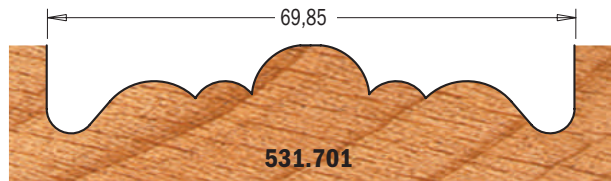
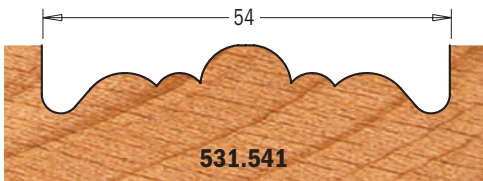

Drawings are 1:1 scale



**531.541**  
**531.701**

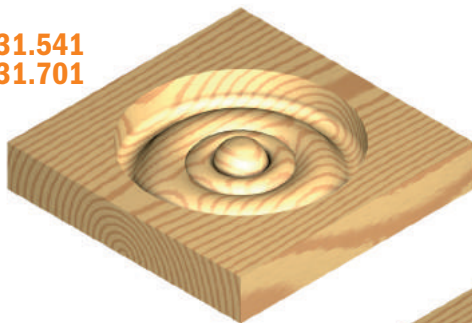

**531.542**  
**531.702**

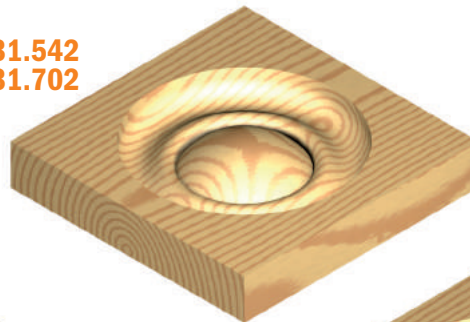

**531.543**

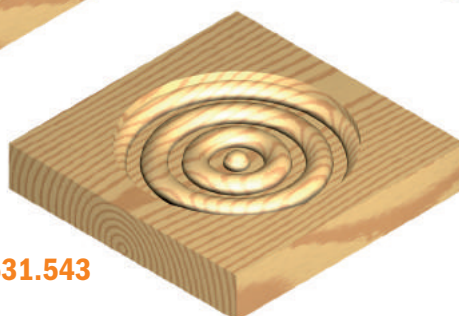

**531.544**

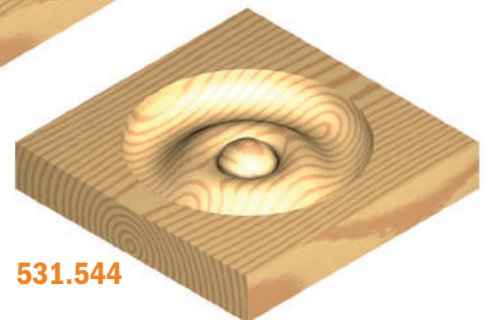

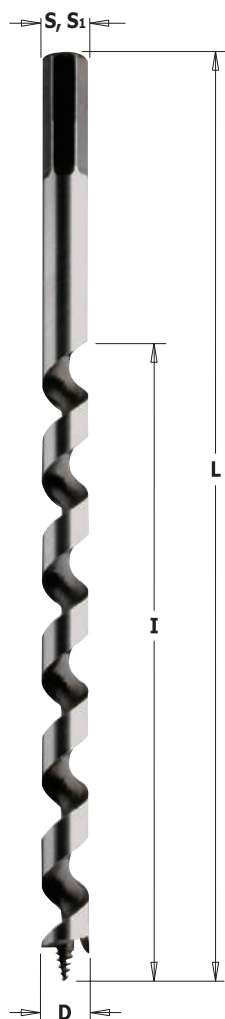

## 542-535

**HSS** **Z1** **V1** **RH**

D mm	I mm	L mm	S	S <sub>1</sub> mm	RPM max		ORDER NO. Right-hand rotation
6	155	230	Hexagonal	6	800 ~ 1400	1	<b>542.060.51</b>
8	155	230	Hexagonal	6,35	800 ~ 1400	1	<b>542.080.51</b>
10	155	230	Hexagonal	9	600 ~ 1200	1	<b>542.100.51</b>
12	155	230	Hexagonal	12	600 ~ 1100	1	<b>542.120.51</b>
14	155	230	Hexagonal	12	600 ~ 1000	1	<b>542.140.51</b>
16	155	230	Hexagonal	12	500 ~ 900	1	<b>542.160.51</b>
18	155	230	Hexagonal	12	500 ~ 800	1	<b>542.180.51</b>
20	155	230	Hexagonal	12	400 ~ 700	1	<b>542.200.51</b>
8	360	460	Hexagonal	6,55	800 ~ 1000	1	<b>535.080.51</b>
10	360	460	Hexagonal	9	600 ~ 1000	1	<b>535.100.51</b>
12	360	460	Hexagonal	12	600 ~ 1000	1	<b>535.120.51</b>
14	360	460	Hexagonal	12	500 ~ 900	1	<b>535.140.51</b>
16	360	460	Hexagonal	12	500 ~ 900	1	<b>535.160.51</b>
18	360	460	Hexagonal	12	450 ~ 800	1	<b>535.180.51</b>
20	360	460	Hexagonal	12	400 ~ 700	1	<b>535.200.51</b>

### TECHNICAL DETAILS:

- Super strength HSS steel.
- Precision balanced centre point.
- 1 precision ground cutting edge [Z1].
- 1 spiral flute.
- 1 spur [V1].
- Long-lasting cutting performance.

### APPLICATION:

used for drilling deep holes in soft and hardwood.



## Brad Point Bits

### 540

**HW** **Z2** **V2** **RH**

D mm	L mm	S mm		ORDER NO. Right-hand rotation
5	90	8x30	1	<b>540.050.11</b>
6	90	8x30	1	<b>540.060.11</b>
8	90	8x30	1	<b>540.080.11</b>
10	90	8x30	1	<b>540.100.11</b>
12	90	8x30	1	<b>540.120.11</b>

### TECHNICAL DETAILS:

- Super strength steel.
- HW head with precision balanced centre point.
- 2 precision ground cutting edges [Z2].
- 2 negatively ground spurs [V2].
- 2 spiral flutes

### APPLICATION:

for use on hand-held router to drill blind holes in solid wood, wood composites or plastic laminates.

## 541 Stop Collars

D mm	PACK QTY.	ORDER NO.
5	10	<b>541.050.00</b>
6	10	<b>541.060.00</b>
8	10	<b>541.080.00</b>
10	10	<b>541.100.00</b>
12	10	<b>541.120.00</b>

### Spare parts

990.002.00	991.062.00
990.002.00	991.062.00
990.002.00	991.062.00
990.002.00	991.062.00
990.002.00	991.062.00

### Negatively Ground Spurs

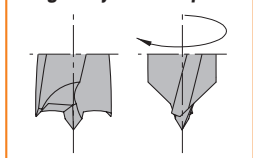

Stop collars with precision clamping nut and key for quick and easy assembly.



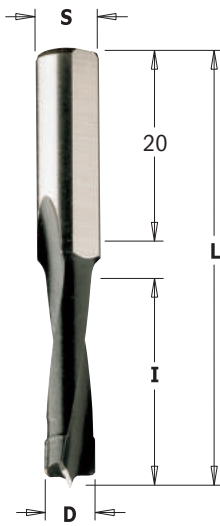

**312**

**HW Z2 RH**

D mm	I mm	L mm	S mm		ORDER NO. Right-hand rotation
4	30	58	8	10	<b>312.040.11</b>
5	30	58	8	10	<b>312.050.11</b>
6	30	58	8	10	<b>312.060.11</b>
8	30	58	8	10	<b>312.080.11</b>
10	30	58	8	10	<b>312.100.11</b>
12	30	58	8	10	<b>312.120.11</b>
14	30	58	8	10	<b>312.140.11</b>
16	30	58	8	10	<b>312.160.11</b>

These drill bits are made with high-strength steel in order to work with high speed rotation. They are perfect for boring all materials like solid wood, wood and composites, plastic and laminated with **hand-held routers and MAFELL® machine model DD40.**

**Spare parts** 990.003.00  
**Optional** 990.088.00

**TECHNICAL DETAILS:**

- Super strength steel.
- Spiral portion coated with black P.T.F.E.
- HW precision balanced centre point.
- 2 HW precision ground cutting edges [Z2].
- 2 spiral flutes.
- Parallel shank with driving flat and length adjusting screw.

**Sharpening with chamfer**

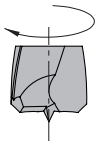

Router Bits for Domino® Joining Machines by Festool®



**380**

**HW HWM Z2 RH**

D mm	I mm	L mm	S mm	FESTOOL®		ORDER NO. Right-hand rotation
• 4	11	38	M6x0,75	DF500	10	<b>380.040.11</b>
5	20	49	M6x0,75	DF500	10	<b>380.050.11</b>
6	28	49	M6x0,75	DF500	10	<b>380.060.11</b>
8	28	49	M6x0,75	DF500	10	<b>380.080.11</b>
10	28	49	M6x0,75	DF500	10	<b>380.100.11</b>
8	50	90	M8x1	DF700	10	<b>380.081.11</b>
10	70	90	M8x1	DF700	10	<b>380.101.11</b>
12	70	90	M8x1	DF700	10	<b>380.121.11</b>
14	70	90	M8x1	DF700	10	<b>380.141.11</b>

• **HWM**

**TECHNICAL DETAILS:**

- Premium quality super-strength steel.
- Spiral portion coating with black P.T.F.E.
- Extra-fine micrograin carbide spiral portion.
- 2 cutting edges [Z2].
- 2 spiral flutes.

**APPLICATION:**

for use on "Domino®" machines to rout slots on solid wood and wood composites.





# Brad Point Bits

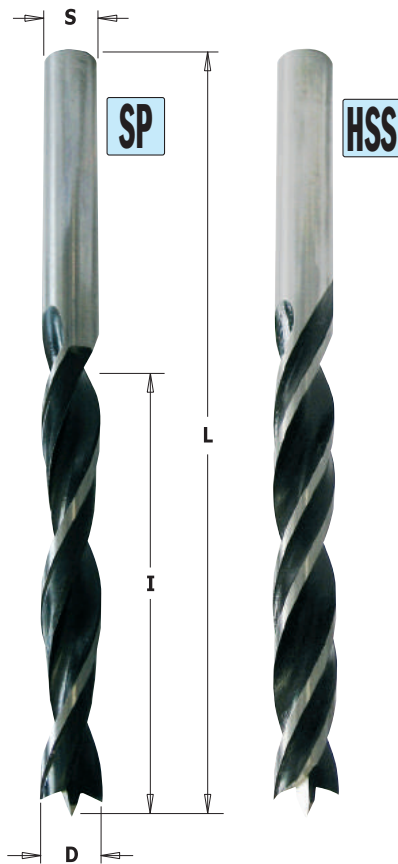

## 517

**SP HSS Z2 RH**

D mm	I mm	L mm	S mm		ORDER NO. Right-hand rotation	ORDER NO. Right-hand rotation
3	33	61	3	1	<b>517.030.31</b>	<b>517.030.51</b>
4	43	75	4	1	<b>517.040.31</b>	<b>517.040.51</b>
5	52	86	5	1	<b>517.050.31</b>	<b>517.050.51</b>
6	57	93	6	1	<b>517.060.31</b>	<b>517.060.51</b>
7	69	109	7	1	<b>517.070.31</b>	<b>517.070.51</b>
8	75	117	8	1	<b>517.080.31</b>	<b>517.080.51</b>
9	80	120	9	1	<b>517.090.31</b>	<b>517.090.51</b>
10	80	120	10	1	<b>517.100.31</b>	<b>517.100.51</b>
11	89	142	8	1	<b>517.110.31</b>	<b>517.110.51</b>
12	96	151	8	1	<b>517.120.31</b>	<b>517.120.51</b>
13	96	151	8	1	<b>517.130.31</b>	<b>517.130.51</b>
14	96	151	10	1	<b>517.140.31</b>	<b>517.140.51</b>
15	100	160	10	1	<b>517.150.31</b>	<b>517.150.51</b>
16	100	160	10	1	<b>517.160.31</b>	<b>517.160.51</b>
18	130	180	10	1	<b>517.180.31</b>	
20	135	200	10	1	<b>517.200.31</b>	

**SP**

**TECHNICAL DETAILS:**

- Super strength SP steel.
- Precision balanced center point.
- 2 precision ground cutting edges [Z2].
- 2 flutes.

**APPLICATION:**

used for drilling holes in softwood.

**HSS**

**TECHNICAL DETAILS:**

- Super strength HSS steel.
- Precision balanced center point.
- 2 precision ground cutting edges [Z2].
- 4 flutes.

**APPLICATION:**

used for drilling holes in soft and hardwood.

**Long-lasting cutting performance.**

# Brad Point Bit Sets



## 517

**HSS SP Z2 RH**

**5-Piece Brad Point Bit Set**

An economical collection of the five most popular sized brad points - 4, 5, 6, 8 and 10mm.

Safely packaged in a reusable plastic case for easy storage and access.

**8-Piece Brad Point Bit Set**

A complete collection of the most popular brad points in the most requested sizes - 3, 4, 5, 6, 7, 8, 9 and 10mm.

Safely packaged in a reusable plastic case for easy storage and access.

DESCRIPTION	Z	BIT DIAMETER		ORDER NO. Right-hand rotation
5-Pcs. HSS Brad Point Set	4 flutes	(Ø4-5-6-8-10mm)	50	<b>517.001.01</b>
5-Pcs. SP Brad Point Set	2 flutes	(Ø4-5-6-8-10mm)	50	<b>517.001.00</b>
8-Pcs. HSS Brad Point Set	4 flutes	(Ø3-4-5-6-7-8-9-10mm)	30	<b>517.002.01</b>
8-Pcs. SP Brad Point Set	2 flutes	(Ø3-4-5-6-7-8-9-10mm)	30	<b>517.002.00</b>

**HSS Z2 RH LH**

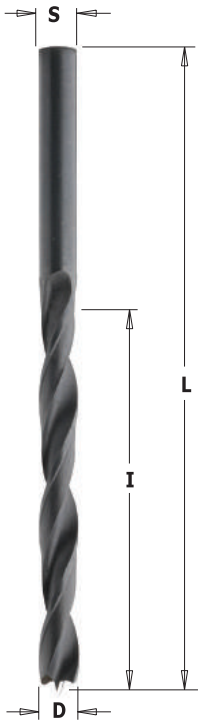

## 516

D mm	I mm	L mm	S mm		ORDER NO. Right-hand rotation	ORDER NO. Left-hand rotation
2	24	49	2	10	<b>516.020.51</b>	<b>516.020.52</b>
2,5	30	57	2,5	10	<b>516.025.51</b>	<b>516.025.52</b>
3	33	61	3	10	<b>516.030.51</b>	<b>516.030.52</b>
3,5	39	70	3,5	10	<b>516.035.51</b>	<b>516.035.52</b>
4	43	75	4	10	<b>516.040.51</b>	<b>516.040.52</b>
4,5	47	80	4,5	10	<b>516.045.51</b>	<b>516.045.52</b>
5	52	86	5	10	<b>516.050.51</b>	<b>516.050.52</b>
5,5	57	93	5,5	10	<b>516.055.51</b>	<b>516.055.52</b>
6	57	93	6	10	<b>516.060.51</b>	<b>516.060.52</b>
7	69	109	7	10	<b>516.070.51</b>	<b>516.070.52</b>
8	75	117	8	10	<b>516.080.51</b>	<b>516.080.52</b>
9	81	125	9	10	<b>516.090.51</b>	<b>516.090.52</b>
10	87	133	10	10	<b>516.100.51</b>	<b>516.100.52</b>

**TECHNICAL DETAILS:**

- Super strength steel.
- Precision balanced centre point.
- 2 precision ground cutting edges [Z2].
- 2 spiral flutes.
- Common shank and cutting diameter (S=D).

**APPLICATION:**

used for drilling holes in soft and hardwood.

# Drill Bits for ANUBA Hinges

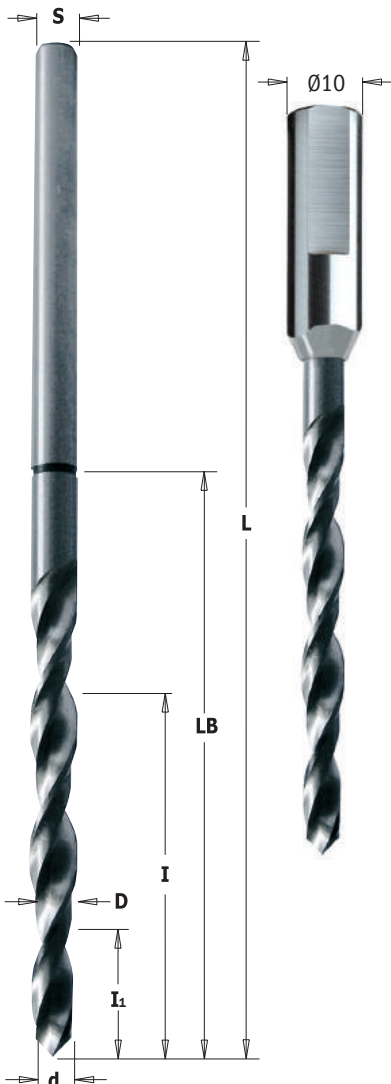

## 515

**HSS Z2 RH**

ANUBA no.	d mm	D-S mm	I <sub>1</sub> mm	I mm	LB mm	L mm		ORDER NO. Right-hand rotation
9,5	3,8	5,2	18	56	74	132	1	<b>515.095.51</b>
11	4,8	5,7	17	60	76	145	1	<b>515.110.51</b>
13	5,8	6,7	18	68	83	155	1	<b>515.130.51</b>
14,5	6,3	7,2	19	75	89	165	1	<b>515.145.51</b>
16	6,7	7,7	25	85	100	165	1	<b>515.160.51</b>
18	7,7	8,7	25	85	102	165	1	<b>515.180.51</b>
20	8,8	9,8	25	90	104	165	1	<b>515.200.51</b>

**Parallel Shank with Driving Flat**

ANUBA no.	d mm	D mm	I mm	LB mm	S mm	L mm		ORDER NO. Right-hand rotation
9	3,8	5	20	40	10x35	75	1	<b>515.091.51</b>
11	4,2	5,7	20	45	10x35	80	1	<b>515.111.51</b>
13	5,2	6,5	15	50	10x35	85	1	<b>515.131.51</b>
14	5,5	7	15	55	10x35	90	1	<b>515.141.51</b>
16	6	7,7	15	60	10x35	95	1	<b>515.161.51</b>
18	6,6	8,2	20	70	10x35	105	1	<b>515.181.51</b>
20	7,2	8,7	20	80	10x35	115	1	<b>515.201.51</b>

**TECHNICAL DETAILS:**

- Super strength steel.
- HSS steel.
- 2 HSS precision ground cutting edges [Z2].
- 2 spiral flutes.

**APPLICATION:**

used for drilling blind holes in soft and hardwood.



## Countersinks with Threaded Shank

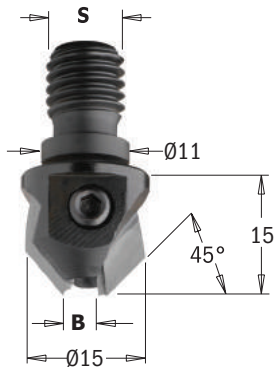

**350**

**HW** **Z2** **RH** **LH**

B mm	S mm			ORDER NO. Right-hand rotation	ORDER NO. Left-hand rotation
3	M10/Ø11x4		10	<b>350.030.11</b>	<b>350.030.12</b>
4	M10/Ø11x4		10	<b>350.040.11</b>	<b>350.040.12</b>
5	M10/Ø11x4		10	<b>350.050.11</b>	<b>350.050.12</b>

**TECHNICAL DETAILS:**

- Super strength steel.
- 2 HW precision ground cutting edges [Z2].
- Quick and easy drill change.

**APPLICATION:**

for use with spiral bits featuring parallel shank.

Spare parts



## Countersinks with Threaded Shank

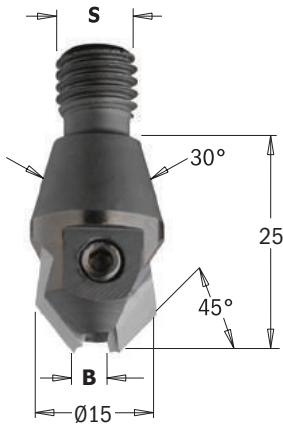

**351**

B mm	S mm			ORDER NO. Right-hand rotation	ORDER NO. Left-hand rotation
3	M10/30°		10	<b>351.030.11</b>	<b>351.030.12</b>
4	M10/30°		10	<b>351.040.11</b>	<b>351.040.12</b>
5	M10/30°		10	<b>351.050.11</b>	<b>351.050.12</b>

**TECHNICAL DETAILS:**

- Super strength steel.
- 2 HW precision ground cutting edges [Z2].
- Quick and easy drill change.

**APPLICATION:**

for use with spiral bits featuring parallel shank.

Spare parts



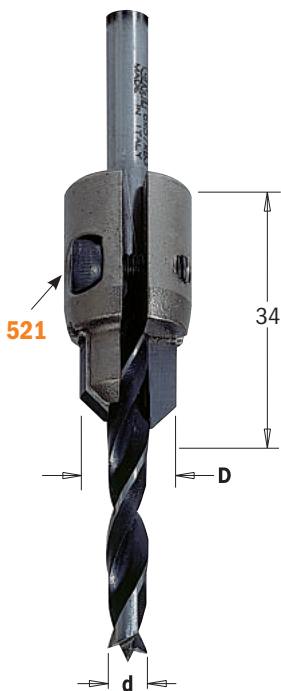

## Adjustable Countersink



**521.001**

**HW** **Z2** **RH**

d mm	D mm		ORDER NO. Right-hand rotation	Spare parts	
3 ~ 7	11 ~ 15	10	<b>521.001.11</b>	 990.061.00	 991.067.00

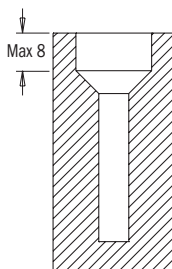

Twist drills	Overall diameter
Ø3	Ø11
Ø4	Ø12
Ø5	Ø13
Ø6	Ø14
Ø7	Ø15

**TECHNICAL DETAILS:**

- Premium quality HW.
- 2 HW precision ground cutting edges [Z2].
- Quick and easy drill change.

**APPLICATION:**

for use with spiral bits featuring parallel shank.  
**Twist drills not included.**

## Drill Bits with 45° Countersink Set

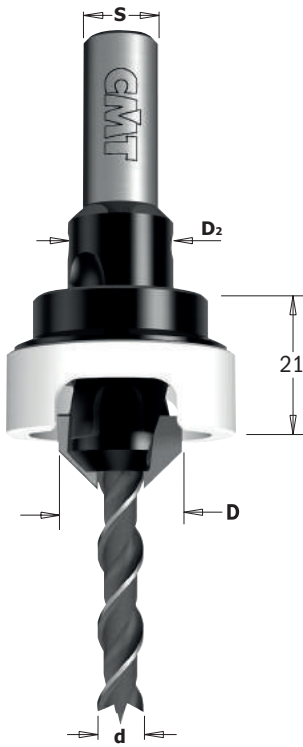

### 521A



d mm	D mm	D <sub>2</sub> mm	A	S mm		ORDER NO. Right-hand rotation
3	12	10	45°	8	10	<b>521.312.11A</b>
4	12	10	45°	8	10	<b>521.412.11A</b>
5	16	14	45°	10	10	<b>521.516.11A</b>
6	16	14	45°	10	10	<b>521.616.11A</b>

Spare parts

521.312.11	517.030.51	541.101.00
521.412.11	517.040.51	541.101.00
521.516.11	517.050.51	541.141.00
521.616.11	517.060.51	541.141.00

Spare parts 990.014.00 Screw  
991.060.00 Hex key

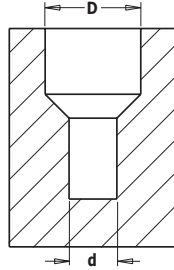

#### TECHNICAL DETAILS:

- Super strength steel.
- Countersink: 2 HW precision ground cutting edges [Z2].

#### APPLICATION:

used for drilling holes in soft, hardwood and wood composites.

Stop collars with precision clamping nut for quick and easy assembly. The Delrin® protection sleeve lets you work without leaving marks on the workpiece.

## Drill Bits with 90° Countersink Set

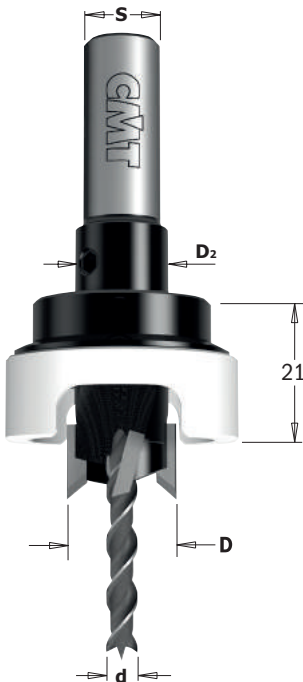

### 515A



d mm	D mm	D <sub>2</sub> mm	S mm		ORDER NO. Right-hand rotation
4	12	10	10	10	<b>515.412.11A</b>
4	14	12	10	10	<b>515.414.11A</b>
5	15	14	10	10	<b>515.515.11A</b>
6	14	12	10	10	<b>515.614.11A</b>
6	15	14	10	10	<b>515.615.11A</b>

Spare parts

515.412.11	517.040.51	541.101.00
515.414.11	517.040.51	541.121.00
515.515.11	517.050.51	541.141.00
515.614.11	517.060.51	541.121.00
515.615.11	517.060.51	541.141.00

Spare parts 990.014.00 Screw  
991.060.00 Hex key

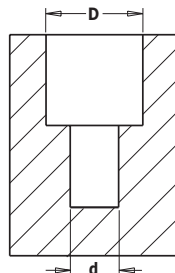

#### TECHNICAL DETAILS:

- Super strength steel.
- Countersink: 2 HW precision ground cutting edges [Z2].
- Countersink: 2 HW negatively ground spurs [V2].

#### APPLICATION:

used for drilling holes in soft, hardwood and wood composites.

Stop collars with precision clamping nut for quick and easy assembly. The Delrin® protection sleeve lets you work without leaving marks on the workpiece.

## Stop Collars with Delrin® Sleeve

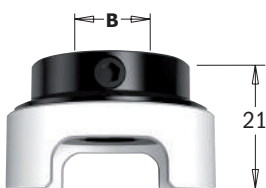

### 541

B mm		ORDER NO.
10	1	<b>541.101.00</b>
12	1	<b>541.121.00</b>
14	1	<b>541.141.00</b>

Spare parts

990.014.00	991.060.00
990.014.00	991.060.00
990.014.00	991.060.00

Stop collars with precision clamping nut for quick and easy assembly. The Delrin® protection sleeve lets you work without leaving marks on the workpiece.



# 45° Countersink with Parallel Shank



## 521

**HW Z2 RH LH**

d mm	D mm	D <sub>2</sub> mm	A	S mm		ORDER NO. Right-hand rotation	ORDER NO. Left-hand rotation	Spare parts 
3	12	10	45°	8	10	<b>521.312.11</b>	<b>521.312.12</b>	990.014.00
4	12	10	45°	8	10	<b>521.412.11</b>	<b>521.412.12</b>	990.014.00
5	16	14	45°	10	10	<b>521.516.11</b>	<b>521.516.12</b>	990.014.00
6	16	14	45°	10	10	<b>521.616.11</b>	<b>521.616.12</b>	990.014.00

Spare parts 991.060.00 2mm hex key

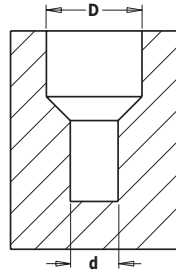

**TECHNICAL DETAILS:**

- Super strength steel.
- 2 HW precision ground cutting edges [Z2].

**APPLICATION:**

for use with spiral bits featuring parallel shank.

# 90° Countersink with Parallel Shank

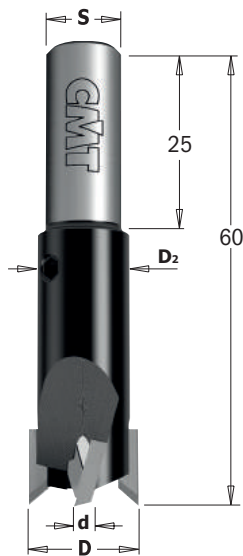

## 515

**HW Z2 V2 RH**

d mm	D mm	D <sub>2</sub> mm	A	S mm		ORDER NO. Right-hand rotation		Spare parts 
4	12	10	90°	10	10	<b>515.412.11</b>		990.014.00
4	14	12	90°	10	10	<b>515.414.11</b>		990.014.00
5	15	14	90°	10	10	<b>515.515.11</b>		990.014.00
6	14	12	90°	10	10	<b>515.614.11</b>		990.014.00
6	15	14	90°	10	10	<b>515.615.11</b>		990.014.00

Spare parts 991.060.00 2mm hex key

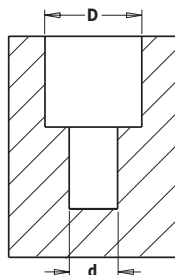

**TECHNICAL DETAILS:**

- Super strength steel.
- 2 HW precision ground cutting edges [Z2].
- 2 HW negatively ground spurs [V2].

**APPLICATION:**

for use with spiral bits featuring parallel shank.

# 90° Countersink with Parallel Shank

HWM Z3 RH

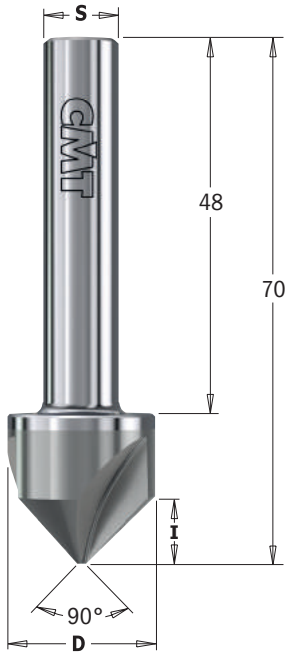

## 521

D mm	I mm	L mm	S mm		ORDER NO.
19,5	9	70	10x48	10	Right-hand rotation <b>521.002.11</b>

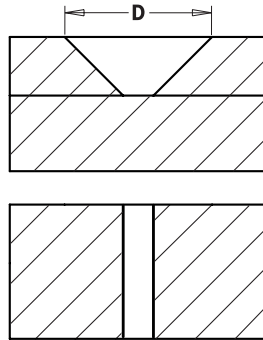

For drilling use bits series **516** or **517**

### TECHNICAL DETAILS:

- For making 90° countersunk blind holes accepting flat-head fasteners that sit flush with the surface.
- 3 wear-resistant precision ground cutting edges providing a smooth finish on hardened materials.
- Solid carbide tool that is harder than cobalt steel, providing a longer tool life at higher speeds.
- Parallel shank to accommodate most drill chucks.
- Suitable for wood, wood-based, non-ferrous materials and metal.

# Drill Bit with Countersink for Screw Joints

SP Z1 RH

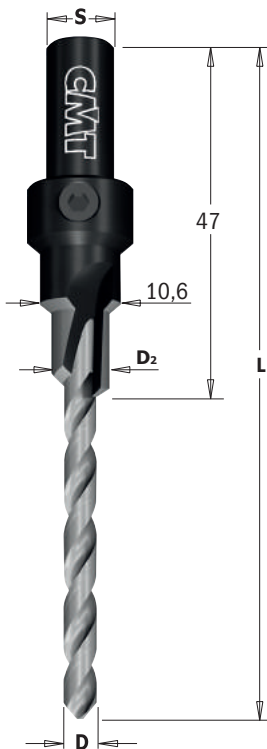

## 515

D mm	D <sub>2</sub> mm	L mm	S mm		ORDER NO.
4,2	7,6	87	9	1	Right-hand rotation <b>515.042.31</b>
5	7,6	93,7	9	1	<b>515.050.31</b>

### TECHNICAL DETAILS:

- Super strength steel.
- SP steel.
- 1 SP precision ground cutting edge [Z1].
- 1 spiral flute.

### APPLICATION:

used for drilling blind holes in soft and hardwood.

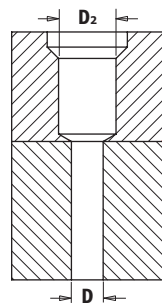

# FASTX4 SYSTEM: THE HOLE SAW REVOLUTION!

CMT's innovative system offers great advantages to all professionals!

## X1 FAST LOCK

### ALL IN ONE CLICK!

We developed a unique patented Fast Lock System to quickly change between sizes and types in seconds!

It is the only system that allows the hole saw and the pilot drill to be changed without tools.



## X2 FAST DRILL

### FAST DRILLING IN ALL CONDITIONS!

Our hole saws have unique body geometry and teeth sharpening which provides fast, precise drilling at Xtreme angles.

- pre-drill at the desired angle
- push the hole saw forward back in position and complete the hole.



## X3 FAST BORE ENLARGEMENT

### UNIQUE SOLUTION FOR BORE ENLARGEMENT!

CMT's has a unique and fast solution to enlarge your bores. Our innovative pilot drill bit can fit two hole saws, allowing you to enlarge a hole in seconds.



## X4 FAST PLUG REMOVAL

### EASY PLUG REMOVAL IN ONE CLICK!

No more screwdrivers or tools!

The plug is effortlessly removed by reversing the pilot drill bit.

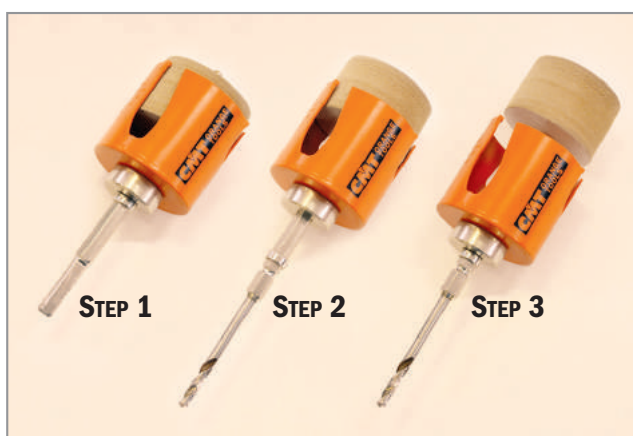

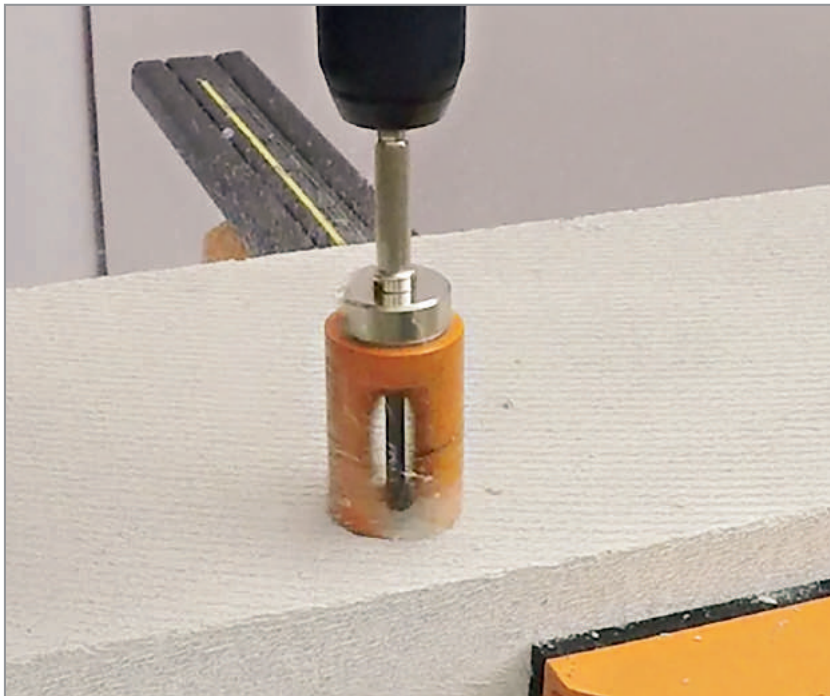

# HOLE SAWS

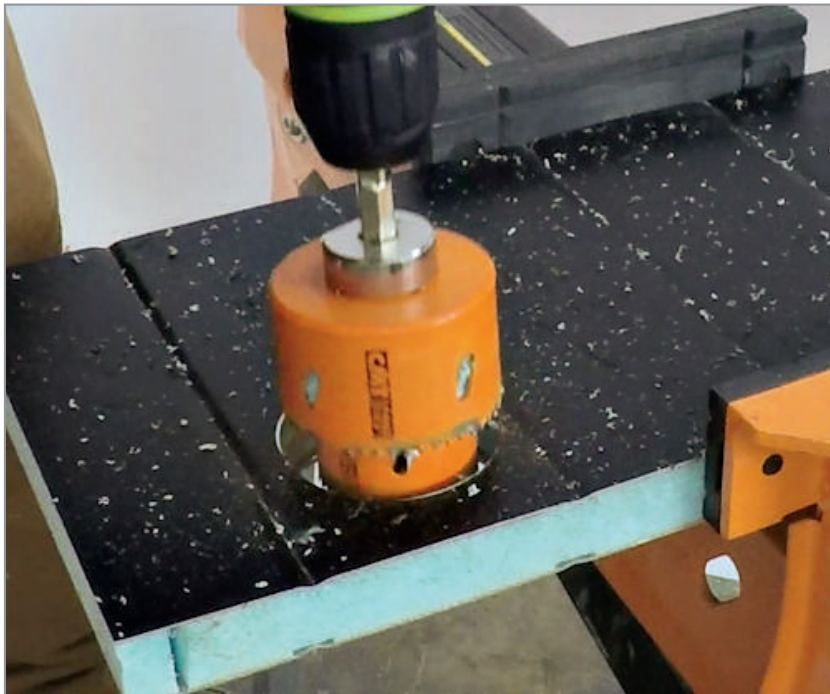

<u>PRODUCTS</u>	<u>PAGE</u>
Tungsten Carbide-Tipped	<b>340-341</b>
Tungsten Carbide-Tipped Long	<b>342-343</b>
Tungsten Carbide-Tipped with Countersink	<b>343</b>
Bi-Metal Plus 8% Cobalt	<b>344-345</b>
Diamond Dry	<b>346-348</b>
Hole Saw Sets	<b>349</b>

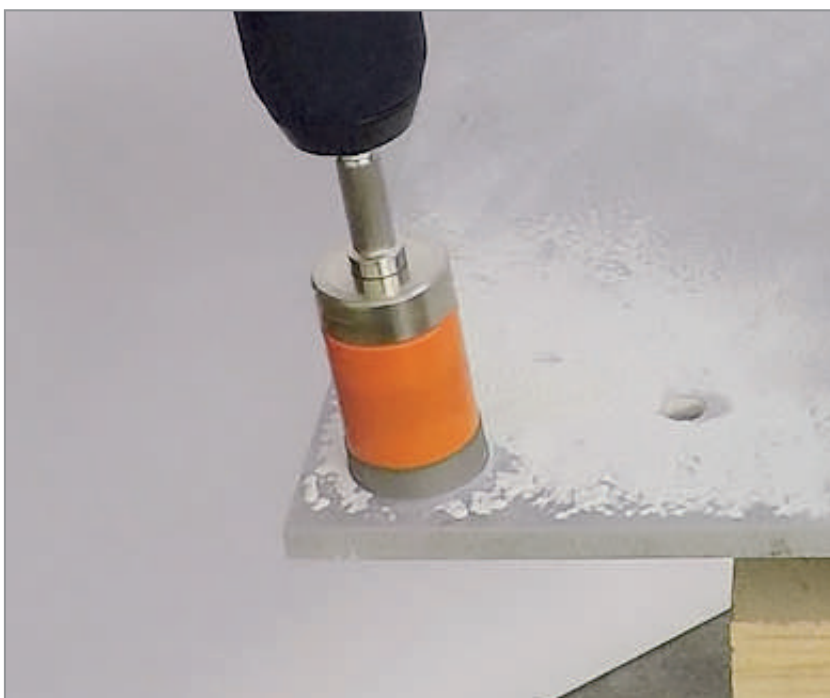

Join us on our  
**You Tube**





# FASTX4 SYSTEM: THE HOLE SAW REVOLUTION!

The innovative patented FASTX4 system makes the hole saw arbor obsolete. These hole saws have been specifically designed to ensure maximum productivity, lifetime and performance in all materials. CMT offers a professional range for electricians, carpenters, builders, kitchen fitters and all related heating, ventilation and plumbing trades.

## SERIES 550 TUNGSTEN CARBIDE-TIPPED SERIES 553 TUNGSTEN CARBIDE-TIPPED LONG



**5X  
FASTER**

**10X  
LONGER LIFE**



**LONG LASTING CONSTRUCTION GRADE CARBIDE.**  
A special formulated construction grade carbide is used for the cutting teeth, which provides 10 times longer cutting life.

Tungsten carbide-tipped multi-purpose hole saws are designed for use in a wide variety of materials such as soft and hardwoods, chipboard, plywood, MDF, plastic, gypsum/plasterboard, soft tiles (surface hardness  $\leq 6$  Mohs), solid brick, brick with cavities, aerated concrete block, lightweight aggregate block, breeze block and soft density lime-sandstone building block (max 30 N/mm<sup>2</sup> hardness).

## SERIES 551 BI-METAL PLUS 8% COBALT



**2X  
LONGER LIFE**

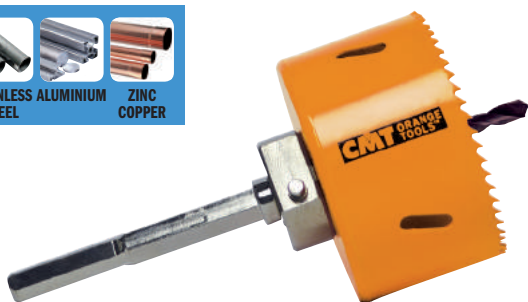

**BI-METAL PLUS 8% COBALT**  
Premium bi-metal with 8% cobalt provides Xtreme results in performance and up to 50% longer lifetime than the competition.

Special tooth geometry with regular pitch provides a smoother cut and better chip clearance preventing clogging and heat build-up. Teeth are alternate & side set to minimize binding and friction requiring less feed pressure. Ideal for mild steel (up to 1000 N/mm<sup>2</sup> strength), stainless steel, non-ferrous metal, aluminium, cast iron, copper and galvanized sheet metal.

## SERIES 552 DIAMOND DRY



**10X  
LONGER LIFE**



**DIAMOND GRIT PREMIUM GRADE**  
Very well-shaped and extremely strong cubo-octahedral inclusion-free heat-resistant crystals to deliver fast clean cuts up to 10 times longer life.

Diamond dry hole saw with continuous edge have been specially developed for professionals that need to drill in extremely hard materials such as tiles (ceramic, gres, etc.), hard stone (granite, marble, etc.), artificial stone (Okite®, Silestone®, etc.), where it is increasingly difficult to drill with conventional hole saws. These hole saws guarantee excellent performance and superior lifetime even in the hardest materials.

## EYE-CATCHING PACKAGING



03.01.0297 (empty box)



03.01.0296 (empty box)



Teeth are protected with heat shrink wrap film

MATERIAL		SERIE 550-553 	SERIE 551 	SERIE 552 	TIPS
Soft and hardwood		>500 holes	<30 holes		
Plywood, table top		>500 holes	<30 holes		
MDF, chipboard, veneered		>500 holes	<30 holes		
Laminated, Trespa®, HPL		>500 holes	<10 holes		
Gypsum and plasterboard		>500 holes	<50 holes		
Fibercement boards, Eternit®		>50 holes	<10 holes		
Sandwich materials			50~75 holes		
Plastic		>100 holes	<20 holes		
Fiberglass		50~100 holes			
Acrylic glass		>100 holes			
Roofing and soft tiles		>50 holes			Not suitable for ceramic tiles
Solid bricks, masonry		>50 holes			
Perforated bricks		>50 holes			
Lime bricks		>50 holes			
Porous and lightweight concrete		>500 holes	<20 holes		
Metals and thin sheet metals			10~40 holes		Use coolant oil
Non-ferrous metals			50~75 holes		Use coolant oil
Aluminium			50~75 holes		Use coolant oil
Stainless steel			30~50 holes		Use coolant oil. Low speed.
Cast iron			5~10 holes		Use coolant oil
Copper, galvanized sheet metal, brass			50~75 holes		Use coolant oil
Tiles (porcelain, gres, quarry)				10~50 holes	Reapply lubricating wax on diameters ranging from 8mm to 16mm
Hard stone (granite, marble), Okite				10~50 holes	Reapply lubricating wax on diameters ranging from 8mm to 16mm

The number of holes is approximate. Material type, thickness and speed can affect such performance.

Examples of applications based on diameter and user (may vary from country to country)

Diameter in mm	19	22	25	30	35	40	44	48	51	54	57	60	64	68	70	76	83	86	92	102	105	127	152	User			
Fitted light	•	•	•	•	•	•	•	•	•	•	•	•	•	•	•	•	•	•	•	•	•	•	•	Electrician			
Cable feedthrough box				•	•							•							•						Electrician		
Switch boxes													•													Electrician	
Plug sockets														•													Electrician
Junction boxes															•	•											
Distributor boxes																	•	•						Electrician			
Air conditioning pipes																				•	•				Heating fitter		
Sanitary and heating pipes	•		•	•	•																					Plumber and heating fitter	
Sanitary, drain and water pipes (insulated)						•	•	•																			Plumber and heating fitter

# FASTX4 Multi-Purpose Hole Saws

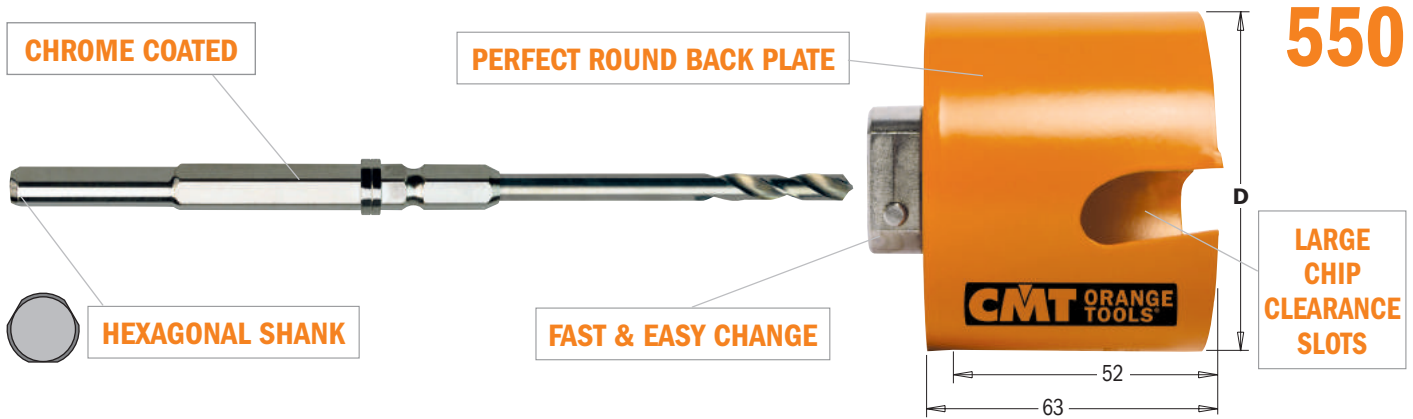

**HW** **LONG LASTING CONSTRUCTION GRADE CARBIDE.**  
Cutting teeth are made of a special formulated construction grade carbide which provides a longer cutting life.



**SECURED TOOTH TECHNOLOGY**  
As a result of the latest technology, teeth are secured to prevent any breakage during impact with hard materials.

**10X** LONGER LIFE  
**5X** FASTER



## MATERIALS

- soft, hardwood and plywood
- chipboard, MDF, veneered, laminated and table top (pre-drill the laminate/melamine by using left-hand rotation for clean finishing)
- gypsum, plasterboard, fibercement board, Eternit®
- plastics (Trespa®, PVC, nylon, polyester)
- fiberglass and acrylic glass
- soft tiles (surface hardness  $\leq 6$  Mohs), solid bricks and bricks with cavities, aerated concrete blocks, lightweight aggregate blocks and breeze blocks, soft density lime-sandstone building blocks (max 30 N/mm<sup>2</sup> hardness); for hardness  $>30$  N/mm<sup>2</sup> use the diamond dry hole saws.

The plug is effortlessly removed thanks to the innovative slots



Soft tiles (surface hardness  $\leq 6$  Mohs)



Wood & MDF



Trespa® & Plastic

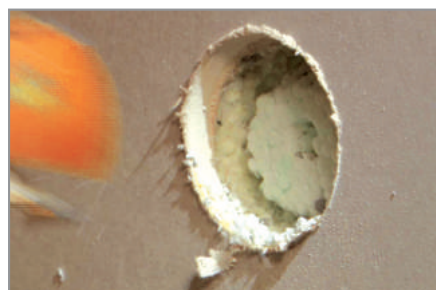

Plasterboard



Soft bricks



Lime bricks



Use the recommended speeds to get optimum lifetime. The speed affects the hole quality.  
Always pre-drill with the center drill to achieve best results.  
The percussion/hammer action mode must be turned off when using these hole saws.





mm	D inches	Z	Wood & MDF RPM	Pvc & FIBERGLASS RPM	MASONRY, BRICK RPM	SOFT TILES RPM	S		ORDER NO.
19	3/4	1	1.600	1.000	1.000	640	Hexagonal	10	550-019
20	13/16	1	1.600	1.000	1.000	640	Hexagonal	10	550-020
22	7/8	1	1.460	1.000	1.000	580	Hexagonal	10	550-022
25	1	1	1.280	1.000	1.000	510	Hexagonal	10	550-025
29	1-1/8	1	1.100	940	940	440	Hexagonal	10	550-029
30	1-3/16	1	1.070	910	910	430	Hexagonal	10	550-030
32	1-1/4	1	1.000	850	850	400	Hexagonal	10	550-032
35	1-3/8	1	920	780	780	370	Hexagonal	10	550-035
38	1-1/2	2	840	720	720	340	Hexagonal	10	550-038
40	1-9/16	2	800	680	680	320	Hexagonal	10	550-040
44	1-3/4	2	730	620	620	290	Hexagonal	10	550-044
<b>new</b> 48	1-7/8	2	680	580	580	270	Hexagonal	10	550-048
51	2	3	630	540	540	250	Hexagonal	10	550-051
52	2-1/16	3	620	530	530	250	Hexagonal	10	550-052
54	2-1/8	3	590	510	510	240	Hexagonal	10	550-054
56	2-3/16	3	570	490	490	230	Hexagonal	10	550-056
57	2-1/4	3	560	480	480	220	Hexagonal	10	550-057
60	2-3/8	3	530	460	460	210	Hexagonal	10	550-060
64	2-1/2	3	500	430	430	200	Hexagonal	10	550-064
65	2-9/16	3	500	430	430	200	Hexagonal	10	550-065
68	2-11/16	3	470	400	400	190	Hexagonal	10	550-068
70	2-3/4	3	460	390	390	180	Hexagonal	10	550-070
73	2-7/8	3	440	370	370	180	Hexagonal	10	550-073
76	3	3	420	360	360	170	Hexagonal	10	550-076
79	3-1/8	3	410	350	350	160	Hexagonal	10	550-079
80	3-5/32	3	400	340	340	160	Hexagonal	10	550-080
82	3-15/64	3	390	330	330	160	Hexagonal	10	550-082
83	3-1/4	3	390	330	330	150	Hexagonal	10	550-083
89	3-1/2	3	360	310	310	140	Hexagonal	10	550-089
92	3-5/8	3	350	300	300	140	Hexagonal	10	550-092
102	4	5	310	270	270	130	Hexagonal	5	550-102
105	4-1/8	5	310	260	260	120	Hexagonal	5	550-105
108	4-1/4	5	300	250	250	120	Hexagonal	5	550-108
111	4-3/8	5	290	250	250	120	Hexagonal	5	550-111
114	4-1/2	5	280	240	240	110	Hexagonal	5	550-114
118	4-5/8	5	280	240	240	110	Hexagonal	2	550-118
127	5	5	250	220	220	100	Hexagonal	2	550-127
133	5-1/4	5	240	210	210	100	Hexagonal	2	550-133
152	6	5	210	180	180	80	Hexagonal	2	550-152
<b>new</b> 160	6-9/32	7	200	150	150	100	Hexagonal	2	550-160
168	6-5/8	7	200	150	150	120	Hexagonal	2	550-168
<b>new</b> 185	7-1/4	7	200	150	150	120	Hexagonal	2	550-185
210	8-1/4	7	200	150	150	120	Hexagonal	1	550-210
225	8-7/8	9	160	120	120	95	Hexagonal	1	550-225
260	10-1/4	9	150	110	110	80	Hexagonal	1	550-260
270	10-5/8	9	140	100	100	70	Hexagonal	1	550-270

**550-HS1** For **Ø20-30mm (25/32" - 1-3/16")**. Hexagonal shank for **10mm (25/64")** chuck, HSS center drill, total length 180mm (7-5/64").



**550-HW1** For **Ø20-30mm (25/32" - 1-3/16")**. Hexagonal shank for **10mm (25/64")** chuck, HW center drill, total length 180mm (7-5/64").



**550-HS2** For **Ø32mm (1-1/4") and above**. Hexagonal shank for **13mm (1/2")** chuck, HSS center drill, total length 180mm (7-5/64").



**550-HW2** For **Ø32mm (1-1/4") and above**. Hexagonal shank for **13mm (1/2")** chuck, HW center drill, total length 180mm (7-5/64").



**550-DB1** Adapter for easy bore enlargement and plug removal. For use with hole saws having different hexagonal shank sizes. Hexagonal shank **13mm (1/2")**.



\* Bore enlargement: feasible with hole saws with 9mm minimum difference between largest and smallest diameter.





# FASTX4 Multi-Purpose Long Hole Saws



# 553

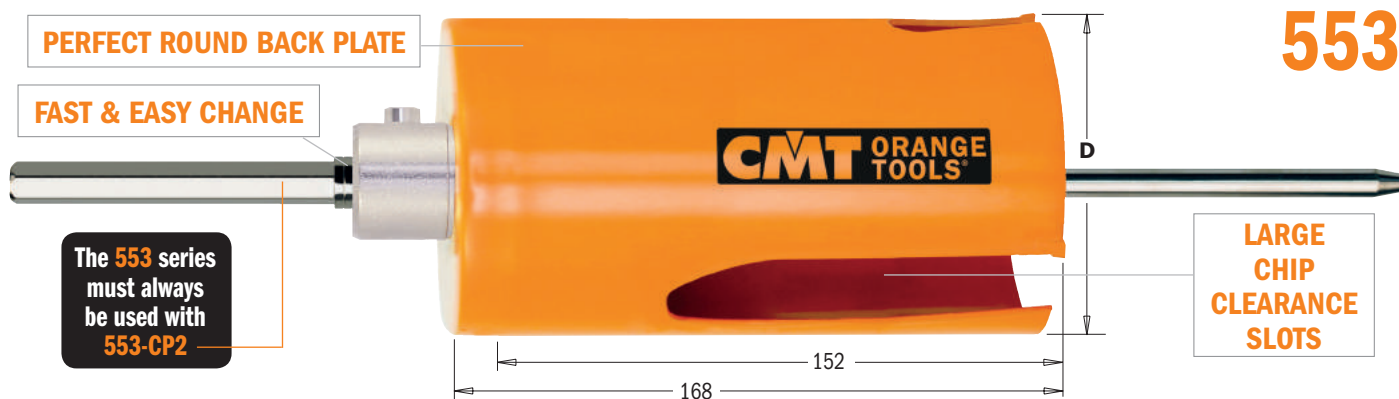

**LONG LASTING CONSTRUCTION GRADE CARBIDE.**  
Cutting teeth are made of a special formulated construction grade carbide which provides a longer cutting life.



**SECURED TOOTH TECHNOLOGY**  
As a result of the latest technology, teeth are secured to prevent any breakage during impact with hard materials.



**553-CP2** Heavy Duty center pin  $\varnothing 10\text{mm}$  (25/64").  
Hexagonal shank, total length 330mm (13").



mm	D inches	Z	Wood & MDF RPM	Pvc & FIBERGLASS RPM	MASONRY, BRICK RPM	TILES RPM	S		ORDER NO.
32	1-1/4	1	800	600	600	400	Hexagonal	10	<b>553-032</b>
45	1-3/4	2	600	450	450	350	Hexagonal	10	<b>553-045</b>
51	2	2	600	450	450	350	Hexagonal	10	<b>553-051</b>
60	2-3/8	2	500	350	350	300	Hexagonal	10	<b>553-060</b>
65	2-9/16	3	500	350	350	300	Hexagonal	10	<b>553-065</b>
68	2-11/16	3	500	350	350	300	Hexagonal	10	<b>553-068</b>
70	2-3/4	3	500	350	350	300	Hexagonal	10	<b>553-070</b>
76	3	3	500	350	350	300	Hexagonal	10	<b>553-076</b>
80	3-5/32	3	300	250	250	200	Hexagonal	10	<b>553-080</b>
83	3-1/4	3	300	250	250	200	Hexagonal	10	<b>553-083</b>
86	3-3/8	3	300	250	250	200	Hexagonal	10	<b>553-086</b>
92	3-5/8	3	300	250	250	200	Hexagonal	10	<b>553-092</b>
102	4	4	300	250	250	200	Hexagonal	5	<b>553-102</b>
105	4-1/8	4	300	250	250	200	Hexagonal	5	<b>553-105</b>
111	4-3/8	4	200	150	150	120	Hexagonal	5	<b>553-111</b>
114	4-1/2	4	200	150	150	120	Hexagonal	5	<b>553-114</b>
121	4-3/4	4	200	150	150	120	Hexagonal	5	<b>553-121</b>
127	5	5	200	150	150	120	Hexagonal	5	<b>553-127</b>
130	5-1/8	5	200	150	150	120	Hexagonal	5	<b>553-130</b>
133	5-1/4	5	200	150	150	120	Hexagonal	5	<b>553-133</b>
140	5-1/2	5	200	150	150	120	Hexagonal	1	<b>553-140</b>
152	6	5	200	150	150	120	Hexagonal	1	<b>553-152</b>
160	6-5/16	6	200	150	150	120	Hexagonal	1	<b>553-160</b>
177	7	6	200	150	150	120	Hexagonal	1	<b>553-177</b>
190	7-1/2	6	200	150	150	120	Hexagonal	1	<b>553-190</b>
210	8-1/4	7	200	150	150	120	Hexagonal	1	<b>553-210</b>

**542.100.51** Auger bit  $\varnothing 10\text{mm}$  (25/64") to pre-drill deep holes in wood and wood-based.  
Hexagonal shank, total length 200mm (7-7/8").



**553-HW10** Carbide tipped bit  $\varnothing 10\text{mm}$  (25/64") to pre-drill deep holes in masonry materials.  
Hexagonal shank, total length 200mm (7-7/8").



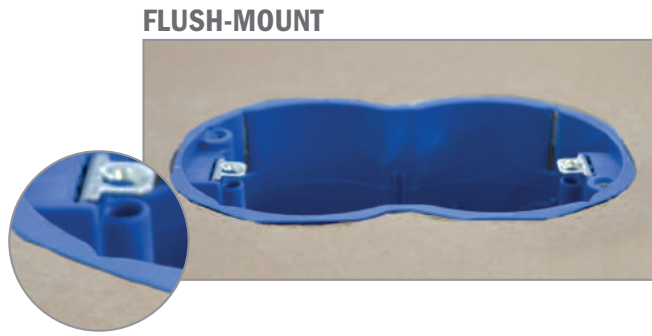
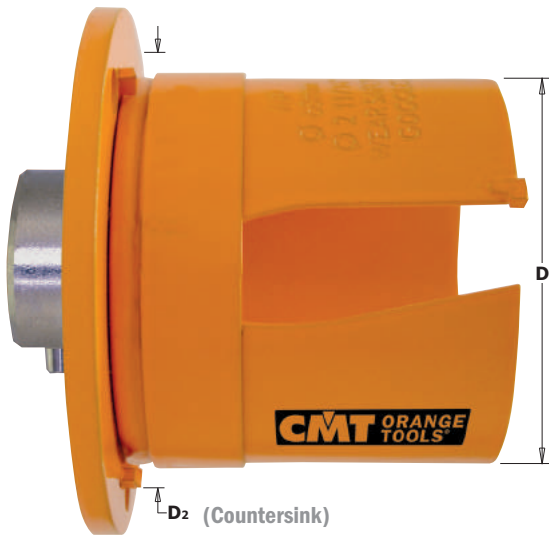

**NO FLUSH-MOUNT**

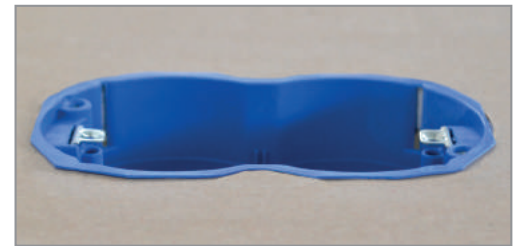

**APPLICATIONS**

in plasterboard, gypsum, wood, plywood, chipboard, MDF, fiber cement boards, plastics, bricks and tiles **for electric flush-mount case installation.**



Example of commercial electric flush-mount boxes.

D		D <sub>2</sub>		Z	WOOD & MDF	PVC & FIBERGLASS	MASONRY, BRICK	TILES	S		ORDER NO.
mm	inches	mm	inches		RPM	RPM	RPM	RPM			
68	2-11/16	74	2-15/16	3+3	470	400	400	190	Hexagonal	10	<b>550-068CS</b>

**Hole Saws Accessories**

**550-HS2XL** For  $\varnothing 32\text{mm}$  (1-1/4") and above. **Long heavy duty**, hexagonal shank for 13mm (1/2") chucks, HSS center drill, total length 320mm (12-19/32").



**550-HW2XL** For  $\varnothing 32\text{mm}$  (1-1/4") and above. **Long heavy duty**, hexagonal shank for 13mm (1/2") chucks, HW center drill, total length 320mm (12-19/32").



**551-HS2XL** For  $\varnothing 32\text{mm}$  (1-1/4") and above. **Long heavy duty**, hexagonal shank for 13mm (1/2") chucks, HSS center drill, total length 320mm (12-19/32").



**550-EX1 / 550-EX2** Extension for Pilot Bits. **Long heavy duty**, hexagonal shank for 13mm (1/2") chucks. Not compatible with **XL** accessories.



S	L	FOR CHUCK		ORDER NO.
	mm	inches	mm	
Hexagonal	300	11-13/16	10	<b>550-EX1</b>
Hexagonal	300	11-13/16	13	<b>550-EX2</b>

**550-SDS1 / 550-SDS2** SDS Adapter for Pilot Bits. SDS shank. Not compatible with **XL** and **EX** accessories.

S	L	FOR CHUCK		ORDER NO.
	mm	inches	mm	
SDS	95	3-3/4	10	<b>550-SDS1</b>
SDS	95	3-3/4	13	<b>550-SDS2</b>



# FASTX4 Bi-Metal Plus Hole Saws

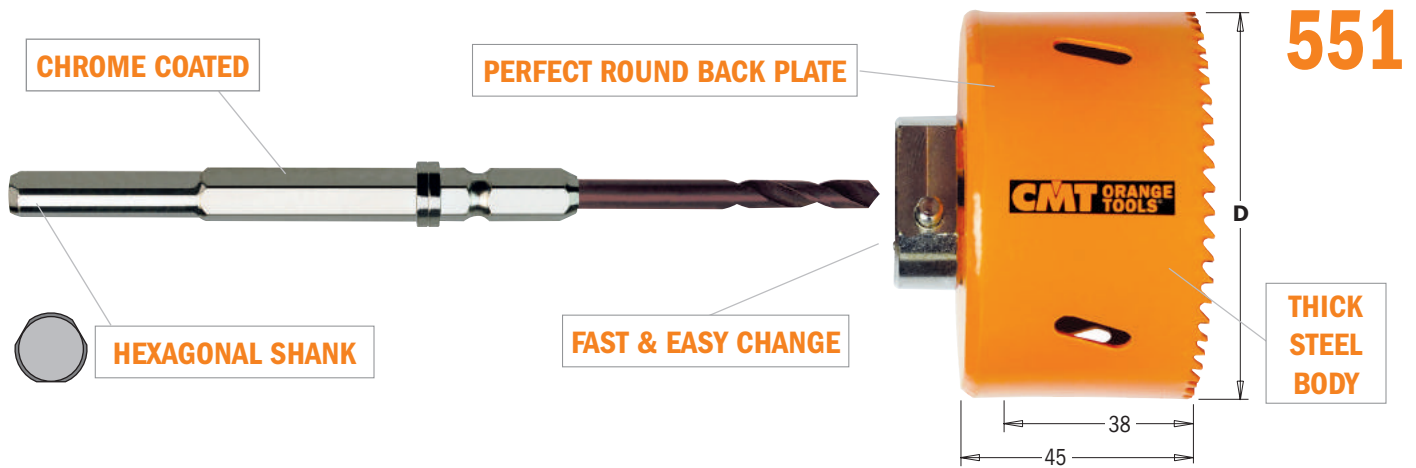

## MATERIALS

- metals (up to 1000 N/mm<sup>2</sup> strength)
- mild steel,
- stainless steel
- non-ferrous metals, aluminium
- sandwich materials
- cast iron
- copper, galvanized sheet metal, brass



## BI-METAL PLUS 8% COBALT

Premium bi-metal with 8% cobalt provides Xtreme results in performance and up to 50% longer lifetime than the competition.



## ALTERNATE & SIDE SET TEETH



## TEETH DESIGN

Special tooth geometry with regular pitch provides a smoother cut and better chip clearance preventing clogging and heat build-up. Teeth are alternate & side set to minimize binding and friction, requiring less feed pressure.

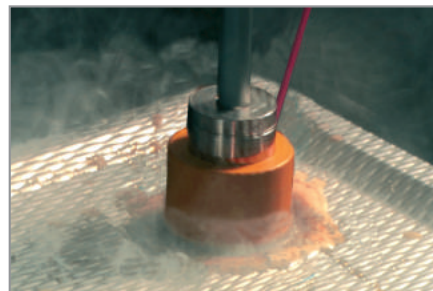

Stainless steel and cast iron



Galvanized sheet metal, aluminium and copper



## SPEED KILLS!

Operating at higher speeds than those recommended will shorten hole saw life and produce very inefficient cutting.



## FEED PRESSURE:

Variables in material, work configuration should be considered. Apply sufficient feed pressure to aid good chip removal. Reduce the pressure when hole saw becomes hot or if teeth start to clog with material. Insufficient feed pressure will dull tooth points prematurely, but too much pressure can totally destroy teeth.



## COOLING LUBRICANT:

Cutting oil serves several purposes when sawing in metals:

- it cools saw and workpiece
- it reduces heat and abrasion, which can shorten cutting life
- it also helps remove swarf from the cutting surface
- using a cooling lubricant will extend your hole saw life by 500%.



Percussion/hammer action mode must be turned off when using these hole saws.





mm	D inches	METAL RPM	STAINLESS STEEL RPM	CAST IRON RPM	ALUMINIUM RPM	S		ORDER NO.
16	5/8	550	270	370	800	Hexagonal	10	551-016
19	3/4	470	230	310	670	Hexagonal	10	551-019
20	13/16	440	220	290	640	Hexagonal	10	551-020
22	7/8	400	200	270	580	Hexagonal	10	551-022
25	1	350	170	230	510	Hexagonal	10	551-025
27	1-1/16	330	160	220	470	Hexagonal	10	551-027
29	1-1/8	310	150	200	440	Hexagonal	10	551-029
30	1-3/16	300	140	190	430	Hexagonal	10	551-030
32	1-1/4	280	140	180	400	Hexagonal	10	551-032
35	1-3/8	250	120	170	370	Hexagonal	10	551-035
38	1-1/2	230	110	150	340	Hexagonal	10	551-038
40	1-9/16	220	110	150	320	Hexagonal	10	551-040
43	1-11/16	210	100	140	300	Hexagonal	10	551-043
44	1-3/4	200	100	130	290	Hexagonal	10	551-044
48	1-7/8	180	90	120	270	Hexagonal	10	551-048
51	2	170	85	110	250	Hexagonal	10	551-051
52	2-1/16	160	80	110	240	Hexagonal	10	551-052
54	2-1/8	160	80	110	240	Hexagonal	10	551-054
57	2-1/4	160	75	100	220	Hexagonal	10	551-057
60	2-3/8	150	70	95	210	Hexagonal	10	551-060
64	2-1/2	140	70	90	205	Hexagonal	10	551-064
65	2-9/16	140	70	90	205	Hexagonal	10	551-065
68	2-11/16	130	65	80	185	Hexagonal	10	551-068
70	2-3/4	130	60	80	185	Hexagonal	10	551-070
73	2-7/8	120	60	80	180	Hexagonal	10	551-073
76	3	120	55	75	170	Hexagonal	10	551-076
79	3-1/8	110	55	70	165	Hexagonal	10	551-079
83	3-1/4	105	50	70	155	Hexagonal	10	551-083
86	3-3/8	105	50	65	150	Hexagonal	10	551-086
89	3-1/2	100	50	65	145	Hexagonal	10	551-089
92	3-5/8	95	45	60	140	Hexagonal	10	551-092
102	4	85	45	55	130	Hexagonal	5	551-102
105	4-1/8	80	40	55	120	Hexagonal	5	551-105
108	4-1/4	80	40	55	120	Hexagonal	5	551-108
114	4-1/2	80	40	55	120	Hexagonal	5	551-114
127	5	70	35	45	90	Hexagonal	2	551-127
133	5-1/4	65	35	45	90	Hexagonal	2	551-133
140	5-1/2	65	30	40	85	Hexagonal	2	551-140
152	6	55	25	35	75	Hexagonal	2	551-152
168	6-5/8	55	25	35	75	Hexagonal	2	551-168

Cooling



CUTTING OIL

CUTTING OIL

DRY

TURPENTINE



**551-HS1**

For Bi-Metal PLUS hole saws **Ø16-30mm (5/8" - 1-3/16")**.  
Hexagonal shank for **10mm (25/64")** chuck, HSS center drill, total length 160mm (6-5/16").



**551-HS2**

For Bi-Metal PLUS hole saws **Ø32 (1-1/4") and above**.  
Hexagonal shank for **13mm (1/2")** chuck, HSS center drill, total length 160mm (6-5/16").



**552**

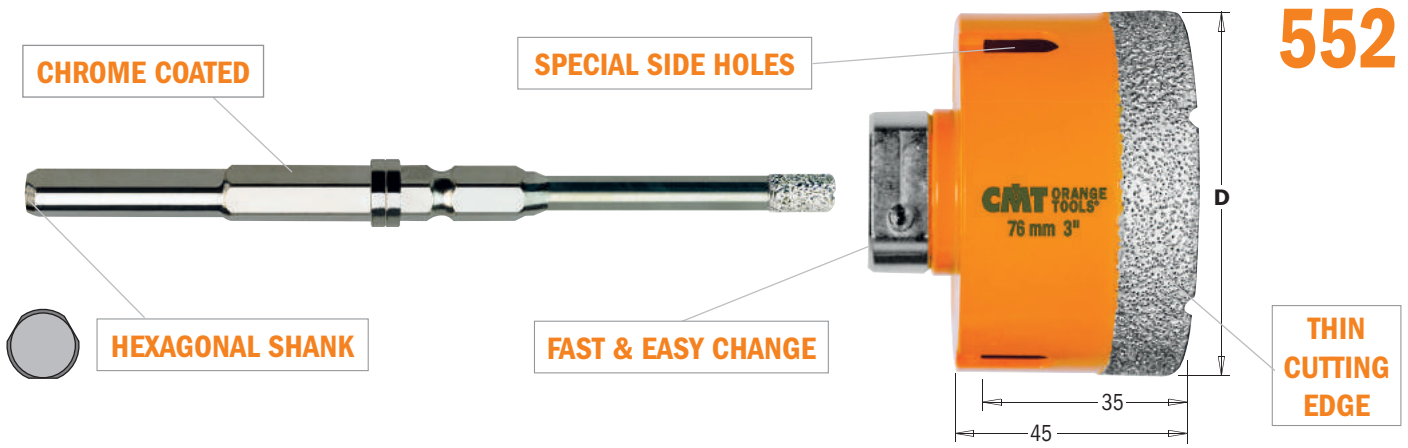

**MATERIALS**

- tiles (ceramic, gres, etc.)
- hard stones (granite, marble, etc.)
- artificial stone (Okite®, Silestone®, etc.)



**DIAMOND GRIT PREMIUM GRADE**

Well-shaped and extremely strong cubo-octahedral inclusion-free heat-resistant crystals deliver fast, clean cuts up to 10 times longer life.



Diamond dry hole saw with continuous edge have been specially developed for professionals that need to drill in extremely hard materials where it is increasingly difficult to drill with conventional hole saws. These hole saws guarantee excellent performance and superior lifetime!



Ceramic and Gres tiles

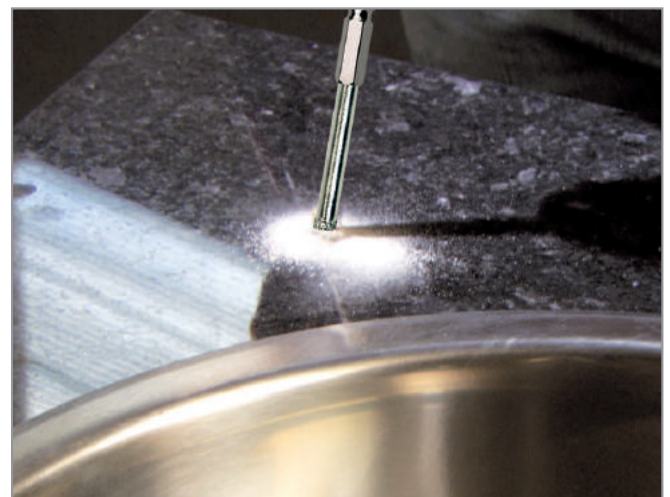

Granite and Marble

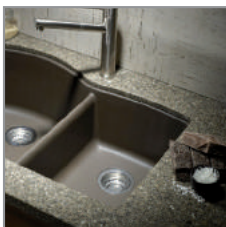

**HARD STONE**

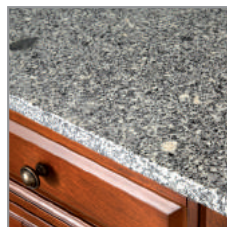

**GRANITE**

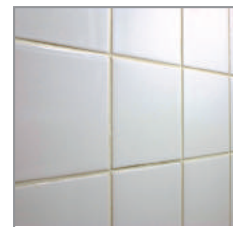

**GRES TILES**



Percussion/hammer action mode must be turned off when using these hole saws.  
 We recommend the use of a high speed drill (minimum 14V recommended).  
 Always pre-drill with the center drill to achieve the best results.  
 Center drill reduces the risk of slipping of hole saw.





D		TILES (CERAMIC & GRES) HARD STONE, ARTIFICIAL STONE	S		ORDER NO.
mm	inches				
18	45/64	RPM 1500 ~ 4000	Hexagonal	10	<b>552-018</b>
20	13/16	RPM 1500 ~ 4000	Hexagonal	10	<b>552-020</b>
25	1	RPM 1500 ~ 4000	Hexagonal	10	<b>552-025</b>
32	1-1/4	RPM 1500 ~ 4000	Hexagonal	10	<b>552-032</b>
35	1-3/8	RPM 1500 ~ 4000	Hexagonal	10	<b>552-035</b>
38	1-1/2	RPM 1500 ~ 4000	Hexagonal	10	<b>552-038</b>
51	2	RPM 1500 ~ 4000	Hexagonal	10	<b>552-051</b>
55	2-3/16	RPM 1500 ~ 4000	Hexagonal	10	<b>552-055</b>
68	2-11/16	RPM 1500 ~ 4000	Hexagonal	10	<b>552-068</b>
73	2-7/8	RPM 1500 ~ 4000	Hexagonal	10	<b>552-073</b>
76	3	RPM 1500 ~ 4000	Hexagonal	10	<b>552-076</b>
111	4-3/8	RPM 1500 ~ 4000	Hexagonal	5	<b>552-111</b>



**552-DD1** For diamond dry hole saws  $\leq \varnothing 30\text{mm}$  (1-3/16").  
Hexagonal shank for **10mm** (25/64") chuck, 8mm diamond center drill, total length 143mm (5-5/8").



**552-DD2** For diamond dry hole saws  $\geq \varnothing 32\text{mm}$  (1-1/4").  
Hexagonal shank for **13mm** (1/2") chuck, 10mm diamond center drill, total length 143mm (5-5/8").



**552-WAX**  
Jar **20ml. (0.68oz)**. Cooling Wax, for perfect cooling and lubrication.

**NO WATER, LESS MESS!**

## Diamond dry step-by-step





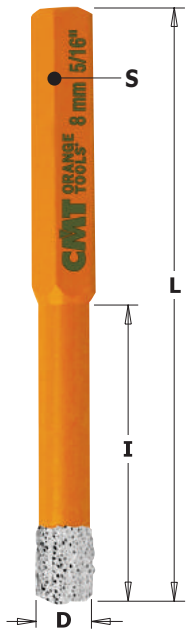

RPM 1500 ~ 4000



Filled with cooling wax

**552-0**

D		I	L	TILES (CERAMIC & GRES) HARD STONE, ARTIFICIAL STONE	S		ORDER NO.
mm	inches	mm	mm				
5	13/64	30	68	RPM 1500 ~ 4000	Hexagonal	10	<b>552-005</b>
6	1/4	30	68	RPM 1500 ~ 4000	Hexagonal	10	<b>552-006</b>
8	5/16	40	80	RPM 1500 ~ 4000	Hexagonal	10	<b>552-008</b>
10	3/8	40	80	RPM 1500 ~ 4000	Hexagonal	10	<b>552-010</b>
12	15/32	40	80	RPM 1500 ~ 4000	Hexagonal	10	<b>552-012</b>
14	9/16	40	80	RPM 1500 ~ 4000	Hexagonal	10	<b>552-014</b>
16	5/8	40	80	RPM 1500 ~ 4000	Hexagonal	10	<b>552-016</b>



**552-001-05**  
5 PIECE HOLE SAW SET

- 552-005
- 552-006
- 552-008
- 552-010
- 552-012



Filled with cooling wax

**552-5**

D		I	L	TILES (CERAMIC & GRES) HARD STONE, ARTIFICIAL STONE	S		ORDER NO.
mm	inches	mm	mm				
6	1/4	35	60	MAX RPM 14000	M14	10	<b>552-506</b>
8	5/16	35	60	MAX RPM 14000	M14	10	<b>552-508</b>
10	3/8	35	60	MAX RPM 14000	M14	10	<b>552-510</b>
12	1/2	35	60	MAX RPM 14000	M14	10	<b>552-512</b>
20	13/16	35	60	MAX RPM 14000	M14	5	<b>552-520</b>
25	1	40	60	MAX RPM 14000	M14	5	<b>552-525</b>
28	1-1/8	40	60	MAX RPM 14000	M14	5	<b>552-528</b>
35	1-3/8	40	60	MAX RPM 14000	M14	5	<b>552-535</b>
43	1-3/4	40	60	MAX RPM 14000	M14	5	<b>552-543</b>
68	2-11/16	40	60	MAX RPM 14000	M14	5	<b>552-568</b>



**552-501-06**  
6 PIECE HOLE SAW SET

- 552-506
- 552-008
- 552-010
- 552-012
- 552-GUIDE
- 552-EX14



**552-EX14**  
Hexagonal adapter for electric drills (M14)  
Pack Qty. 10 pc.



**552-GUIDE**  
Vacuum Drill Guide with 7 holes

B		B		ORDER NO.
mm		inches		
4-5-6-7-8-10-12		5/32-3/16-1/4-9/32-5/16-3/8-1/2	10	<b>552-GUIDE</b>

# BUY HOLE SAWS + ARBORS AND YOU'LL GET THE CASE TO COLLECT THE WHOLE SET FOR FREE!



**03.01.0297**

The big case is provided empty, image is purely indicative.



**03.01.0296**

The small case is provided empty, image is purely indicative.



## SERIES 550 TUNGSTEN CARBIDE-TIPPED

ORDER NO.	Ø	ORDER NO.	Ø	ORDER NO.
550-020	20	550-056	56	550-HS2
550-022	22	550-060	60	550-HW2
550-025	25	550-064	64	550-HS1
550-029	29	550-068	68	550-HW1
550-030	30	550-070	70	
550-032	32	550-073	73	
550-035	35	550-076	76	
550-040	40	550-080	80	
550-044	44	550-102	102	
550-051	51	550-152	152	

**20+4**  
pcs.



## SERIES 550 TUNGSTEN CARBIDE-TIPPED

ORDER NO.	Ø	ORDER NO.	Ø	ORDER NO.
550-025	25	550-060	60	550-HS2
550-032	32	550-064	64	550-HW2
550-035	35	550-068	68	550-HS1
550-040	40	550-080	80	550-HW1
550-051	51	550-102	102	

**10+4**  
pcs.



## SERIES 551 BI-METAL PLUS 8% COBALT

ORDER NO.	Ø	ORDER NO.	Ø	ORDER NO.
551-020	20	551-040	40	551-HS2
551-022	22	551-043	43	551-HS1
551-025	25	551-051	51	
551-030	30	551-060	60	
551-035	35	551-079	79	

**10+2**  
pcs.



## SERIES 551 BI-METAL PLUS 8% COBALT

ORDER NO.	Ø	ORDER NO.	Ø	ORDER NO.
551-020	20	551-057	57	551-HS2
551-022	22	551-060	60	551-HS1
551-025	25	551-064	64	
551-027	27	551-068	68	
551-030	30	551-076	76	
551-035	35	551-079	79	
551-040	40	551-083	83	
551-043	43	551-089	89	
551-048	48	551-102	102	
551-051	51	551-108	108	

**20+2**  
pcs.



## SERIES 552 DIAMOND DRY

ORDER NO.	Ø	ORDER NO.	Ø	ORDER NO.
552-005	5	552-016	16	552-DD2
552-006	6	552-020	20	552-DD1
552-008	8	552-025	25	552-WAX
552-010	10	552-032	32	
552-012	12	552-035	35	

**10+3**  
pcs.





# POWER TOOLS, JIGS & ACCESSORIES

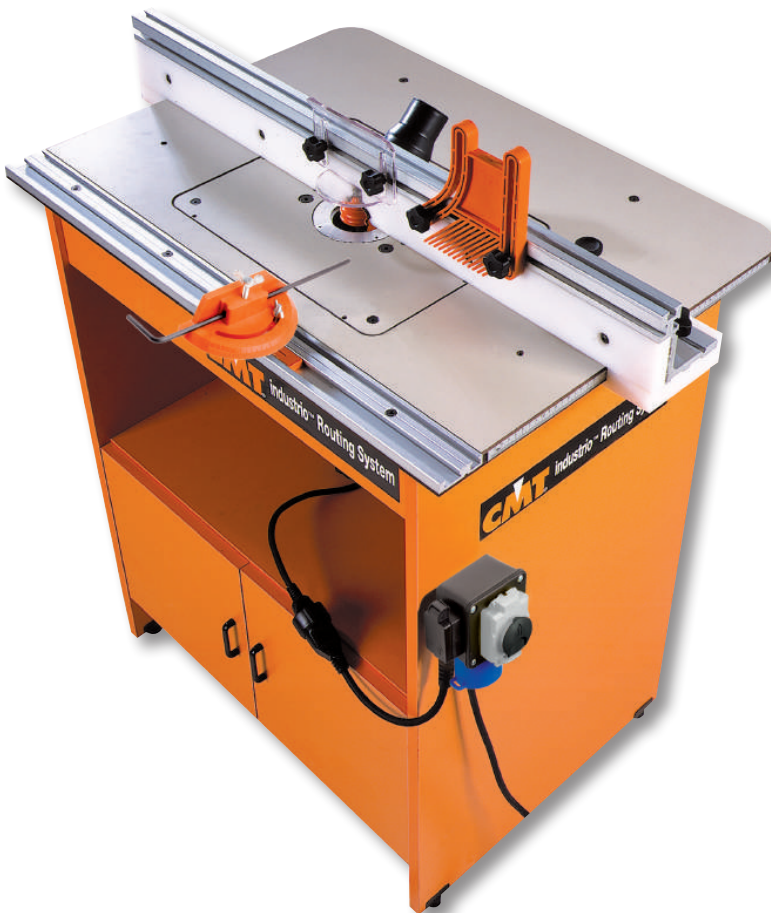

PRODUCTS	PAGE
Routers & Trimmer	352~354
Oscillating Multi-Tools	355
Router Tables	356-357
Pocket-Pro™ Joinery System	358
Small Stock Holder	359
Professional Straight Edge Clamps	360
Adjustable Precision Router Dado Jig	361
Universal Dovetail Jig	362-363
Eclipse & Circle Cutting Jig	364
Kitchen Worktop Jig	365
Universal Hinges Boring Systems	366-368
Bench Block Set	368
Inlay & Template Guide Kit	369
Universal Boring Template and Jig	370-371
3D Router Carver System	372~374
Organizer	374
Tools Cleaner & Lubricant	375
Flexible Templates for Routing	376
Edge Banding Jigs	377
Digital Height Gauge	378
Digital Moisture Meter	378
Digital Angle Gauge & Finder	379
Diamond Whetstones	380
Bowl & Tray System	381
Folding Ruler	382
Carpenter Pencil	382
CMT Professional Tool Bag	382

# 1KW Router

## CMT8E

### QUICK ACCESS BRUSHES

change worn brushes quickly and easily.



### SAFETY SWITCH SHUTTER

locks during bit change mode to prevent accidental power on.



### ELECTRONIC SPEED CONTROL & SOFT START

From 8.000 - 20.000 RPM.

### FULLY ENCLOSED GUARDING

provides maximum protection from the cutting zone.

### MULTI-FUNCTION FENCE

provides excellent control for hand-held use and circle cutting.

### QUICK FIT PINS

for fast fitment and removal from its fence.

### SIDE AIR VENTS

reduces intake of dust into the motor casing when mounted upside-down in a router table.

### TOP OF TABLE HEIGHT ADJUSTMENT

Top of table height adjustment is possible using the height winder handle from the template guide kit.

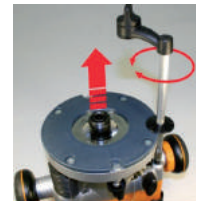

#### Optional

#### Clamping nuts and collets for CMT8E and CMT7E

DIAMETER	ORDER NO.
D = 6mm	796.660.00
D = 6,35mm	796.664.00
D = 8mm	796.680.00
D = 10mm	796.700.00
D = 12mm	796.720.00
D = 12,7mm	796.727.00



#### Optional

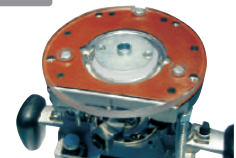

DESCRIPTION	ORDER NO.
Prebored router plate for CMT7E and CMT8E	CMT300-SB
Guide bush Ø30mm	899.007.00

#### STANDARD EQUIPMENT

- Extended baseplate with adjustable fence
- Fine micrometric adjustment knob.
- Dust extraction outlet
- Easy adjustment
- Wrench for easy cutter change

- Ø8 and Ø12mm collets
- 1 year warranty
- Instruction manual

#### Worldwide Technical Assistance

#### TECHNICAL SPECIFICATIONS

- Power..... 1 KW
- Input..... 220/230V (50/60Hz)
- No load speed ..... 8.000-20.000 RPM
- Plunge stroke ..... 0-59mm
- Collet diameter..... Ø6-12,7mm
- Tool weight..... 3,8 Kg

DESCRIPTION	ORDER NO.
Router complete with standard equipment	CMT8E



# 2.4KW Router



## CMT7E

### REMOVABLE PLUNGE SPRING

for easy bit adjustment when table mounted.



### ELECTRONIC SPEED CONTROL & SOFT START

From 8.000 - 20.000 RPM

### SWITCH FROM A PLUNGE TO A FIXED BASE ROUTER

by simply pressing or releasing the button.



### QUICK ACCESS BRUSHES

change worn brushes quickly and easily.



### SAFETY SWITCH SHUTTER

locks during bit change mode to prevent accidental power on.

### FULLY ENCLOSED GUARDING

provides maximum protection from the cutting zone.

### SIDE AIR VENTS

reduces intake of dust into the motor casing when mounted upside-down in a router table.

### MULTI-FUNCTION FENCE

provides excellent control for hand-held use and circle cutting.

### 3 STAGE TURRET

with direct reading scales (mm) for precise preset cut depths.



### TOP OF TABLE HEIGHT ADJUSTMENT

Top of table height adjustment is possible using the height winder handle from the template guide kit.

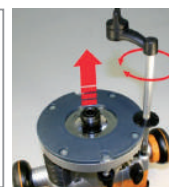

Watch the video on



### STANDARD EQUIPMENT

- Extended baseplate with adjustable fence
- Dust extraction outlet
- Infinite micro adjustment
- Wrench for easy cutter change
- Ø8 and Ø12mm collets
- 1 year warranty
- Instruction manual

### Worldwide Technical Assistance

#### Optional

#### Clamping nuts and collets for CMT8E and CMT7E

DIAMETER	ORDER NO.
D = 6mm	796.660.00
D = 6,35mm	796.664.00
D = 8mm	796.680.00
D = 10mm	796.700.00
D = 12mm	796.720.00
D = 12,7mm	796.727.00



#### Optional



DESCRIPTION	ORDER NO.
Prebored router plate for CMT7E and CMT8E	CMT300-SB
Guide bush Ø30mm	899.007.00



### TECHNICAL SPECIFICATIONS

- Power ..... 2.4 KW
- Input ..... 220/230V (50/60Hz)
- No load speed ..... 8.000-20.000 RPM
- Plunge stroke ..... 0-68mm
- Collet diameter..... Ø6-12,7mm
- Tool weight..... 6,3 Kg

DESCRIPTION	ORDER NO.
Router complete with standard equipment	<b>CMT7E</b>





# 550W Professional Trimmer

**CMT10**

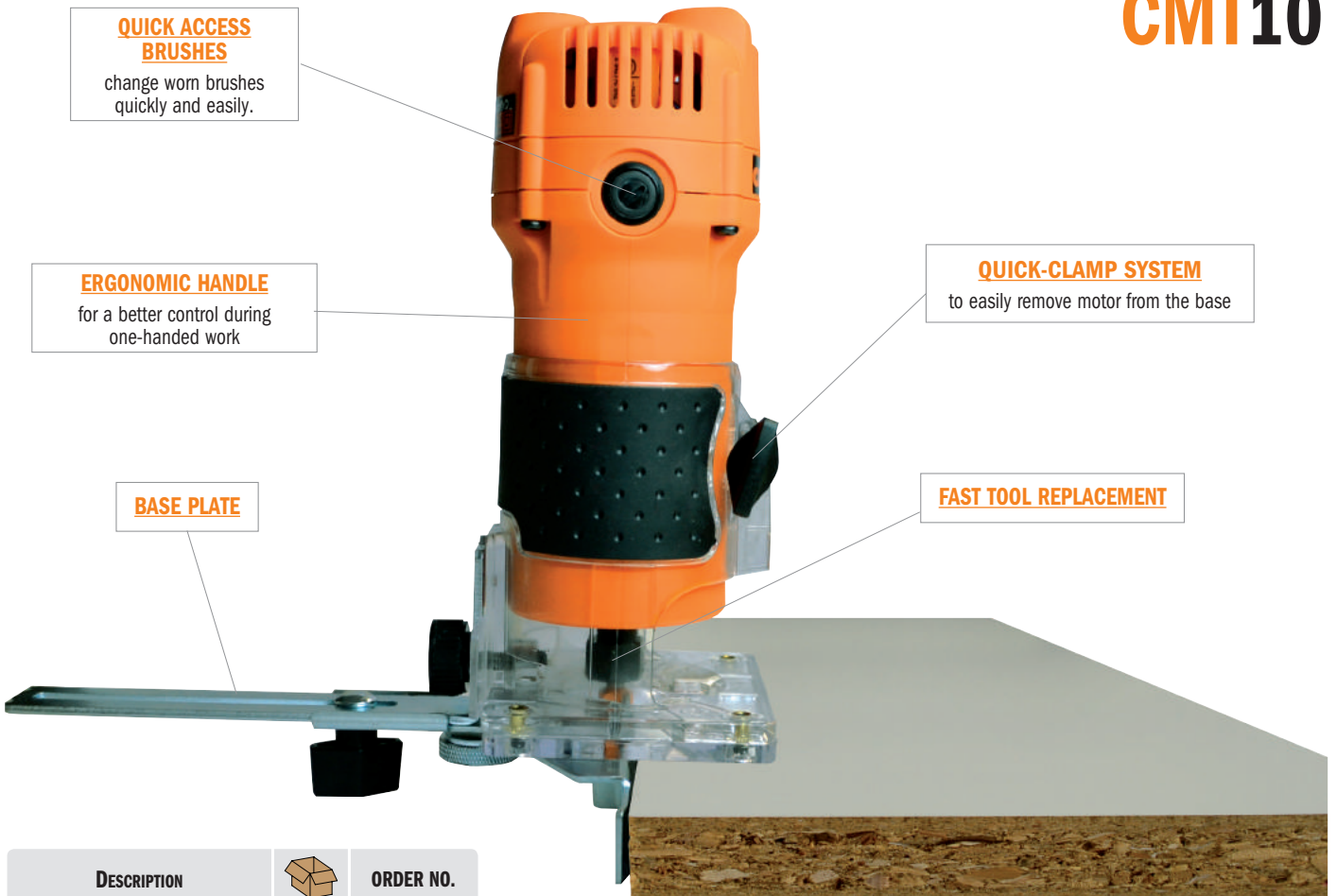

**QUICK ACCESS BRUSHES**  
change worn brushes quickly and easily.

**ERGONOMIC HANDLE**  
for a better control during one-handed work

**QUICK-CLAMP SYSTEM**  
to easily remove motor from the base

**FAST TOOL REPLACEMENT**

**BASE PLATE**

DESCRIPTION		ORDER NO.
550W Professional Trimmer	8	<b>CMT10</b>

### Standard Equipment

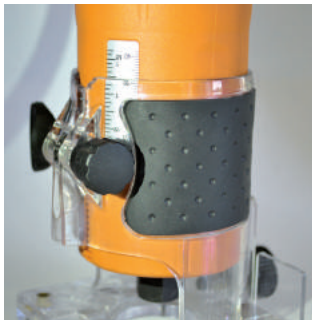

Aluminium-embossed scale for accurate setting of the desired routing depth

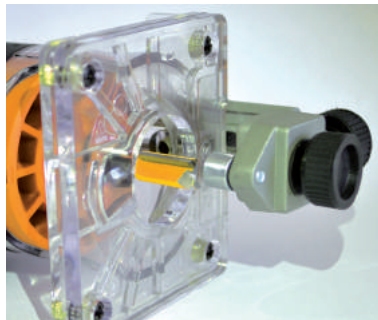

Trimmer guide with Delrin® roller prevents marks on the workpiece

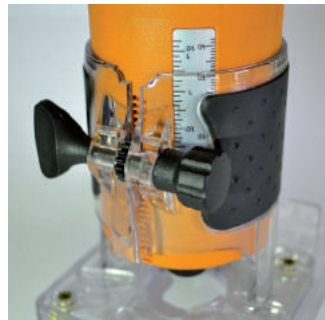

Fine depth adjustment



**CMT10-54**  
Ø10mm guide bush

### Standard Equipment

- Extended baseplate with adjustable fence
- Trimmer guide
- Guide bush
- 2 wrenches for easy cutter replacement (12 and 17mm)
- Ø6mm and Ø8mm collet
- 1 year warranty
- Instruction manual

### Worldwide Technical Assistance

#### TECHNICAL SPECIFICATIONS:

- Power ..... 550 Watt
- Input ..... 220/230V (50/60Hz)
- No load speed ..... 32.000 RPM
- Plunge stroke ..... 0-24mm
- Collet diameter ..... Ø6-8mm
- Tool weight ..... 1,6 Kg

### Spare parts



**CMT10-16A**  
Dust guard & base plate



**CMT10-17**  
Clamping nut



**CMT10-18** Collet Ø6mm  
**CMT10-18A** Collet Ø6,35mm  
**CMT10-18B** Collet Ø8mm



**CMT10-30**  
Pair of carbon brushes

**CMT11**

**FAST LOCK**



**SPEED CONTROL 1-6**

**MULTI MATERIALS & APPLICATIONS:**



- GRINDING
- SAWING
- JOINT OPENING
- PLASTIC CUTTING
- CARPET REMOVAL
- PLUNGE CUTTING
- WOOD CUTTING
- CUTTING LAMINATE SHEETS
- TUBE LENGTH TRIMMING
- NAIL CUTTING



**FAST LOCK**



**INCLUDED:**



**HANDLE**



**VACUUM HOSE**

**Standard Equipment**

- 1 x Oscillating Multi-tool
- 1 x handle
- 1 x vacuum hose
- 1 x manual
- 1 x plastic carry case

**TECHNICAL SPECIFICATIONS:**

- Power.....300 Watt
- Input.....220/230V (50/60Hz)
- No load speed .....11.000~21.000 RPM
- aw (vibration).....19,7m/s<sup>2</sup> - K=1,5m/s<sup>2</sup>
- Tool weight.....1,5 Kg

DESCRIPTION		ORDER NO.
300W Oscillating Multi-Tools	5	CMT11

**Worldwide Technical Assistance**





# New Professional Router Table

CE Approved

**CMT ORANGE TOOLS®**

**999.110.00**

Router table dimensions:  
80x60x(h)90cm. - 26,5 kg. weight

Our quality bits have been designed for you, the professional craftsman, to allow you to confidently work at your best. CMT now offers even more possibilities with our professional router table: the perfect place to combine your skills and CMT quality.

The professional router table system has a strong and sturdy MDF laminate work surface measuring 80x60x2,5cm for easy mobility when working. This free standing table sits at a comfortable height of 90cm on solid high gauge steel legs and weighs 26,5 kg.

The plate is already pre-bored for CMT routers CMT7E but is adaptable to all brands and models of routers on the market. Plate can also fit any router bit up to 98mm in diameter. Choose from our wide range of bits, including multi profile and molding bits or even kitchen bit set. Work easily and safely on this table!



**Optional**  
**999.100.11**  
(mandatory for CE legislation)

order separately

DESCRIPTION	ORDER NO.
CMT professional router table system:	<b>999.110.00</b>
Electric safety switch (mandatory for CE legislation)	<b>999.100.11</b>
CMT7E router and 999.110.00 Professional router table + 999.100.11 Electric safety switch	<b>CMT7E-PRO</b>
<b>Parts included with the table:</b>	
1) Plate (pre-bored for CMT7E) with reduction rings	<b>999.110.33</b>
2) Lexan® safety shield	<b>999.110.06</b>
3) Standing spring press	<b>999.110.08</b>
4) Moulded ABS feather board	<b>999.110.09</b>
5) Transversal mitre gauge	<b>999.110.10</b>
<b>Optional:</b>	
Plate with 2 reduction rings not bored (not for CMT routers)	<b>999.110.03</b>

# Industrio Routing System

CE Approved

**CMT ORANGE TOOLS®**

**999.500.01**

CMT has turned the Industrio routing system into a great tool with new accessories such as a phenolic insert, integral aluminium scales and an improved fence. Also, you will find some new optional features, such as a rugged moulded featherboard and a new mitre gauge.

**The system includes:**

**999.501.09**

**Phenolic router table insert plate**

Measuring 298x374mm (11-3/4"x14-3/4"), the phenolic insert plate is 12mm thick and is far more sturdy and resistant to wear and warping than regular melamine surfaces.

The top also features new aluminium scales on both ends for quick and easy fence setup.

**Fast & Easy Bit Change**

No need to remove the router or fumble beneath the table top to change the bits. CMT's useful bent wrench allows you to replace the bits from above quickly and easily. 15 kg. shipping weight.

**999.501.10**

**Pivoting, zero-clearance fence with new clamping system.**

Use the extruded aluminium fence either as a conventional lock-in-place fence or as a pivoting fence. Quick adjusting clamps on both ends make adjustments a breeze especially when used with the aluminium scales featured on the table top. The replaceable centre section on the fence creates zero-clearance inserts and features a sub-fence made of high density white plastic which guarantees an ultra smooth feeding surface. 8.5kg shipping weight.

**999.501.03**

**Sturdy Melamine Cabinet**

Made of 20mm thick melamine, this cabinet is easy to assemble thanks to easy-to-fit screws and cross-dowels. A double-door storage compartment means your tools stay safe and dust-free. 32.5kg shipping weight.

Router table dimensions:  
79x59x(h)93cm. - 55 kg. weight

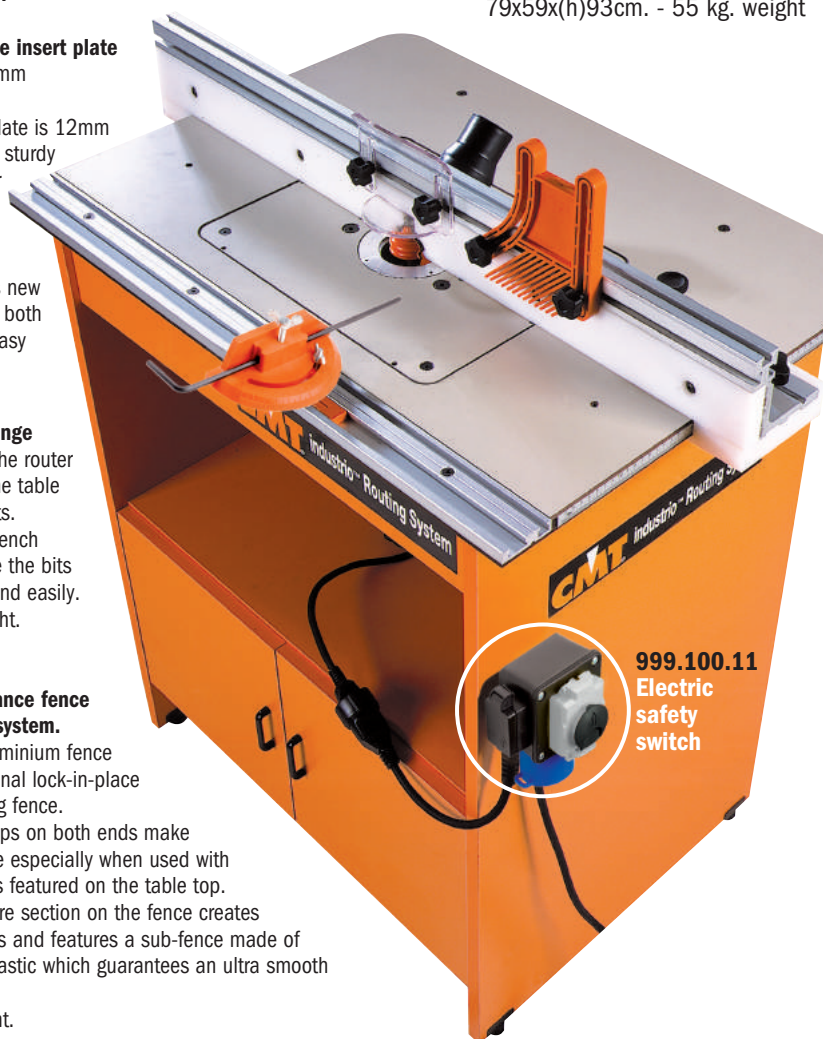

**999.501.07** Moulded ABS featherboard setup on table and in fence slots. Includes nuts, bolts and a plastic slide.



**999.501.08** Mitre gauge.



**999.501.18** Phenolic plate with aluminium rings (Ø103-69,5mm) for CMT7E.



**999.502.34** Centering device to perfect router positioning in the 8-12mm (5/16"-15/32") insert plate.



**999.100.11** Electric safety switch



Watch the video on **YouTube**

**Optional**

Bent wrenches for easy bit replacement

- 17mm .....991.005.00
- 21mm .....991.002.00
- 22,2mm .....991.004.00
- 23,8mm .....991.003.00
- 24mm .....991.006.00\***
- 28,6mm .....991.001.00

\* For CMT7E and CMT8E routers

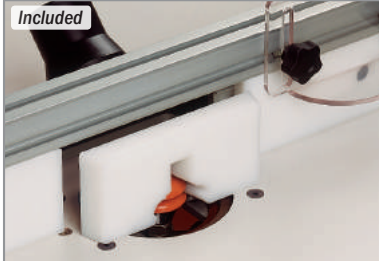

**999.502.10** Central section of the fence is removable for custom replacements.

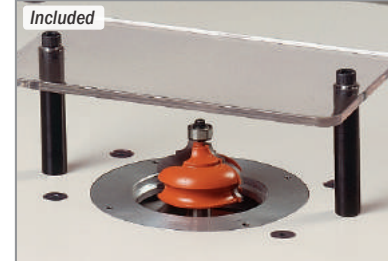

**999.501.06** The dual and post-guard makes freehand work safer.

DESCRIPTION	ORDER NO.
Industrio routing system (with prebored plate for CMT7E)	<b>999.500.01</b>
CMT7E router and 999.500.01 Industrio routing system + 999.100.11 Electric safety switch	<b>CMT7E-IND</b>
Electric safety switch (mandatory for CE legislation)	<b>999.100.11</b>
<b>Optional:</b>	
Universal phenolic plate with aluminium rings (Ø103-69,5mm), not bored (not for CMT routers)	<b>999.501.26</b>
Phenolic plate with (Ø103-69,5mm) aluminium rings for CMT8E router	<b>999.501.27</b>
Pair of (Ø103-69,5mm) reduction rings	<b>999.501.05N</b>



# Pocket-Pro™ Joinery System

# PPJ-002

For fast, easy and accurate cabinet & furniture construction. Designed by CMT and professional cabinetmakers, this new system allows you to make rock-solid pocket hole joints in stock 12,7mm (1/2") to 41,3mm (1-5/8") thick with unprecedented speed and accuracy.

The heart of the Pocket-Pro™ system is our unique moulded jig, which features hardened drill bushings and an interlocking two-piece design. Sliding the jig up or down enables you to adjust the stock thickness in preset 1,6mm (1/16") increments without test joints or measurements! If you have used other pocket hole jigs you will be familiar with many joint applications, but you will benefit from many Pocket-Pro™ system advantages.

**For example:**

- some jigs require adding or removing various parts of the jig to join different stock thicknesses. With the Pocket-Pro™ system you simply have to adjust the interlocking jig up or down for the full range of joints 12,7mm (1/2") to 41,3mm (1-5/8") thick;
- other jigs require frequent repositioning of the depth stop collar for different joint styles. CMT's Pocket-Pro™ joinery system allows you to make most of the adjustments leaving the stop collar in the same position of the drill bit;
- plus, with CMT's Pocket-Pro™ system you can quickly adjust the location of the pocket in relation to the end of your workpiece to create a stronger joint by using longer screws, or to leave more "meat" in the joint.

Check out the Pocket-Pro™ joinery system today. Easy enough for beginners and accurate enough for professional workers, it is the world's most versatile pocket hole jig.



541.095.00 + 515.001.51



999.505.05



999.505.10



990.101X30



999.505.08

DESCRIPTION OPTIONAL	ORDER NO.
500 fine screws L=31,7mm (1-1/4")	<b>990.101X500</b>
500 coarse screws L=31,7mm (1-1/4")	<b>990.102X500</b>
500 fine screws L=38,1mm (1-1/2")	<b>990.103X500</b>
500 coarse screws L=38,1mm (1-1/2")	<b>990.104X500</b>
Face clamp swivel pad	<b>999.505.06</b>
L=76mm (3") square drive screwdriver bit	<b>999.505.07</b>
Phenolic insert plate (for Pocket Pro™)	<b>999.505.04</b>

DESCRIPTION	ORDER NO.
Pocket-Pro™ joinery system set	<b>PPJ-002</b>
<b>Set contains:</b>	
Pocket-Pro™ main parts	<b>999.505.10</b>
Toggle clamp	<b>999.505.05</b>
Ø9,5mm (3/8") step drill bit	<b>515.001.51</b>
Ø9,5mm (3/8") depth collar for step drill bit	<b>541.095.00</b>
L=152mm (6") Square drive screw driver bit	<b>999.505.08</b>
Masterpack 30 screw L=31,7mm (1-1/4")	<b>990.101X30</b>

**Optional**

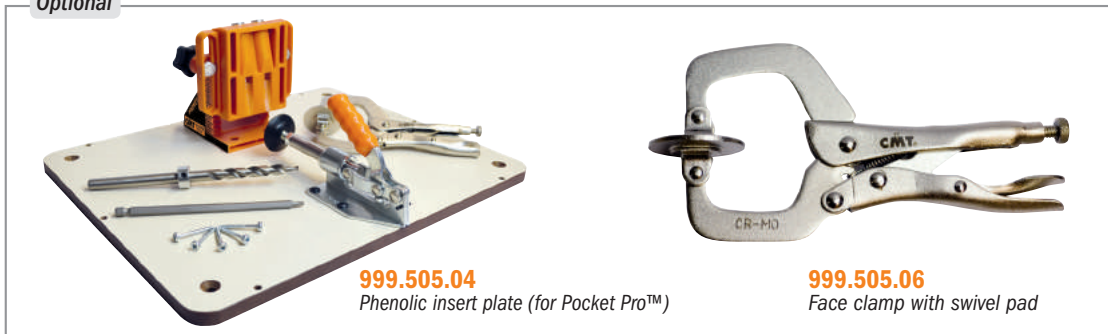

999.505.04  
Phenolic insert plate (for Pocket Pro™)

999.505.06  
Face clamp with swivel pad

### Enjoy Easy Pocket Hole Joinery!

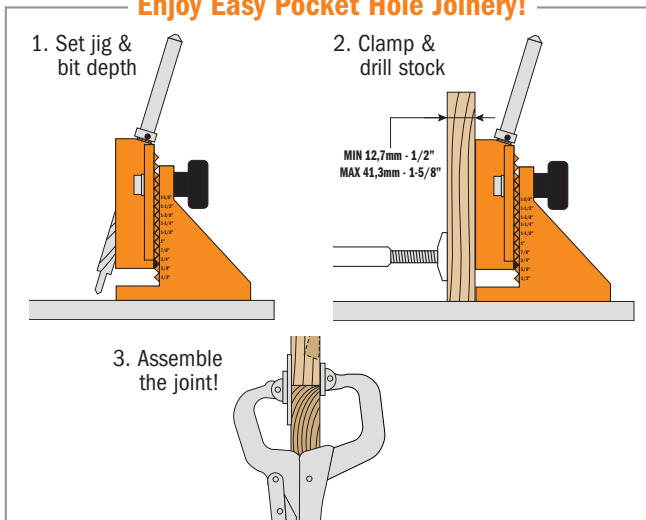

### Build almost anything!

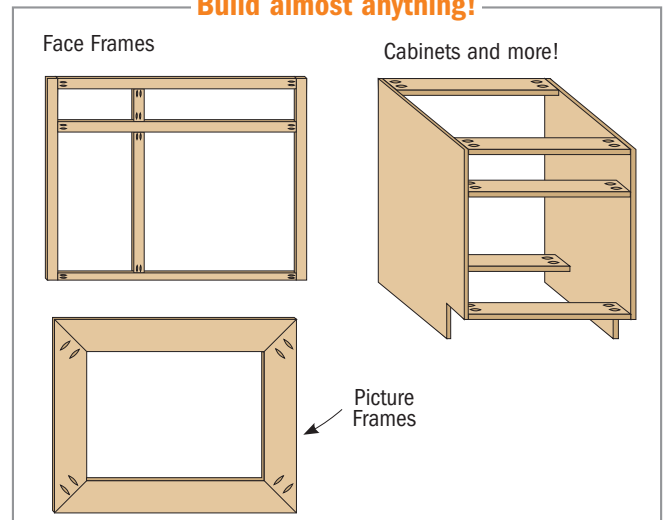

# Small Stock Holder

## PTC-1

By far, handling small stock on your router table is probably one of the most difficult challenges any professional woodworker has to face! Keeping all ten fingers attached to your hands is definitely a priority. This is why the CMT Small Stock Holder is an absolute necessity in the workshop! It safely ensures proper stabilization of smaller work pieces throughout the routing process. The handle grips fitted with comfy silicone inserts keep fingers and hands a safe distance from the blade while the anti-slip lining on both the center and right side base prevents slippage and ensures your workpiece stays put! Fully adjustable and easy to control, the CMT Small Stock Holder can manage small stock up to **216mm. (8-1/2")** in width. The perfect little jig for detail-oriented jobs!

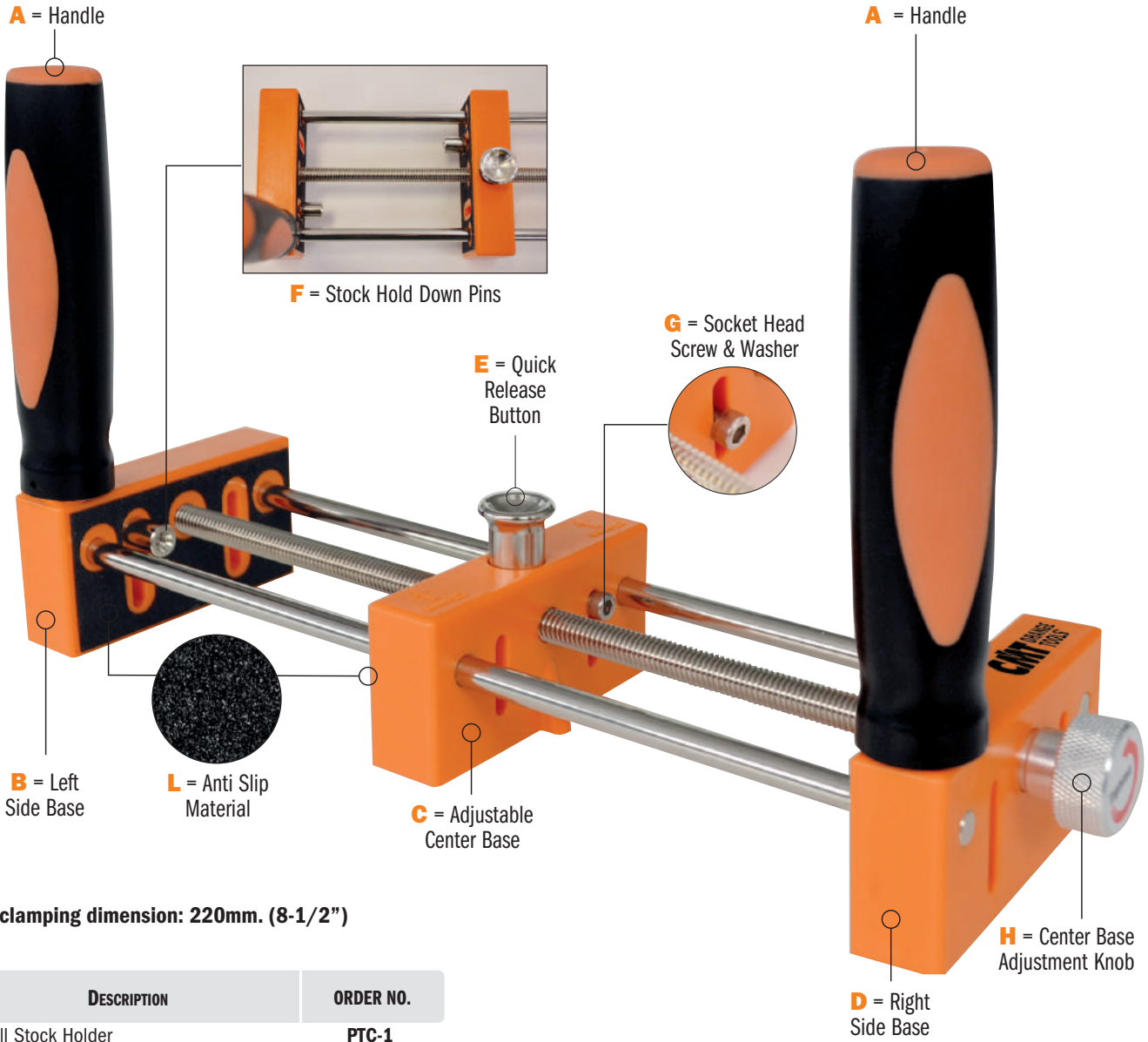

**Max clamping dimension: 220mm. (8-1/2")**

DESCRIPTION	ORDER NO.
Small Stock Holder	PTC-1



1. Lie the Small Stock Holder flat on the work surface. Slide the Hold Down Pins [F] to the top of the slotted holes. Insert the small stock piece between the Adjustable Centre [C] and Left-Side Bases [B]. The end of your small stock piece should lie flat and snugly up against the Left-Side Base. The end must also extend outwards in front of the Small Stock Holder a minimum distance of half the diameter of the router bit in use.



2. Press the Quick Release Button [E]. Slide the Adjustable Centre Base [C] over until it fits snugly against the small stock piece. Release the Quick Release Button. In the image, a "sacrificial piece" is being used to prevent "tear-out". Loosen Hold Down Pins [F] with the Hex Key Wrench provided. Slide Hold Down Pins down until resting firmly against the small stock piece. Tighten pins with Hex Wrench. Rotate Centre Base Knob [H] to further secure your small stock piece.

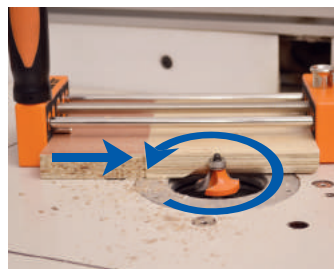

3. Adjust the height of your router bit. When you're ready, power on your router. Take hold of the Small Stock Holder Handles [A], slowly feed your small stock piece into the router opposite to the router bit rotation and always in contact with the router bit bearing guide. When finished routing, press the Quick Release Button [E] and slide the Adjustable Centre Base [C] over so you can remove the small stock piece.

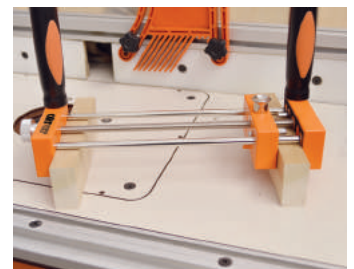

4. Need to rout stock thicker than the Small Stock Holder? Follow setup instructions carefully. Create an "outrigger"- cut a piece of stock, which will act as a stabilizer, the same thickness as the piece you are working on. Attach the "outrigger" securely to the Right-Side Base [D] using pan-head screws (not included) that will fit through the slotted holes. In this way, your work piece and the Small Stock Holder will remain stable during the routing process.

# Professional Straight Edge Clamps

**PGC**

Used as a fence for your bandsaw, drill press or even as an auxiliary fence on your router table or table saw, CMT's professional straight edge clamps represent a two-in-one tool, allowing you to either use them as an edge guide, or to easily clamp your boards or any object for woodworking. Available in different sizes. Here are the main features:

- Made of extruded aluminium for easy carriage and enhanced durability.
- Light, yet more rigid than any other clamps on the market.
- Measuring scales, low-profile jaws, built-in T-tracks on the top allowing the use of accessories or jigs.
- Either single or back-to-back clamps.

DESCRIPTION	ORDER NO.
Professional Straight Edge Clamp 610mm	<b>PGC-24</b>
Professional Straight Edge Clamp 915mm	<b>PGC-36</b>
Professional Straight Edge Clamp 1270mm	<b>PGC-50</b>

Low-profile clamps allow for accurate cuts, dados and grooves. In addition they properly work as an auxiliary fence on your drill press or router table. Sturdy jaws hold your workpiece to the full length of the clamp without any side-to-side play. Back-to-back clamps with the suitable accessories also let you manage your woodworking operations with a lot of versatility. Adjustable scale and two T-tracks allow you to use many accessories.

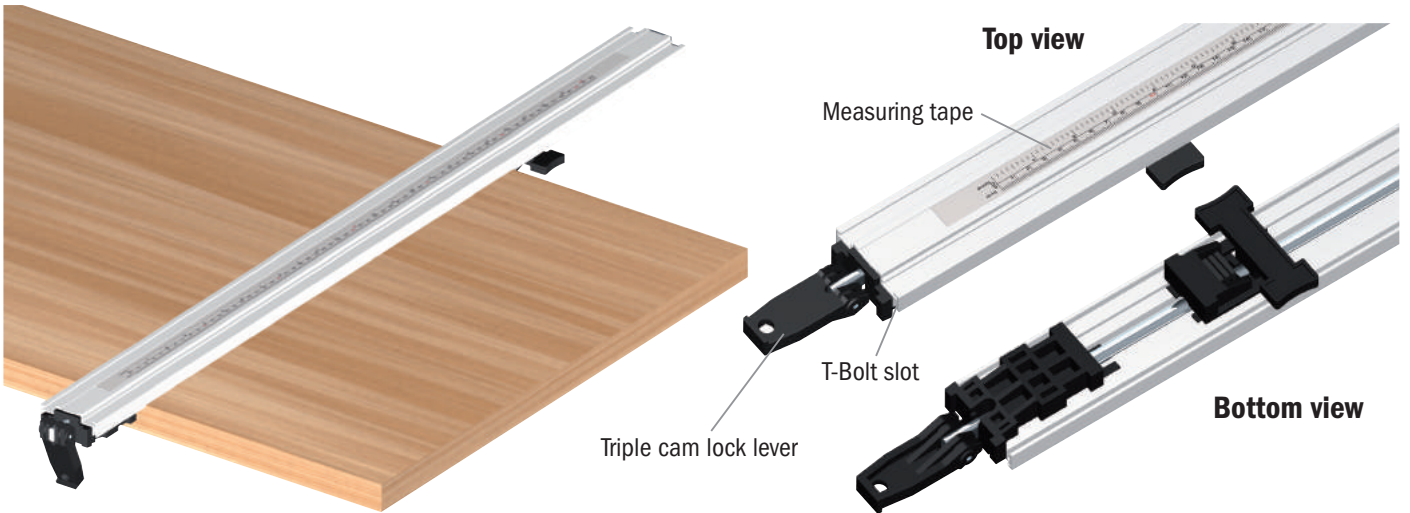

## Back-to-Back Connectors for Straight Edge Clamps (optional)

Lay two more straight edge clamps on the back of the other pair of straight edge clamps and secure them by using your back-to-back connectors. Fasten the bottom jaw pads to the table top and clamp wood with the top jaw pads. Thanks to the low profile jaws your work surface is never obstructed. The back-to-back straight edge clamps can also be taken apart for making two separate clamps.

DESCRIPTION	ORDER NO.
Back to Back Connectors for straight edge clamps (8-Pieces)	<b>PGC-B2B</b>

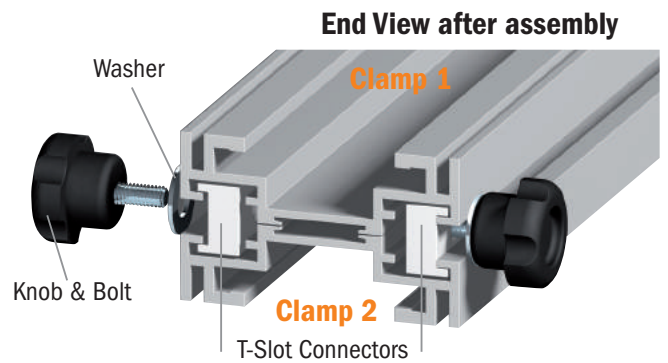



# Adjustable Precision Router Dado Jig

The perfect tool for crafting grooves, dados, and joints. Easy to use and fully adjustable. You can create dados of any size using the same router by simply increasing the number of passes you make. Sturdy construction built to last. Smooth rolling steel rollers are ideal for easy maneuverability and stress-free handling. Compatible with almost any router equipped with 1-3/16" (30mm) bushings or by using the Bushing Template Guides included. (bore baseplate sold separately). Guarantees clean precise dados.

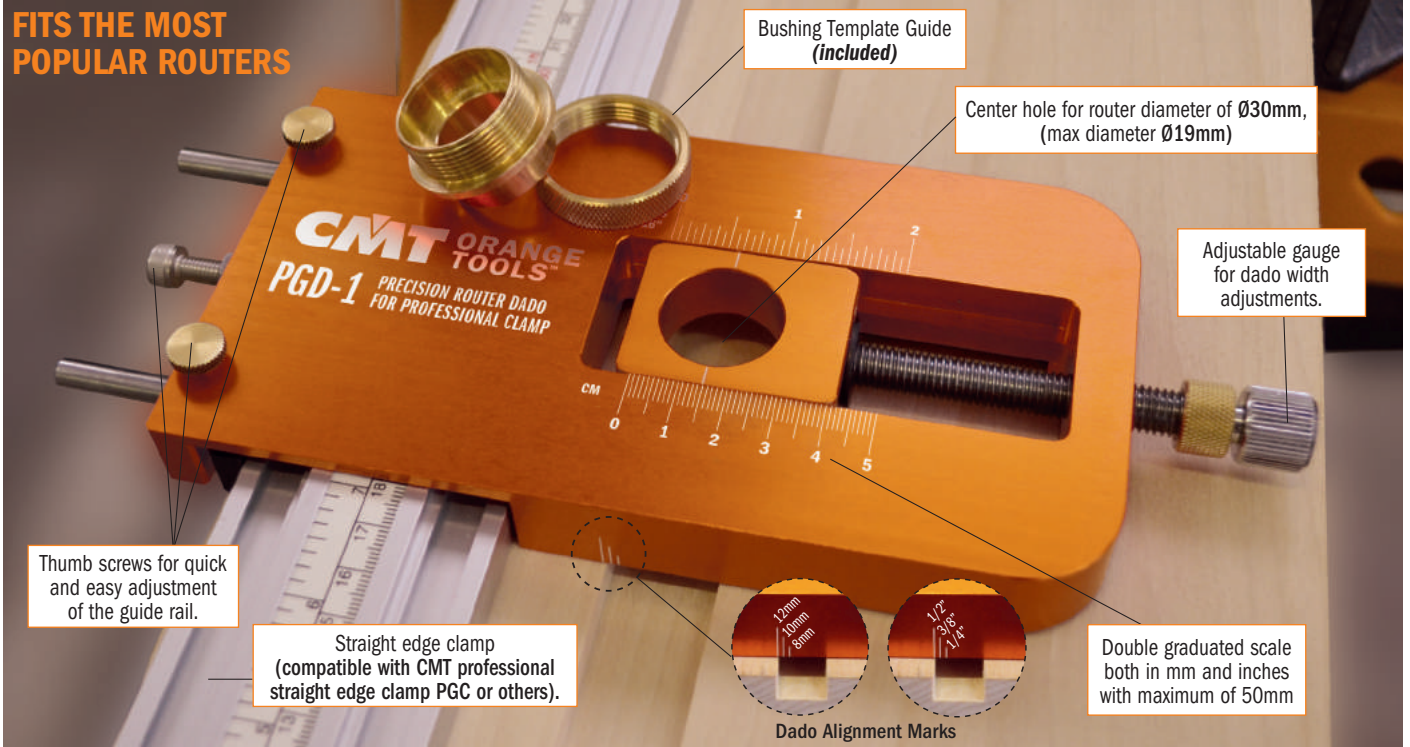

Prepare your router: Install the guide bushing rings into the bore baseplate and then attach it as the base for your router. Select and insert your router bit.

Prepare the Adjustable Guide Rail & Straight Edge Clamp: Position both the adjustable straight edge clamp and then the adjustable precision router dado jig onto your workpiece. Then using the adjustable thumb screws, secure it. Once assembled, ensure that the adjustable precision dado jig slides freely.



Insert your router into the center hole of the adjustable precision router dado jig.

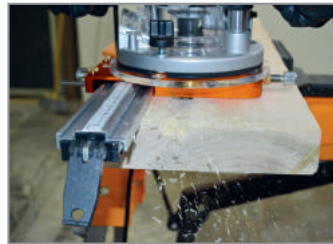

Set your cutting depth by raising or lowering the bit until desired depth is reached. Determine the starting point of the cut you wish to make by using the Dado Alignment Marks on the long sides (width) of the Adjustable Precision Router Dado Jig which indicates the outside edge of the dado cut closest to the straight edge clamp (12-10-8mm front, 1/2", 3/8", 1/4" back).



Holding onto your router in position, power on and begin making the cut by pushing forward and back on the straight edge clamp using the precision router dado jig as a guide. Makes impeccable grooves and dados along the length of your workpiece.



For creating dados that exceed router width, using the adjustable gauge, simply select the desired width on the graduated scale.

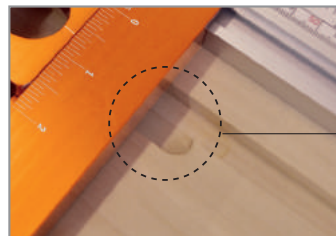

Make as many passes necessary to obtain the desired dado width.

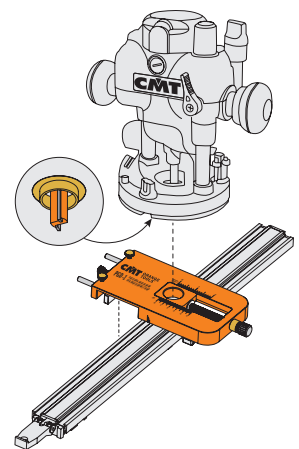
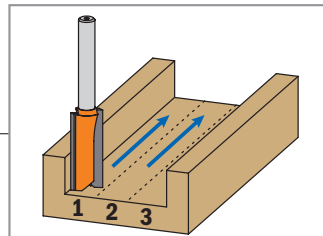

**RECOMMENDED\* (not included)**

Universal Router Base  
899.000.01 or  
899.000.02 Prebored base for CMT7E/CMT8E  
\*Not required for routers with 1-3/16" bushing guide



**RECOMMENDED (not included)**

PGC Straight Edge Clamp with graduated scale (pag. 342)

DESCRIPTION	ORDER NO.
Adjustable Precision Router Dado Jig	PGD-1



# Universal Dovetail Jig

## CMT300

305mm max length  
11~25mm joint thickness

Dovetail joints give a touch of craftsmanship to your work, but many woodworkers avoid these joints, because of their apparent complexity. CMT's new 305mm dovetail jig is the fast easy solution! Thanks to precise templates, permanent stops and easy adjustments, we have taken the "tinkering" out of dovetail joinery. Simply clamp your workpiece in with the edges against the factory-set stops, set your bit depth and then you are ready to rout. Rest assured, we haven't cut corners on quality either. This jig features a rugged steel body, templates, stops and clamping bars that together produce perfect long-lasting joints for all your woodworking needs. The jig accepts stock from 11mm to 25mm in thickness and is capable of crafting a variety of joints with the available templates. The jig comes with a template for 12.7mm half blind joints as well as a template guide. Optional templates are available for through dovetail and box joints.

**RUGGED STEEL TEMPLATE**

**CLOSED SECTION STEEL CLAMPING BAR**

**FACTORY-PRESET STOP**

**STRONG STEEL BODY SOLID SUPPORT**

**EASY-GRIP CLAMPING KNOB**

DESCRIPTION	ORDER NO.
Universal Dovetail Jig	CMT300

**Standard equipment**

- Standard Ø12,7mm silver blind template **CMT300-T128**
- Ø15,8x4mm template guide **899.005.00**

### IMPORTANT TIP



#### HW DOVETAIL BITS (not included):

- 718.127.11** D=12,7mm A=14° S=6mm
- 818.128.11** D=12,7mm A=14° S=6,35mm
- 918.127.11** D=12,7mm A=14° S=8mm
- 818.628.11** D=12,7mm A=14° S=12,7mm

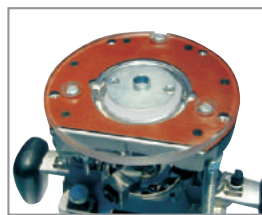

#### Will the template fit my router?

Standard template guide attaches using two screws spaced 50mm on centre. Many routers are compatible with this design. However, if yours is not, choose from the list of universal router bases here below:

#### Universal router bases

- For Ø8 and Ø12mm shank
- For Ø6,35 and Ø12,7mm shank
- Prebored router plate for CMT7E and CMT8E

#### ORDER NO.

- CMT300-SB1**
- CMT300-SB2**
- CMT300-SB**

### Here's how it works:



## Half Blind Template **CMT300-T064**

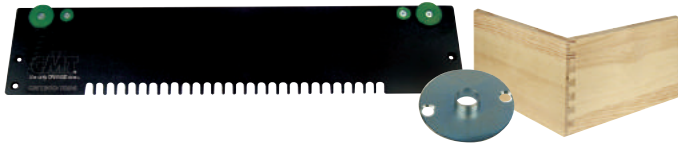

TEMPLATE LENGTH mm	DOVETAIL SIZE mm	THICKNESS mm	COLOUR	ORDER NO.
300	6,3	8 ~ 12	green	<b>CMT300-T064</b>

Supplied with Ø7,8x4mm precision guide

To be used with CMT dovetail router bits:  
 Ø6x8mm HW bit (Ø6mm shank)  
 Ø6,35x8,3mm HW bit (Ø6,35mm shank)



**899.003.00**

**718.060.11**

**818.064.11**

## Box Joint Templates **CMT300-T080 - CMT300-T127**

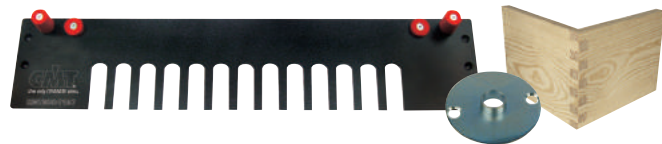

TEMPLATE LENGTH mm	DOVETAIL SIZE mm	THICKNESS mm	COLOUR	ORDER NO.
300	8	8 ~ 20	blue	<b>CMT300-T080</b>

Supplied with Ø11,1x4mm precision guide

To be used with CMT straight router bits:  
 Ø8x25mm HW bit (Ø6,35mm shank)  
 Ø8x30mm HW bit (Ø8mm shank)



**899.004.00**

**811.081.11**

**912.080.11**

TEMPLATE LENGTH mm	DOVETAIL SIZE mm	THICKNESS mm	COLOUR	ORDER NO.
300	12,7	8 ~ 20	red	<b>CMT300-T127</b>

To be used with CMT straight router bits:  
 Ø12,7x30mm bit HW (Ø6,35mm shank)  
 Ø12,7x30mm bit HW (Ø8mm shank)  
 Ø12,7x25mm bit HW (Ø12,7mm shank)



**812.127.11**

**912.127.11**

**811.627.11**

## Through Dovetail Templates **CMT300-T129 - CMT300-T190**

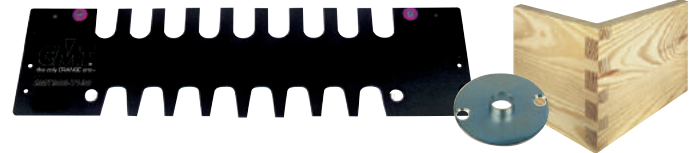

TEMPLATE LENGTH mm	DOVETAIL SIZE mm	THICKNESS mm	COLOUR	ORDER NO.
300	12,7	8 ~ 20	brown	<b>CMT300-T129</b>

Supplied with Ø11,1x4mm precision guide

To be used with CMT straight router bits:  
 Ø8x25mm HW bit (shank Ø6,35mm)  
 Ø8x30mm HW bit (shank Ø8mm)



**899.004.00**

**811.081.11**

**912.080.11**

To be used with CMT dovetail router bits:  
 Ø12,7x20mm HW bit (Ø6,3mm shank)  
 Ø12,7x20mm HW bit (Ø8mm shank)

**818.129.11**

**918.129.11**

TEMPLATE LENGTH mm	DOVETAIL SIZE mm	THICKNESS mm	COLOUR	ORDER NO.
300	19	15 ~ 22	violet	<b>CMT300-T190</b>

Supplied with Ø22x4mm precision guide

To be used with CMT straight router bits:  
 Ø12,7x30mm HW bit (Ø6,35mm shank)  
 Ø12,7x30mm HW bit (Ø8mm shank)  
 Ø12,7x25mm HW bit (Ø12,7mm shank)



**899.006.00**

**812.127.11**

**912.127.11**

**811.627.11**

To be used with CMT dovetail router bits:  
 Ø19x22mm HW bit (Ø6mm shank)  
 Ø19x22mm HW bit (Ø6,35mm shank)  
 Ø19x22mm HW bit (Ø8mm shank)  
 Ø19x22mm HW bit (Ø12mm shank)  
 Ø19x22mm HW bit (Ø12,7mm shank)

**718.190.11**

**818.190.11**

**918.190.11**

**918.690.11**

**818.690.11**

### Precision guide for router:

DIAMETER	ORDER NO.
7,8 x 4mm	<b>899.003.00</b>
11,1 x 4mm	<b>899.004.00</b>
15,8 x 4mm	<b>899.005.00</b>
22 x 4mm	<b>899.006.00</b>
27 x 6mm	<b>899.008.00</b>
30 x 6mm	<b>899.007.00</b>

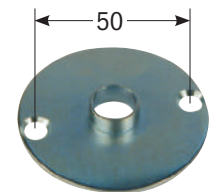

## Here are a few of the beautiful dovetail joints you can produce using CMT bits

Half blind

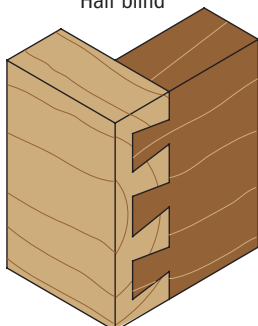

**CMT300 - T064**  
**CMT300 - T128** (INCLUDED with CMT300)

Box joint

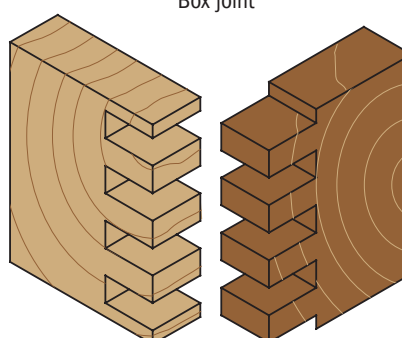

**CMT300 - T080**  
**CMT300 - T127**

Through dovetail

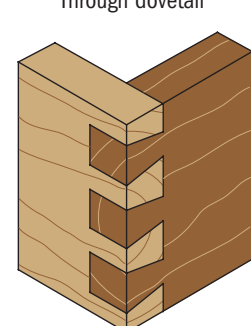

**CMT300 - T129**  
**CMT300 - T190**

## CMT3000

This product has been designed for cutting ellipses and circles with any type of router. You can make ellipses and circles for windows, doors and any other application. By using two slides into the T-slot you can cut ellipses, whereas if you use one slide, you can cut circles.



Slider in the T-slot of the cross frame

### CMT3000 ellipse jig includes:

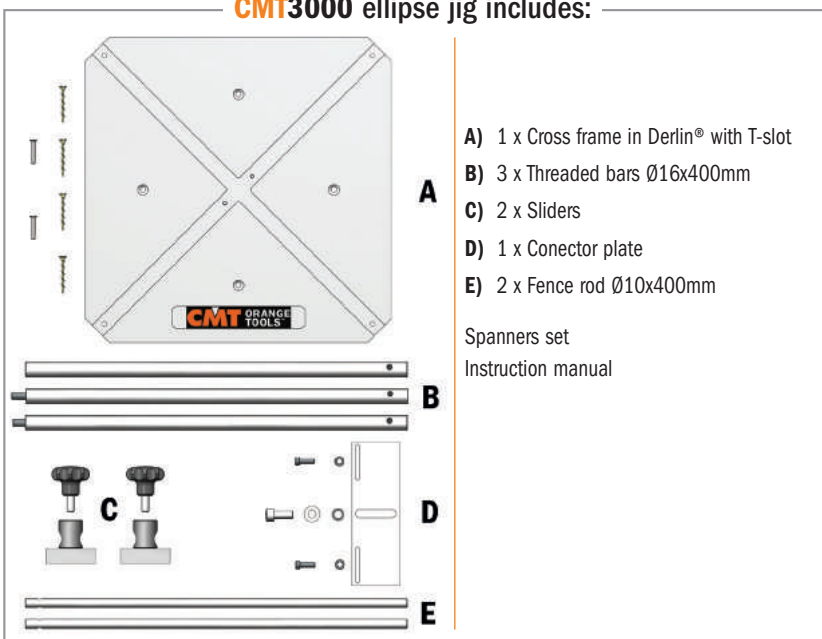

### Ellipse and circle cutting jig:

- Precise and rapid creation of ellipses and circles.
- Simple setup and effective operating.
- Clamping system for any type of routers.
- Special plastic cross frame with excellent sliding performance.
- Precisely machined T-slots and steel sliders.
- Zinc-coated metal parts to prevent rust.
- Delivered in a carton box along with instruction manual.

Major axis	Minor axes	
	Max	Min.
3000	2890	2590
1800	1690	1390
1500*	1390	1090
1030	920	620
900	790	620
730	620	620
*Min/Max radius routing with standard equipment		550/1500
Package dimension (mm)		445x360x85
Weight		6 kg.

### Here are a few examples you can create using CMT3000 Ellipse

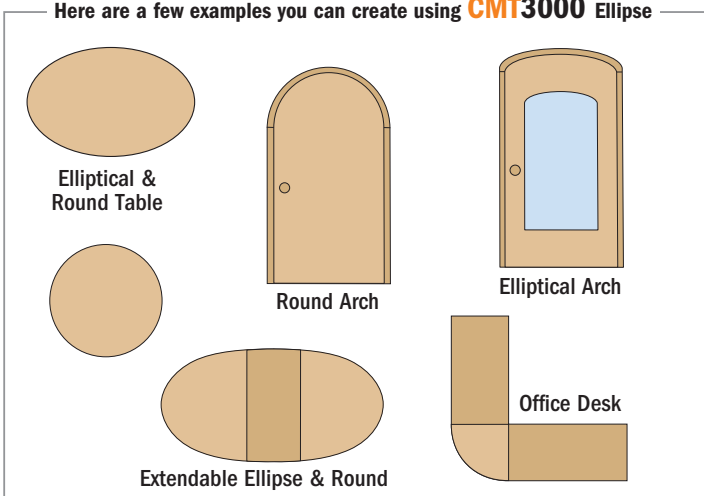

### Optional



#### CMT3000-SB1

Ø170x15mm Delrin® guide plate for CMT3000 to be used with CMT7E & CMT8E

DESCRIPTION	ORDER NO.
Ellipse & Circle Cutting Jig	CMT3000
<b>Optional:</b>	
400mm robust bar to extend the working radius	CMT3000-7
2-Pcs. of fence rod for routers with bars up to Ø8mm in diameter	CMT3000-8
Ø170x15mm Delrin® guide plate for CMT3000 to be used with CMT7E & CMT8E	CMT3000-SB1



# CMT650

**For perfect joints**

For kitchen worktops from 420mm to 650mm in width.

**CMT650** is designed to cut kitchen worktop joints with any type of router.

Letter code system for different operations makes the jig work much easier and very quick.



Dimensions:  
880x300x 10mm.



**Joints made in 15 minutes! Including setup time**

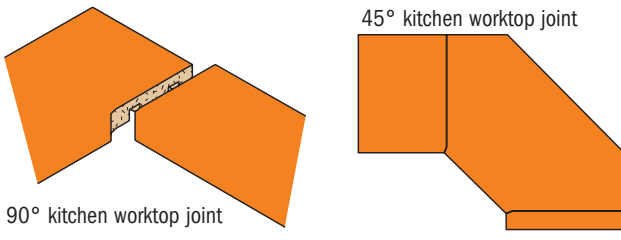

**JIG INCLUDES:**

- 1pc. Phenolic template
- 3pc. Zinc-coated steel location bush
- 1pc. Adjustable end stop
- 1pc. Instruction manual

**Optional**

- Portable router
- Guide bush Ø30mm\*
- HW straight bit Ø12mm
- Two clamps

**\* COMBINATION ROUTERS/ACCESSORIES**

Router	Bush guide	Base Plate
CMT7E	899.007.00	CMT300-SB
CMT8E	899.007.00	CMT300-SB
NO-CMT	899.007.00	CMT300-SB1

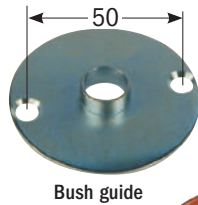

Bush guide

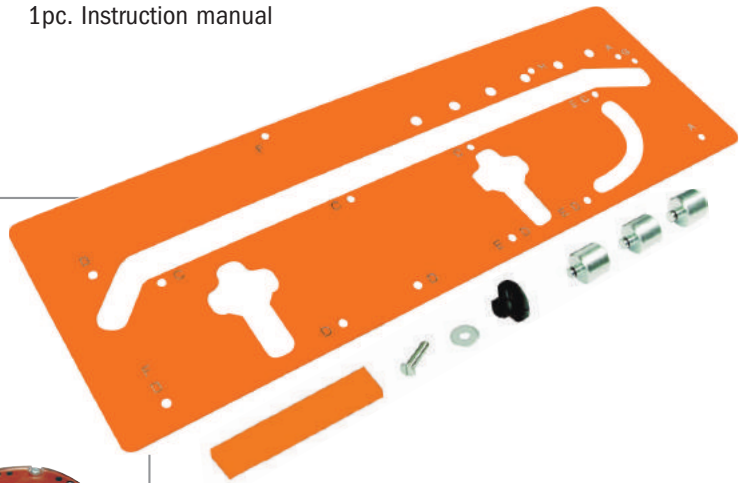

Base plate



**652**



**8/912**

**Bits for the jig:**

We recommend the use of these Ø12mm straight bits:

ORDER NO.	DESCRIPTION
912.120.11	Ø12x31,7 S=8mm
652.120.11	Ø12x28,3 S=8mm
912.621.11	Ø12x38,1 S=12mm
912.622.11	Ø12x50,8 S=12mm
812.620.11	Ø12x31,7 S=12,7mm
812.621.11	Ø12x38,1 S=12,7mm
652.121.11	Ø12x48,3 S=12mm
652.621.11	Ø12x48,3 S=12,7mm

**CMT650 is designed for Ø12mm straight bits.**

- Template made of stable and hardened material.
- For 90° and 45° joints
- Integrated templates for rounding over and chamfering edges.
- Extra location bush for worktop width of 600mm.
- Two integrated templates for panel bolt recesses.
- Delivered with a clear and comprehensive instruction manual.

DESCRIPTION	ORDER NO.
Kitchen Worktop Jig	<b>CMT650</b>



# Universal Hinges Boring System

The innovative CMT333 hinge boring system with 3 spindle-heads allows you to bore holes for any hinge brand. The universal modular base supports the installation of many boring heads, engineered by the worldwide leading company in industrial boring machines. Use the CMT333 universal hinge boring system on all hand-held or standing drilling power tools.

**CMT333**

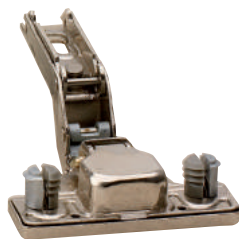

COMPATIBLE WITH MANY HINGE TYPES

Ø8mm/hexagonal shank suitable for any drilling machine

Depth lock

Ground chromium plated slide bars

Greasing point

Double screws for drill clamping

**BORING HEAD NOT INCLUDED**

Choose from one of these options:

- CMT333-4211
- CMT333-4595
- CMT333-4809
- CMT333-4300
- CMT333-4806
- CMT333-5255
- CMT333-3875
- CMT333-325

Slide bar for panel setting

Plywood base

Ø10mm bores for panel setting bars



For use on standing drilling machines



To use on standing drilling power tools



For use on CMT Industrio router table

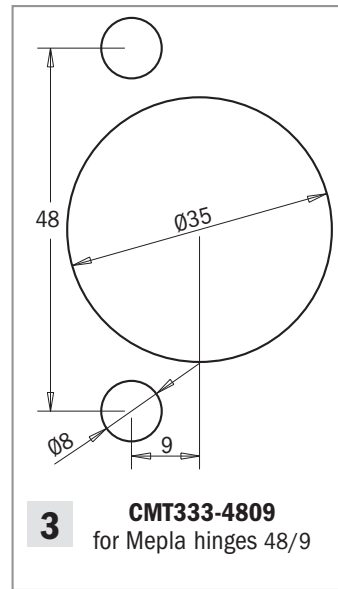
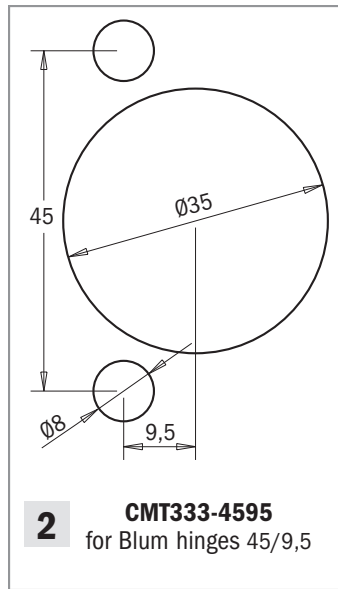
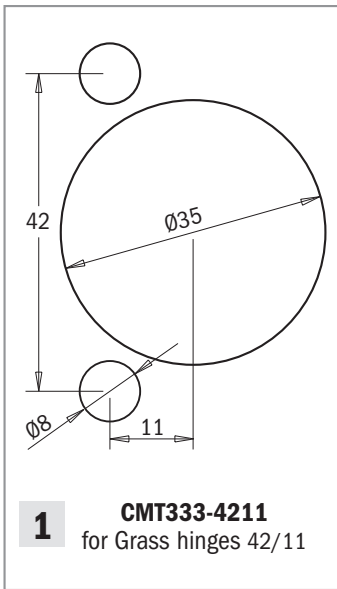

### TECHNICAL FEATURES AND SPECIFICATIONS

- Complete anti-rust parts
- Ground aluminium (Avional)
- Max 5000 RPM
- Six radial antifriction bearings

### SAFETY TIPS:

for lubrication use oil SHC100 Mobil

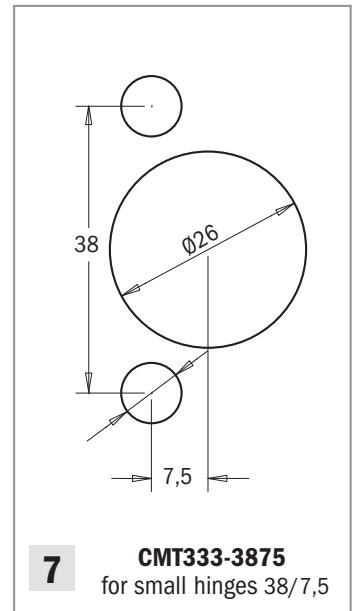
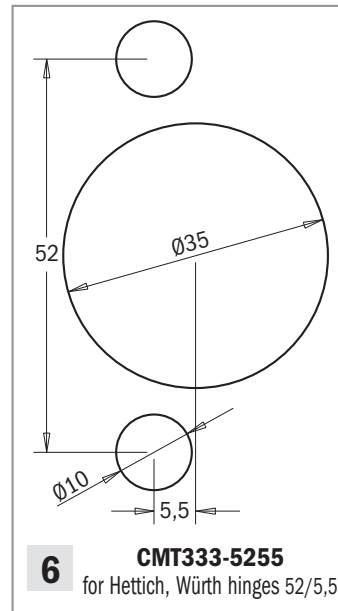
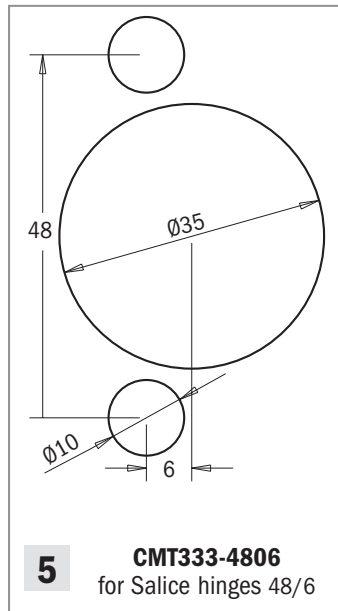
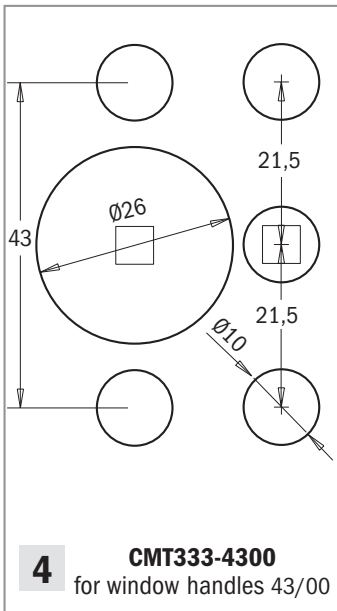

## MAXIMUM VERSATILITY FOR ANY BRAND

Support modular base	Boring heads	Drill bits	Boring bit
<b>ORDER NO.</b>	<b>ORDER NO.</b>	<b>S</b>	<b>ORDER NO.</b>
<b>CMT333</b>	<b>CMT333-4211</b>	8mm	<b>310.080.12</b> (2 pcs.)
<b>CMT333</b>	<b>CMT333-4595</b>	Hexagonal	<b>310.080.12</b> (2 pcs.)
<b>CMT333</b>	<b>CMT333-4809</b>	8mm	<b>310.080.12</b> (2 pcs.)
<b>CMT333</b>	<b>CMT333-4300</b>	Hexagonal	<b>310.100.12</b> (2 pcs.)
<b>CMT333</b>	<b>CMT333-4806</b>	8mm	<b>310.100.12</b> (2 pcs.)
<b>CMT333</b>	<b>CMT333-5255</b>	Hexagonal	<b>310.100.12</b> (2 pcs.)
<b>CMT333</b>	<b>CMT333-3875</b>	8mm	<b>310</b> your choice (2 pcs.)
<b>CMT333</b>	<b>CMT333-325</b>	Hexagonal	(3 pcs. RH + 2 pcs. LH)

**Make your set**

**Choose your hinge**

1	Grass	42/11
2	Blum	45/9,5
3	Mepla	48/9
4	Window handles	43/00
5	Salice	48/6
6	Hettich, Würth	52/5,5
7	Small hinges	38/7,5
8	System 32	32

## Boring head System 32

The universal modular base supports the installation of the System 32 with 5 adapters, engineered by the worldwide leading company in industrial boring machines. Use the CMT333 universal hinge boring system on all hand-held or standing drilling power tools.

**CMT333-325**

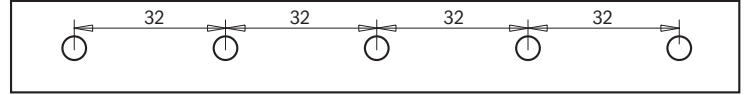

DESCRIPTION	ORDER NO.
Boring head with 5 adapters for system 32	<b>CMT333-325</b>

## Blum Hinges Boring Head

The innovative CMT334 Universal Hinge Boring Head features three spindles which allow you to bore the holes for all of the major hinge brands. The head can be utilized on boring and point to point machines.

**CMT334**

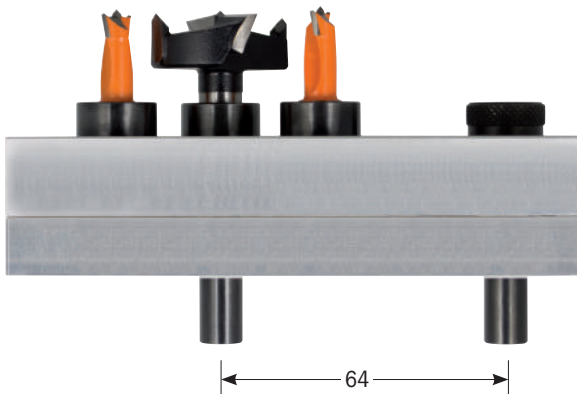

For use on boring and point to point machines.

Standard

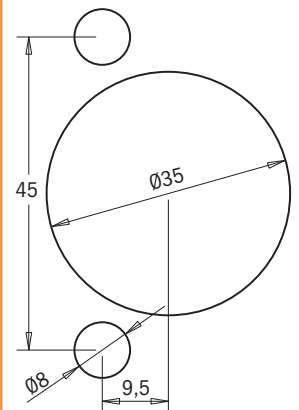

DESCRIPTION	ORDER NO.
Hinge Boring Head (bits not included)	<b>CMT334-4595</b>
Boring Bit Ø35mm x 38,5mm. Right-hand rotation	<b>393.350.11</b>
Dowel Drill Ø8mm x 38,5mm. Left-hand rotation	<b>393.080.12</b>

**CMT334-4595**  
for Blum hinges 45/9.5

## Bench Block Set

These blocks are great for holding your workpiece without any clamps. Their anti-slip surface grip both your bench top and the underside of your workpiece. Raise your work above the bench and benefit from plenty of clearance for your router bits, cutters, etc.

Length: 75mm  
Width: 50mm  
Height: 25mm

**BBS-001**



DESCRIPTION	ORDER NO.
Bench block set (4-Pcs.) 75x50x25	<b>BBS-001</b>



# CMT Inlay Kit

**899**

Beautiful, professional-quality inlays aren't as difficult as they seem. In fact, they are easy with the CMT inlay kit. Just remove and reassemble the small bushing to make the recess in the workpiece and cut out the inlay. Perfect for toy making, puzzle making, lettering and lots of other decorative projects. Use the spiral bit for routing MDF, or the straight bit for natural wood.

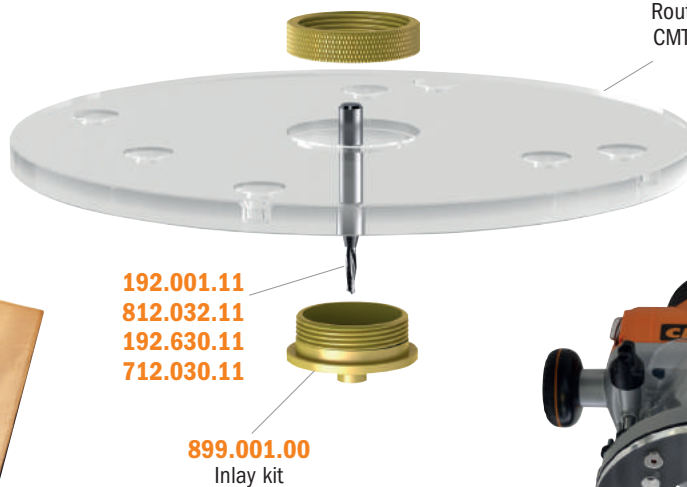

**899.000.02**  
Router base for CMT7E/CMT8E

**192.001.11**  
**812.032.11**  
**192.630.11**  
**712.030.11**

**899.001.00**  
Inlay kit



Complete instructions for assembling and using CMT inlay kit are included.

DESCRIPTION		ORDER NO.
Inlay kit with 3,2mm (1/8") HWM spiral bit	(Ø6,35mm shank)	<b>899.051.00</b>
Inlay kit with 3,2mm (1/8") HWM straight bit	(Ø6,35mm shank)	<b>899.052.00</b>
Solid brass template guide		<b>899.001.00</b>
Universal router base		<b>899.000.01</b>
Router base for CMT7E/CMT8E		<b>899.000.02</b>
3,2mm (1/8") HWM spiral bit	(Ø6,35mm shank)	<b>192.001.11</b>
3,2mm (1/8") HWM straight bit	(Ø6,35mm shank)	<b>812.032.11</b>
3mm HWM spiral bit	(Ø6mm shank)	<b>192.630.11</b>
3mm HWM straight bit	(Ø6mm shank)	<b>712.030.11</b>

# Template Guide Kit

A practical 7-bushing kit that will extend the possibilities of your router. For template-controlled operations such as dovetailing, stair routing, hinge butt routing, lock face routing and more general template tasks.

These template guides can be used with any router featuring a 30mm (1-3/16") bore baseplate. Fits the most popular routers. Some routers require CMT's base 899.000.02.



# CMT-TGA

Optional

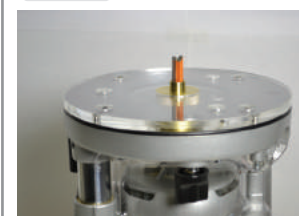

DESCRIPTION	ORDER NO.
Prebored base for CMT7E and CMT8E	899.000.02
Universal base	899.000.01

DESCRIPTION	ORDER NO.
Template Guide Kit	<b>CMT-TGA</b>

Set contains:

QTY.	1	1	1	1	1	1	1	2	1
Internal diameter	15,87mm	16,66mm	13,49mm	10,31mm	8,73mm	7,14mm	6,35mm	Lock Nut	Adapter
Outside diameter	20,24mm	19,05mm	15,87mm	12,7mm	11,11mm	9,52mm	7,93mm	Lock Nut	
Height	14,28mm	14,28mm	14,28mm	7,93mm	3,96mm	7,93mm	3,96mm		



**For dowelling into surfaces  
and shelf supports  
and hinges**

# Universal Boring Template

CMT's universal boring template has been designed for precise and productive manual dowelling of furniture elements by using 32mm Euro-System screws, for boring shelf supports with 3mm or 5mm diameter and for making and marking hinge holes.

By using this template you can prebore the most popular hinge types and also to bore holes for pivots, wooden screws and hinges on the base element, as well as prebore door hinges, included the marking of holes featuring 35mm in diameter for hinges.

This template will guarantee high precision work and productivity and has been designed to be used in pair with the specific CMT400-1 boring adapter supporting any Ø8mm shank drill bits featuring different diametres.

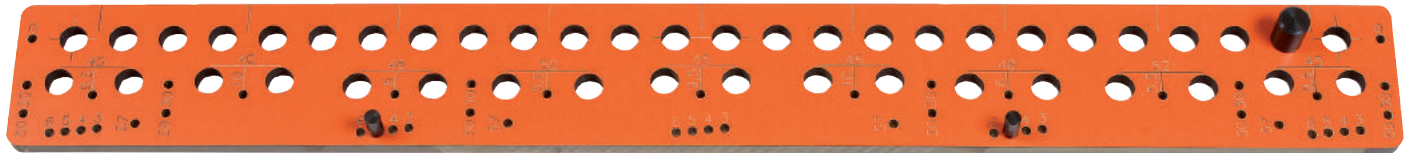

**Laminated phenolic material**

**Clear and comprehensible template marking**

**Precise end stops**



**BORING ADAPTERS (not included):**

- End stop for different boring depths
- Suitable for any type of drilling machine
- Duralumin body with holes for better chip ejection
- Precise and flat seating for proper alignment.

ORDER NO. **CMT400-1**

Boring adapter for **CMT656, CMT900 JIGS**

to be used with drill bits up to 30mm depth:

306.030.21 - 306.050.11 - 306.080.11

**QUICK AND EASY:**

**TECHNICAL DETAILS:**

**CMT900**

Max. board width in one tightening: ..... 900mm

Max board width: ..... no limits

Board thickness: ..... no limits

For dowels: ..... Ø8mm

Hole distance: ..... 32mm

Number of holes: ..... 26

For shelf support: ..... Ø3mm, Ø5mm

For hinges: ..... Ø3mm for wooden screws  
Ø5mm for Euro screws



**HW DOWEL BITS (not included):**

DESCRIPTION			ORDER NO.
D=3x18mm	S=8x20mm	HWM	306.030.21
D=5x30mm	S=8x20mm	HW	306.050.11
D=8x30mm	S=8x20mm	HW	306.080.11

Other sizes available in 306-307 series

Boring into a surface for dowel joints using the template.

Boring Ø3mm and Ø5mm holes for shelf supports.

Preboring holes for hinges (base and panel).

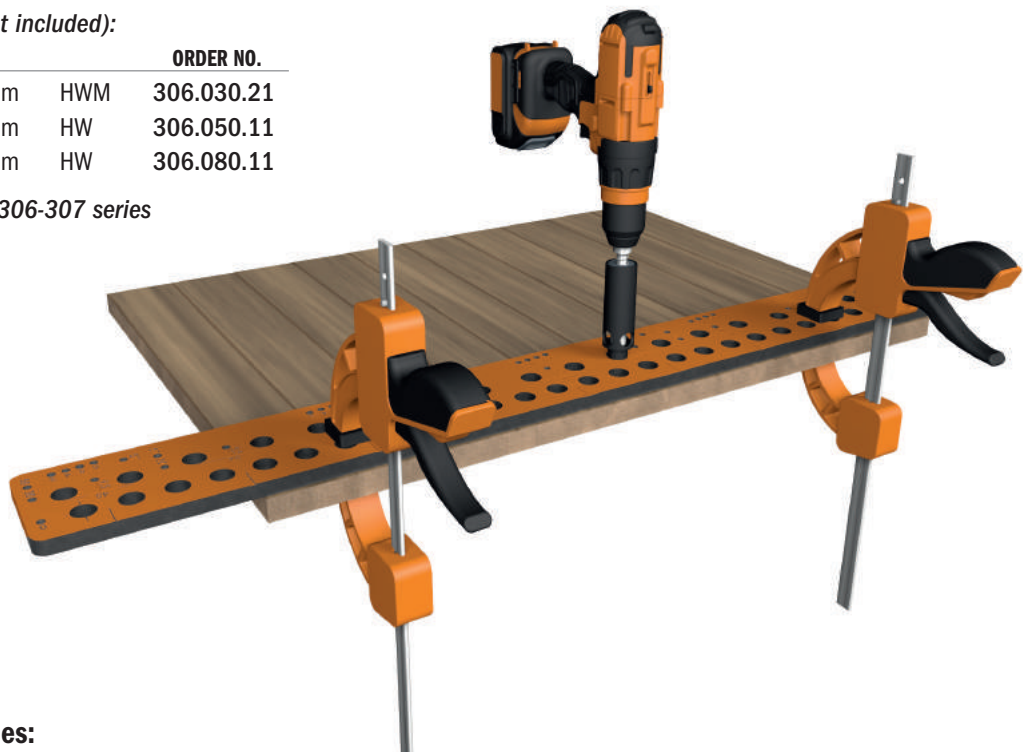

**CMT900 Boring Template Includes:**

- Boring template from laminated pertinax
- End stop set
- End stop set for large elements
- Centering pin for hinges

DESCRIPTION	ORDER NO.
Universal Boring Template	CMT900

# Universal Boring Jig



This universal boring jig has been designed for precise and productive manual dowelling of furniture elements and guarantees high precision work and productivity. The holes have been made with a distance of 32mm between one another, in compliance with the European regulations for doweling machine production. Also, the dowel jig fits CMT Ø8mm shank HW drill bits, clamped into a special boring adapter.

## CMT656

Precise holes  
Detachable end stops  
Ergonomic manual tighteners  
Precise and flat Duralumin profile

**For edge dowelling and jointing**

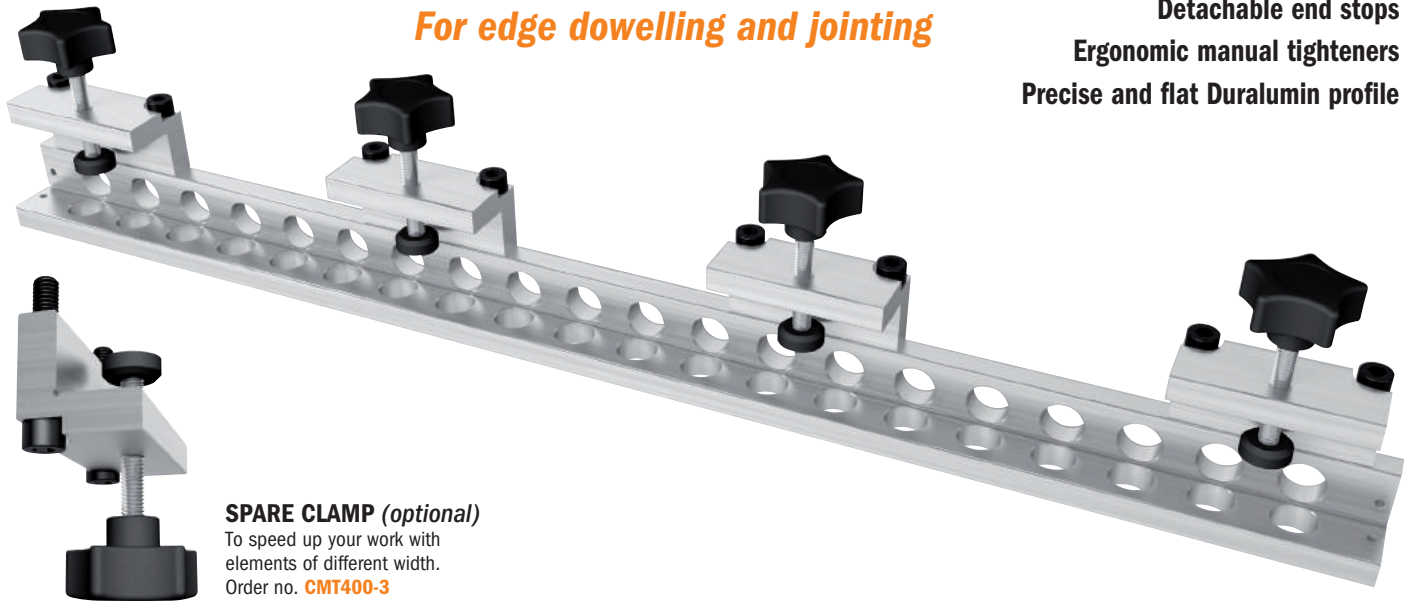

**SPARE CLAMP (optional)**  
To speed up your work with elements of different width.  
Order no. **CMT400-3**

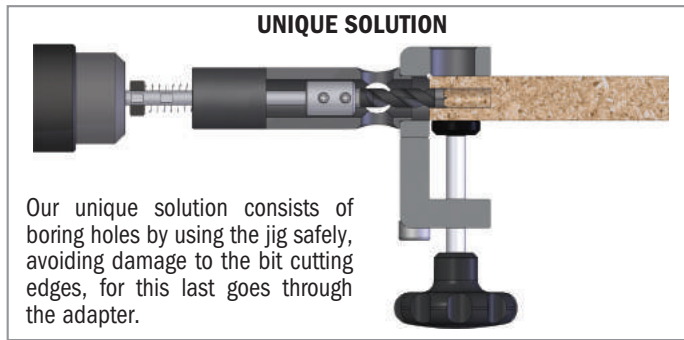

### BORING ADAPTERS (not included):

- End stop for different boring depths
- Suitable for any type of drilling machine
- Duralumin body with holes for better chip ejection
- Precise and flat seating for properly alignment.

ORDER NO. **CMT400-1**

Boring adapter for **CMT656, CMT900 JIGS**

to use with drills bit:

**306.030.21 - 306.050.11 - 306.080.11 - 307.050.11**

ORDER NO. **CMT400-2** (for screw joints)

Boring adapter for **CMT656, CMT900 JIGS**

to use with the drill bit: **307.050.11**

### 3 easy steps in creating dowel joints



Place the jig onto the board, fix the end stop and tighten the workpiece. Set the bore depth and clamp the boring adapter on your drilling machine. Bore vertical holes.



Fasten the jig on the other element, fix the end stop and set the bore depth. Bore horizontal holes.



Now insert the dowels with glue into the holes and join both elements.



As an alternative, use through hole bits and screw the elements together.

### HW DOWEL BITS (not included):

DESCRIPTION	ORDER NO.
D=3x18mm S=8x20mm HWM	306.030.21
D=5x30mm S=8x20mm HW	306.050.11
D=8x30mm S=8x20mm HW	306.080.11
D=5x40mm S=8x20mm HW	307.050.11 for screw joints
D=7x40mm S=8x20mm HW	307.070.11 for screw joints

Other sizes available in 306-307 series

### TECHNICAL DETAILS: .....CMT656

Max board width in one tightening: .....656mm  
For dowels: .....Ø8mm  
For through holes: .....Ø7mm  
Hole distance: .....32mm  
Number of Ø18mm holes : .....2x20  
Board thickness: .....16-40mm  
Facet (elements lap): .....0,8mm

DESCRIPTION	ORDER NO.
Universal Boring Jig (656mm in one tightening)	<b>CMT656</b>

# 3D Router Carver System

**Exclusively from your CMT distributor**

**RCS**

**Turn your router into a remarkable carving tool. It's fast, easy, and a whole lot of fun!**

Who says that intricate woodcarving requires an artist's touch? Thanks to the patented 3D Router Carver system, anyone with a plunge router can create any of the beautiful designs shown on these pages in just minutes. Decorate doors, drawers, cabinets, furniture or just about any flat wooden surface with one or more of these designs. How does it work? The secret is in the 3D Router Carver Bit and the way that bit interacts with the carving templates. The V-Groove router bit is enclosed in a 45° cone-shaped guide. You rout with the plunge mechanism of your router **unlocked**, allowing the bit to move up or down as the router moves forward. As the slot in the template get wider, the bit moves down, producing a wider, deeper V-groove. As the slot gets narrower, the bit moves up, and the groove gets narrower and shallower. It sounds simple, and it is! (that's why the system is patented worldwide). Please see the illustrations below for more details on the carving technique. You'll receive complete instructions with your 3D Carver templates. For an informative visual demonstration, check out the 3D Router Carver video on our web site.

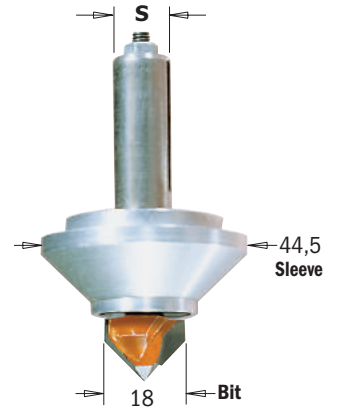





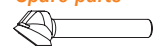

## What do you need to get started?

- The 3D Router Carver bit
- The Carver template of your choice
- The Holding frame to match your template
- Your plunge router

(Note: Be sure the opening in the base of your router is at least 47,6mm in diameter. If it isn't, you'll need to make a sub-base to accept the large diameter of the 3D Carver bit.)

## 3D Router Carver Bit & Sleeve

S mm	ORDER NO. Right-hand rotation	Spare parts					Optional	
8	<b>RCS-BIT8</b>	 RCS-CUT8	 RCS-SLE8	 RCS-SHIELD	 990.091.00	 990.092.00	 991.007.00	 RCS-SLEEVE8
12,7	<b>RCS-BIT</b>	RCS-CUT	RCS-SLE	RCS-SHIELD	990.091.00	990.092.00		RCS-SLEEVE

## Here's how it works:

1. Clamp or tack the holding frame to your workpiece

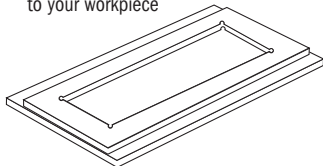

2. Drop the template into a

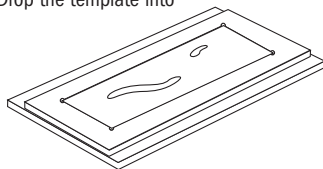

3. Plunge the bit into a wide part of the slot and rout with the router's plunge mechanism unlocked.

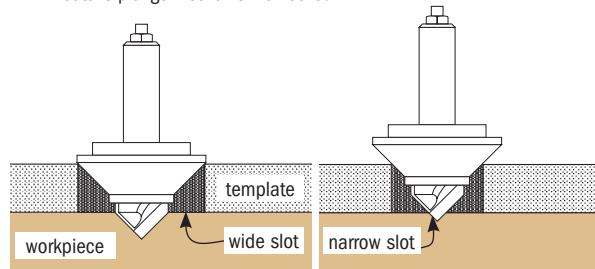

Allow the plunge mechanism to move up and down as you advance. Wider template slots allow wider, deeper grooves. Narrower slots produce shallower grooves.

4. With the frame still in place, flip the template & rout again. Some templates will be routed 2 to 4 times, depending on the complexity of the design.

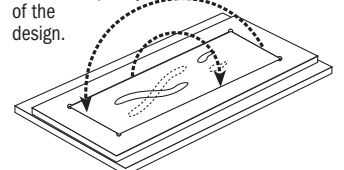

5. Remove the frame and you're finished!

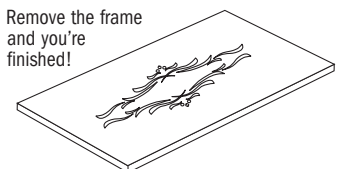

## Cabinet door & panel carvings

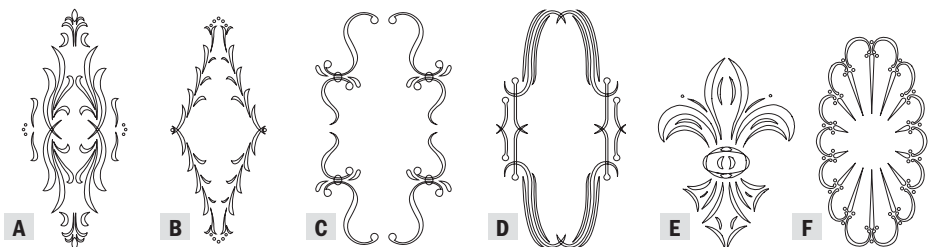

These designs are ideal for the doors or panels of cabinets, entertainment centers, fireplace surrounds or almost any flat surface. See the designs below for complementary patterns for drawers, rails and corners. Approximate carving time is 5 minutes.

DESCRIPTION	CARVING DIMENSIONS mm	No. OF TEMPLATES	ORDER NO.
Classical cabinet door - A	440 x 185	2	<b>RCS-302</b>
Florentine cabinet door - B	415 x 170	2	<b>RCS-304</b>
Cascade cabinet door - C	365 x 210	1	<b>RCS-305</b>
Roma cabinet door - D	375 x 200	1	<b>RCS-306</b>
Fleur-de-Lys door - E	250 x 180	4	<b>RCS-805</b>
Spanish fan template - F	380 x 200	2	<b>RCS-806</b>
Cabinet door holding frame			<b>RCS-003</b>





**TIP:** many carvings, like the Florentine rail, are enhanced with the additional of a rosette.



## Panel & Rail Carvings

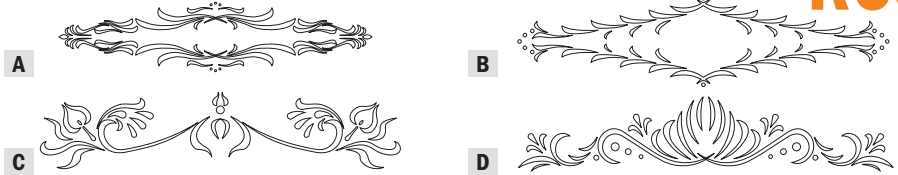

With a long, horizontal shape, these designs are perfect for door rails, headboards, cabinet face frames and valences. Approximate carving time is 4 minutes.

DESCRIPTION	CARVING DIMENSIONS mm	NO. OF TEMPLATES	ORDER NO.
Classical Rail - A	550 x 120	2	<b>RCS-402</b>
Florentine Rail - B	550 x 130	2	<b>RCS-404</b>
Cascade Rail - C	530 x 110	3	<b>RCS-405</b>
Folklore Rail - D	550 x 110	3	<b>RCS-406</b>
Rail Holding Frame			<b>RCS-004</b>

## Drawer & Furniture Carvings

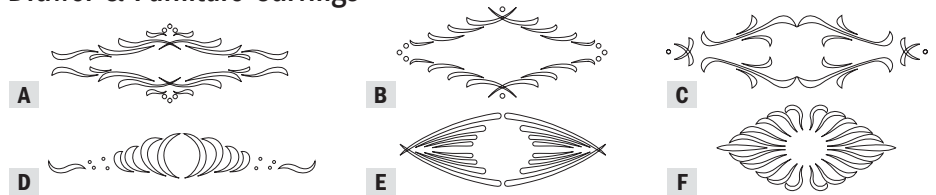

Originally intended for drawer fronts, these designs are great for lots of other projects: small doors, side panels of cabinets, furniture and more. For door and drawer combinations, match the style of the door designs above. Approximate carving time is 4 minutes.

DESCRIPTION	CARVING DIMENSIONS mm	NO. OF TEMPLATES	ORDER NO.
Classical Drawer - A	210 x 70	2	<b>RCS-502</b>
Florentine Drawer - B	195 x 85	2	<b>RCS-504</b>
Cascade Drawer - C	250 x 65	1	<b>RCS-505</b>
Folklore Drawer - D	250 x 40	2	<b>RCS-506</b>
Roma Drawer - E	190 x 65	2	<b>RCS-507</b>
Blaze Drawer - F	250 x 110	2	<b>RCS-510</b>
Drawer Holding Frame			<b>RCS-005</b>



## Corner & Small Decoration Carving Designs



DESCRIPTION	CARVING DIMENSIONS mm	NO. OF TEMPLATES	ORDER NO.
Classical "A"	155 x 40	3	<b>RCS-602</b>
Florentine "B"	120 x 30	3	<b>RCS-604</b>
Cascade "C"	190 x 40	3	<b>RCS-605</b>
Folklore "D"	150 x 45	3	<b>RCS-606</b>
Corner Holding Frame			<b>RCS-006</b>

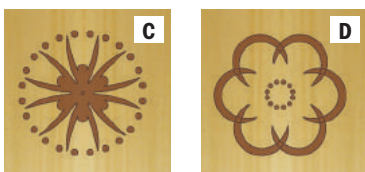
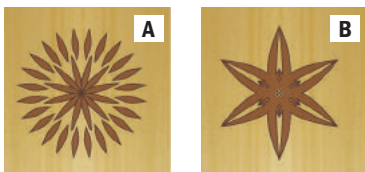

## Rosette Carvings

You get two templates for the price of one with these designs! Each item includes templates for two sizes of rosette. Use with the rosette frame sold above, or use the large rosettes with the cabinet door frame or small rosettes with rail frame.

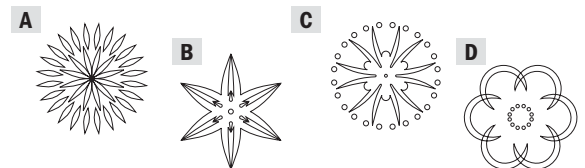

DESCRIPTION	CARVING DIMENSIONS mm	NO. OF TEMPLATES	ORDER NO.
Rosette #1 & #5 - A	85 & 68	2 & 2	<b>RCS-701</b>
Rosette #2 & #6 - B	88 & 70	1 & 1	<b>RCS-702</b>
Rosette #3 & #7 - C	82 & 65	1 & 1	<b>RCS-703</b>
Rosette #4 & #8 - D	79 & 62	1 & 1	<b>RCS-704</b>
Rosette Holding Frame			<b>RCS-007</b>

### Southwestern Carving Designs

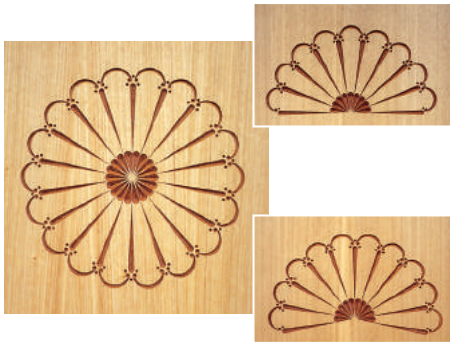

These popular Southwestern designs are actually several shapes in one. Both sizes can be routed as circular carvings, or use only portions of the template to suit your project.

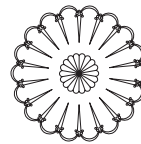

Rout the complete spanish fan design or make partial rosettes

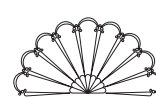

DESCRIPTION	CARVING DIMENSIONS mm	NO. OF TEMPLATES	ORDER NO.
Large Spanish Fan	400	1	<b>RCS-801</b>
Small Spanish Fan	200	1	<b>RCS-802</b>
Rosette Holding Frame			<b>RCS-007</b>

### Just for fun: Designs For every animal lover!



Your imagination will be your guide on these neat designs. Furniture or decorations for the kids, paneling for the den or rec room, a gift for the sportsman.

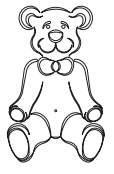
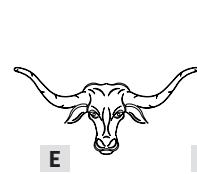

DESCRIPTION	CARVING DIMENSIONS mm	NO. OF TEMPLATES	ORDER NO.
Dolphin - A	200 x 290	4	<b>RCS-803</b>
Eagle - B	178 x 298	4	<b>RCS-804</b>
Deer - C	394 x 190	4	<b>RCS-901</b>
Horse - D	445 x 203	3	<b>RCS-902</b>
Longhorn - E	419 x 194	4	<b>RCS-904</b>
Teddy bear - F	394 x 203	3	<b>RCS-906</b>
Cabinet Door Holding Frame			<b>RCS-003</b>

### Organizer

#### 100 bits at your fingertips

When you constantly work on projects, you always need your most used bits right within reach and safely organized.

CMT gives you the perfect solution for keeping them all in sight, thanks to the 100 piece organizer.

This conveniently holds any size router or drill bit by using CMT's interchangeable bushings to fit all CMT shank diameters. See options listed below.

# 03.51



DESCRIPTION	ORDER NO.
Bit Organizer (without bushings)	<b>03.51.0106</b>
Interchangeable Bushings for Ø6mm shank (20-Pcs.)	<b>03.51.0046A</b>
Interchangeable Bushings for Ø6,35mm shank (20-Pcs.)	<b>03.51.0047A</b>
Interchangeable Bushings for Ø8mm shank (20-Pcs.)	<b>03.51.0048A</b>
Interchangeable Bushings for Ø9,5mm shank (20-Pcs.)	<b>03.51.0057A</b>
Interchangeable Bushings for Ø10mm shank (20-Pcs.)	<b>03.51.0058A</b>
Interchangeable Bushings for Ø12mm shank (20-Pcs.)	<b>03.51.0059A</b>
Interchangeable Bushings for Ø12,7mm shank (20-Pcs.)	<b>03.51.0049A</b>



# Formula 2050: Blade & Bit Cleaner



Finally a safe, environmentally-friendly cleaner that is more effective than all those hazardous chemicals used for cleaning cutting tools.

998

Saw shops know how to get the most out of cutting tools. They know that the pitch and resin left by wood on tools greatly shortens the life of carbide. Therefore we asked many blade sharpeners to test Formula 2050 and they rated it as an excellent product. Most blade and bit cleaning products work with dissolving action, but it takes some power and nasty chemicals to dissolve wood residues and adhesives. CMT's non-toxic and safe Formula 2050 penetrates the microscopic cracks in the resin and attacks the bond between carbide or steel surfaces and the resin itself. Formula 2050 keeps your tools clean and helps you increase the life span between sharpening and replacement.



Prolonged use of this product may cause damage to special coating treatments applied to aluminum tool surfaces. Use with caution.

DESCRIPTION		ORDER NO.
0,5 lt. spray bottle	8	998.001.01
5 lt. plastic jug	5	998.001.03

★★★★★

*This product received a five-star performance rating from "Wood® Magazine"*

Shipping terms and minimum orders must be arranged with the sales department.

- Removes pitch, resin and adhesive residue from all woodworking cutting tools (saw blades, router bits, drill bits, shaper cutters, planer blades, etc.).
- Completely non-toxic, non-flammable and certified biodegradable. Formula 2050 is a safe, earth-friendly product.
- Do not rinse after cleaning. Formula 2050 provides protection from rust and corrosion. Keeps your table saw top rust free too!
- Can be applied by spray bottle or used in ultrasonic cleaners and dip tanks.

# Lubricant for Wood, Neutralizes Resin

- Neutralizes resin, preventing it from being stuck on chips and sawdust.
- Cleans knobs, barbell handles, etc.
- Anti-corrosion action on woodworking machine table.
- Excellent against humidity.

998

DESCRIPTION		ORDER NO.
1 lt. spray bottle	12	998.002.01
5 lt. plastic jug	2	998.002.03

Shipping terms and minimum orders must be arranged with the sales department.



Watch the video on **YouTube**



998.002.01



998.002.03



**INSTRUCTION:** spray or apply the product on the desired parts of your woodworking machine. You will obtain a uniform layer on its surface that will aid in the sliding of your workpiece.



## Flexible Templates for Curved & Arched Routing

The CMT flexible template is easy to screw on any kind of wooden panels, MDF or chipboard for creating forms, arcs and curved elements easily and rapidly. In order to fix your template you can use countersunk screws, which are widely available on the market. The CMT template is made of a highly-resistant flexible plastic, which can be tied in knots without any risk of ruining or reducing flexibility.

Screw your template to the edge of the panel and follow its shape and rout the border on the guide ring. The template is suitable for manual feed on routers, router tables and spindle moulders. Rout easily, safely and accurately to make multiple forms such as arcs, curved elements and cut-out forms. Mark the edge of your form precisely and screw it onto a previously-placed panel from underneath.

If you rout with a guide ring mounted onto your spindle moulder, keep your hands a safe distance behind the template. Two different profiles in three lengths are available. Please notice that the smallest profile features a short radius, whereas the larger profile features a larger opening in case of flat and long curves.

**TECHNICAL SPECIFICATIONS:**

- Special plastic without any plasticizer.
- Made in Germany.
- Lasts more than 10 years!

DESCRIPTION	L mm	ORDER NO.
Flexible template for routing 18x18mm	1000	<b>TMP-1000</b>
Flexible template for routing 12x12mm	1200	<b>TMP-1200</b>
Flexible template for routing 18x18mm	2000	<b>TMP-2000</b>

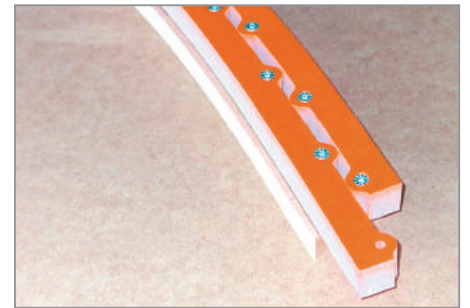
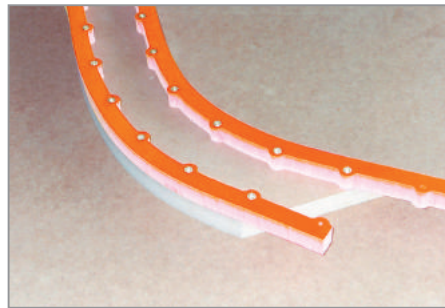
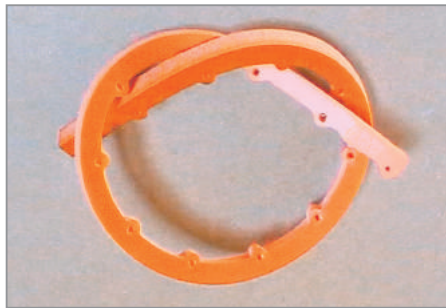
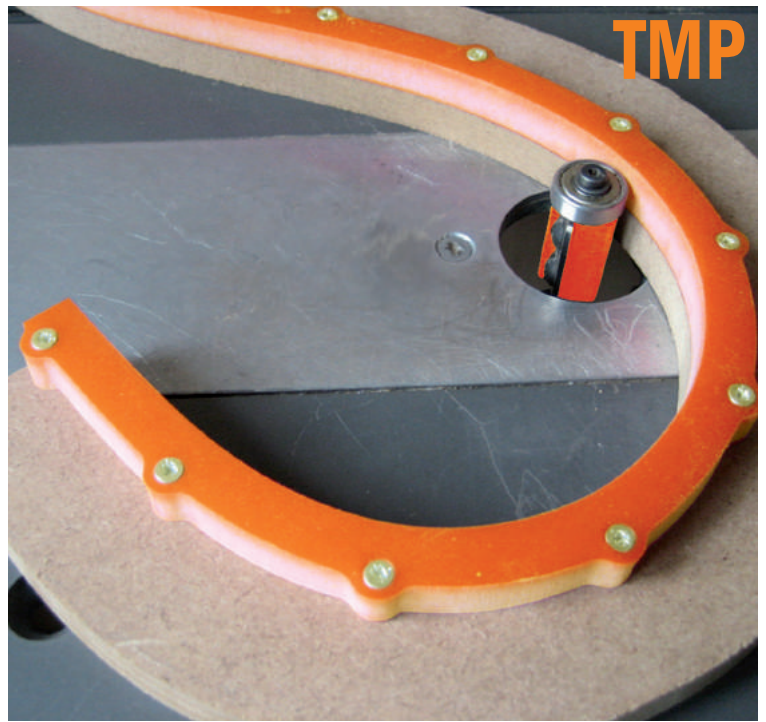

## 12 Corner Radius Router Template Set from 3mm to 25mm

Our useful 3-piece corner radius template set includes 8mm thick acrylic templates that will allow you to make 12 different radii (4 per template) by using a flush trim or a pattern bit (sold separately). Included with the templates you will also find 4 alignment pins and 4 wood screws. Use the pins to align the template onto your workpiece, then use the four wood screws provided to secure it. Remove the alignment pins and use the bit to cut the corner of your workpiece to the same radius as the template.

RADIUS	
mm	inches
3	1/8"
5	3/16"
6	1/4"
8	5/16"
10	3/8"
11	7/16"
12	1/2"
14	9/16"
16	5/8"
19	3/4"
22	7/8"
25	1"



DESCRIPTION	ORDER NO.
12 Corner Radius Router Template	<b>TMP-R12</b>
<b>Set contains:</b>	
12 Different Radii (3 templates)	
4 Alignment Pins	
4 Wood Screw	

## Laminate/Veneered-Panel Cutter

A very useful hand tool for clean, splinter-free cuts on laminates and veneered with no waste. Place your material into the fence provided and have the cutter run along the edge of the panel. The two opposing steel-made circular cutting blades mounted on roller bearings will trace the cutting line. Use the micrometer knob on the top of the tool to set the cutting thickness, or adjust the strip width by using the metric/inch scale provided. Loosen the lock knob on the scale, move the metal bracket which holds the fence and tighten the lock knob again on the desired cutting width.

**TECHNICAL FEATURES:**

- Cutting width: 12~110mm (15/32" ~ 4-21/64")
- Cutting depth: 0~2mm (0 ~ 5/64")
- Weight: 1.2 kg (2.65 lbs)



**DET-003**

DESCRIPTION	ORDER NO.
Laminate/Veneered-Panel Cutter	DET-003

## Edge Banding Iron

Apply pre-glued edge banding easily and accurately. The iron non-stick surface allows smooth and easy application. The thermostatically controlled short preheat time gets you working quicker. Includes heat resistant metal base to place iron when not in use.

- Includes thermostatic heat control.
- Non-stick coating.
- Specially shaped shoe with rounded edges.
- Metal stand.
- 154cm (5-1/2') power cord, 230V.



**DET-004**

**TECHNICAL FEATURES:**

- Voltage: 230V.
- Electric current: 2.5A.
- Low temperature: 70° ±10° C.
- High temperature: 150° ±10° C.

DESCRIPTION	ORDER NO.
Edge Banding Iron	DET-004

## Edge Banding End Trimmer

An indispensable tool for easy and safe end trimming after edge banding. Position the tool on the banding, press down on the handle to operate the blade in a shearing action. The cutting knives are interchangeable, so when the cutting knife becomes dull, you can simply replace it with the anvil knife for a double lifetime. For cutting banding up to 0,5mm thick with a maximum cutting width of 54mm.

This tool can also be paired up with our double edge trimmer DET-001. We recommend using our edge banding end trimmer DET-002 before using our double-edge trimmer DET-001.

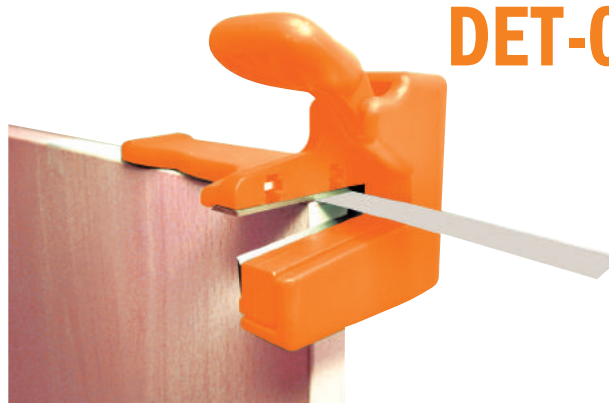

**DET-002**

DESCRIPTION	ORDER NO.
Edge Banding End Trimmer	DET-002

**Spare parts**     **DET-002K** 2-Pcs replacement blade set 55x13x1,5mm

## Double-Edge Trimmer

Attach this trimmer to your workpiece, press both ends against the board for a cutting range between 13mm (1/2") and 25mm (1"), move the trimmer in the correct direction indicated by the arrow. This will cut on both sides easily. The first cutter will cut straight, the second one can be adjusted for a tapering cut. Both cutters are made from high-quality hardened steel and can be easily replaced when worn out.

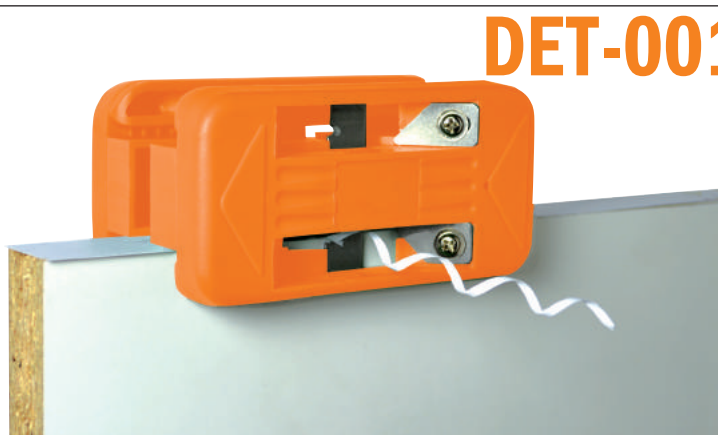

**DET-001**

DESCRIPTION	ORDER NO.
Double-Edge Trimmer	DET-001

**Spare parts**     **DET-001K** Spare knives for double-edge trimmer



# Digital Height Gauge

# DHG-001



- Precise measurements for router bits, saw blades, band saw blades, cutter heads, drill bits, holes depth.
- Measuring ruler with Metric/Imperial scale and locking screw.
- Horizontal & vertical measuring.
- Digital easy-to-read display.
- Self-standing with magnets, for setting cutting depth on router tables and low profiles for backfence adjustment.
- Instruction manual.



**TECHNICAL DETAILS:**

- Measuring range: Scale: 0~80mm (0~3"); Needle: 0~50mm (0~2")
- Wide opening: 60mm (2.5")
- Resolution: 0.05mm (0.002")
- Accuracy: ±0.1mm (±0.004")
- Battery: **Included**
- Battery Type: CR2032-3V; Lithium Button Cell



Place your gauge on a flat surface and set to "0" on the display.

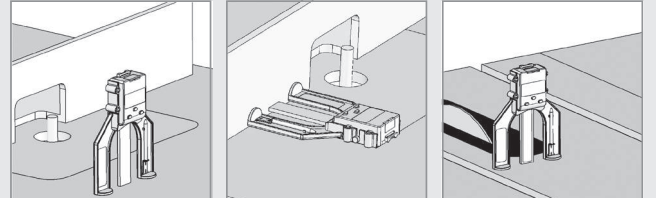

Position your gauge on the desired position.

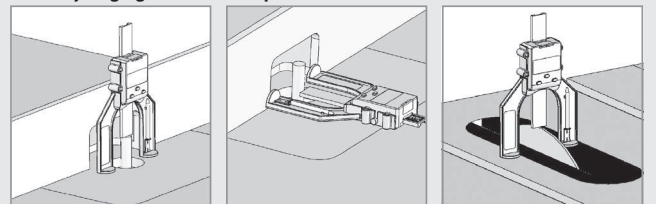

Insert needle and set to "0".

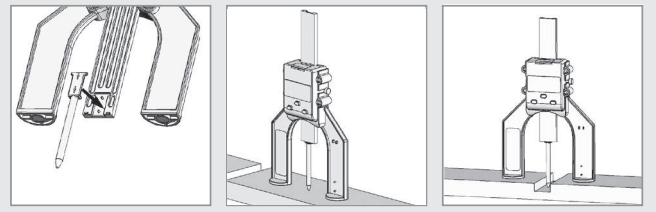

DESCRIPTION		ORDER NO.
Digital Height Gauge	10	DHG-001

# Digital Moisture Meter

# DMM-001



Ideal for use in woodworking, building construction and agriculture industries. The DMM-001 is also an invaluable tool in the restoration field. Ideal for locating moisture in carpets and sub-flooring. Ultra-sensitive Digital Moisture Meter easily detects hidden leaks in wood, concrete, plaster and carpet. Providing accurate moisture level readings make this tool great for new home inspections, locating roof leaks or even selecting dry lumber at the yard. Display will show the moisture content in Percent Moisture Content directly.

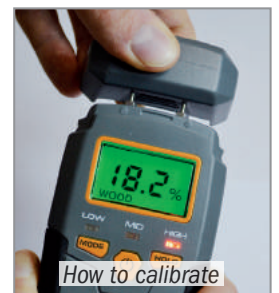

**TECHNICAL DETAILS:**

- Moisture measuring range: 5~50% (in wood); 1.5~33% (in building material)
- Measuring accuracy: ±2%
- Backlight shut off: In about 15 seconds
- Auto power off: After 3 minutes idle
- Battery: **Included**
- Battery Type: 9V Battery Block (6F22 or 6LR6); Alkaline <7V
- Low battery indicator: <25mA
- Working current: 32°F~122°F
- Working temperature: <90%RH non-condensing
- Working humidity: -4°F~140°F ≤85% (without battery)
- Storage: -
- Dimensions: 145 x 65 x 25mm (5-11/16" x 2-9/16" x 1")
- Weight: About 3oz (without battery)

- Measures moisture content by detecting a material's electrical resistivity using two pins.
- Measurement output is displayed on a practical LCD screen.
- Instruction manual.



DESCRIPTION		ORDER NO.
Digital Moisture Meter	5	DMM-001

Spare parts DMM-001/1 Set 2 Pin for DMM-001



## Digital Angle Gauge

# DAG-001



The digital angle gauge is a mini waterproof digital protractor that provides digital readings between  $\pm 90^\circ \times 4$  with a resolution of  $0.1^\circ$  and features auto shut off after 5 minutes. It is small enough to be carried around in your pocket and the LED screen is easy to read. It incorporates magnets in the base for adhesion to any ferrous surface to accurately measure mitre and bevel angles on mitre saws, saw benches, etc.

- Accurately sets saw blade bevel angle, works great for miter saws and table saws.
- Automatic LCD backlight
- Large display for easy digital reading
- Measurements in absolute or relative mode
- Angles displayed in degrees
- Automatic digit inversion for overhead measurements
- Set to ZERO
- Magnetic base
- Case included
- Instruction manual

**TECHNICAL DETAILS:**

- Range:  $\pm 90^\circ \times 4$
- Resolution:  $0.1^\circ$
- Battery: **Included**
- Battery Type: AAA-1.5V; Alkaline
- Dimensions: 60 x 60 x 28mm (2-3/8" x 2-3/8" x 1-1/8")

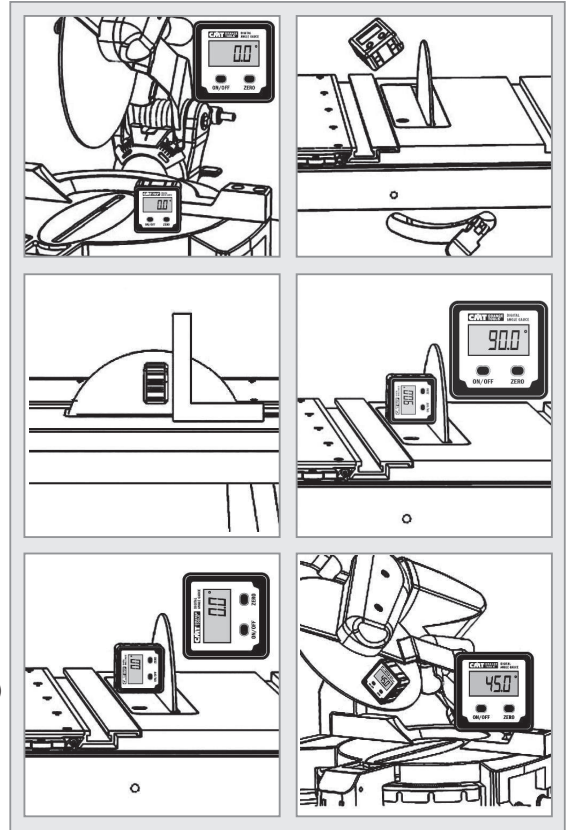

Watch the video on **YouTube**

DESCRIPTION	ORDER NO.
Digital Angle Gauge	<b>DAG-001</b>

## Digital Angle Finder

# DAF-001



This digital angle finder is a multi-functional tool for many measuring applications. Easy to operate, the base unit carries the electronics featuring clear detailed LCD display, a pair of levelling vials and a pivoting measuring arm. When the arm is extended, the angle created with the base is indicated clearly on digital read-out to the nearest  $0.05^\circ$ . The measuring range is  $0 - 360^\circ$ . The vials allow both vertical and horizontal variations to be accurately measured. Other features include a lock function to prevent the last measurement being lost, a low battery indicator and automatic shut off function. Robust yet lightweight, this tool is very versatile.

DESCRIPTION	ORDER NO.
Digital Angle Finder	<b>DAF-001</b>



Watch the video on **YouTube**



- Easy and simple to use.
- Calculates angles in seconds.
- Large detailed LCD display.
- Robust, lightweight aluminium construction.
- Instruction manual.

**TECHNICAL DETAILS:**

- Range:  $0 - 360^\circ$
- Resolution:  $0.05^\circ$
- Battery: **Included**
- Battery Type: CR2032-3V; Lithium Button Cell
- Dimensions: 260 x 50 x 25mm (10-1/4" x 2" x 1")

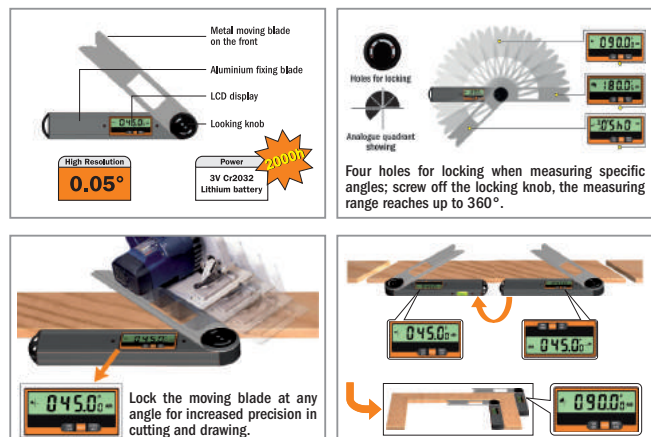

## For professional, industrial and home users

**FAST:** real quality diamond, the hardest known material, reduces the sharpening process.

**EASY:** stoke the blade across the surface with little pressure.

**DURABLE:** we use natural diamonds for long-lasting performance.

**VERSATILE:** for sharpening any hard material, steel, glass, ceramic, tungsten carbide, etc.



### FOR SHARPENING, HONING AND LAPPING

- axes
- bayonets
- broadheads
- cable cutters
- carbide cutters
- chainsaws
- chisels
- climbing equipment
- engraving tools
- farm and garden tools
- fish hooks
- Forstner bits
- knives
- lapidary tools
- lawn mower blades
- masonry drills
- moulds and dies
- plane blades
- planer /jointer knives
- pruners

- ring tool
- router bits
- saw blades
- scissors
- shears
- ski and snowboard edges
- small contact area and pointed tools
- speed and hockey skates
- woodcarving scrapers
- woodturning tools

### FOR ABRADING HARD MATERIALS

- ceramic
- composites
- fiberglass
- glass
- stainless steel
- stone
- titanium
- tool steel
- tungsten carbide

### FOR FLATTENING

- chisel backs
- engine heads
- machine bolsters and ways

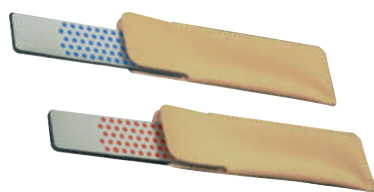

### Universal diamond whetstone in leather sheaths

DIMENSIONS mm	GRAIN	COLOUR	ORDER NO.
115 x 25 x 3	D15 extrafine	green	DSS-115E
115 x 25 x 3	D25 fine	red	DSS-115F
115 x 25 x 3	D46 coarse	blue	DSS-115M
115 x 25 x 3	D76 extracoarse	black	DSS-115G



### Diamond whetstone file

DIMENSIONS mm	GRAIN	COLOUR	ORDER NO.
100 Ø4,8	D54 coarse	blue	DSS-048M

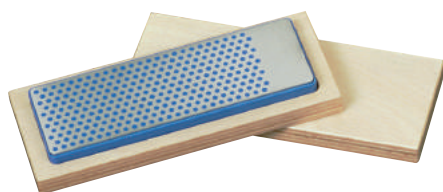

### Universal diamond whetstones in hardwood case

DIMENSIONS mm	GRAIN	COLOUR	ORDER NO.
150 x 52 x 16	D15 extrafine	green	DSS-150E
150 x 52 x 16	D25 fine	red	DSS-150F
150 x 52 x 16	D46 coarse	blue	DSS-150M
150 x 52 x 16	D76 extracoarse	black	DSS-150G

### A unique production process to guarantee long tool life

A perforated steel plate is moulded onto a strong plastic base by applying high pressure. The steel is then covered with natural diamonds embedded into a nickel plate. The pattern and diamond coating ensures fast sharpening, whereas the plastic indents hold the lubricating water and disperse the fine dust emitted by the diamonds during sharpening.

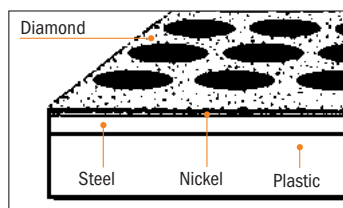

### The diamond whetstones are available in four meshes for multiple purposes:

#### D15 EXTRAFINE/GREEN (9 microns, 1200 mesh)

To refine and polish sharp edges to razor sharp perfection. If you are new to sharpening or need your knife or tool edges as sharp as possible, this grain type but if this suffice, then this is what you are looking for.

#### D25 FINE/RED (25 microns, 600 mesh)

To restore any slightly dull knife or tool edges to perfect sharpness. Many customers consider the fine grit grain to be suitable to satisfy any working need. Professional chefs and gourmet cooks prefer using this grit grain too. This product is perfect for the edge refinement process before micro-refinement and polishing.

#### D46 COARSE/BLUE (45 microns, 325 mesh)

To quickly restore dull edges. For workers who require faster cutting action and less edge refinement often use this grit grain.

#### D76 EXTRA-COARSE/BLACK (60 microns, 220 mesh)

Recommended for aggressive removal of metal on damaged tools or for heavy-duty outdoor tools such as axes and lawn mower blades. Also, this grit grain is commonly used as a first step for flattening the back of chisel and plane irons or for rapid stock removal from chipped or badly damaged edges.

## Instructions

Use water for lubrication, after use, rinse and store dry.

1. Keep your knife with cutting edge away from you.

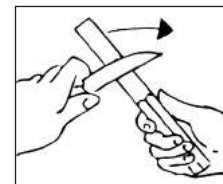

2. Apply some water to the stone surface. Hold blade 20° to diamond surface.

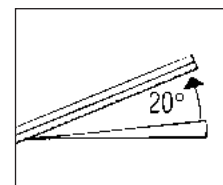

3. With little pressure and in long strokes push the blade across surface. From edge heel to edge tip, alternately on both sides. For pointed tools. Use the unperforated diamond area.

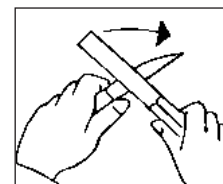



# Bowl & Tray System

## BTS-002

CMT System BTS-002 provides a fun and easy way for you to make divided bowls and trays in your shop. No lathe? No problem. This bowl making technique uses a router and CMT's unique bowl and tray router bit. The resulting bowls and trays are beautiful. This kit also provides an excellent way to use up scrap wood. Glue pieces together, butcher block style, to make a beautiful pattern of colors and species.

The templates will withstand a lifetime of use and can be used to make a variety of bowl or tray styles. The collet extension, used to make extra deep bowls, is also useful whenever your general woodworking requires extra deep cuts.



**TMP-012**  
MDF Template



**TMP-011**  
MDF Template



DESCRIPTION	ORDER NO. S=Ø12mm
Bowl & Tray System	<b>BTS-002</b>
<i>The kit includes</i>	
Router Bit	951.502.11B
Router Collet Extension	796.002.00
MDF Template nr. 1	TMP-011
MDF Template nr. 2	TMP-012
Instruction manual	



Join us on our  
**YouTube**



Trace the templates onto the bowl blank.



Rough out the interior using a drill press and a 50,8mm Forstner bit.



Rout the interior to final shape using the bowl and tray router bit and collet extension.



Bandsaw the exterior to final shape.

**Optional**



**TMP-101**  
MDF Template  
400x400mm.



**TMP-103**  
MDF Template  
400x400mm.



**TMP-105**  
MDF Template  
330x300mm.



## Folding Ruler

- Fiberglass material, water & scratch resistant.
- Impact resistant, tough yet flexible.
- No rust.
- Guaranteed professional quality.
- Merchending display with 12 rulers.



**FR2M**

DESCRIPTION		ORDER NO.
Folding Ruler	12	FR2M

## Carpenter Pencil

An easy-grip shape and larger rectangular surface area means this pencil won't roll away or slip from your hands. The non-round core makes highly legible thick or thin lines. Perfect for tracing high precision markings on virtually any surface and easy to erase.

Strong lead center withstands the stress of rough handling as well as the rigours and extreme conditions of the construction environment.



**PCL-1**

DESCRIPTION		ORDER NO.
Carpenter Pencil	50	PCL-1

## CMT Professional Tool Bag

- Top zipped design and wide opening for accessing tools easily.
- Sturdy material and hard rubber bottom are resistant to rough handling and protects the contents from hard falls.
- 6 interior pockets, 12 exterior pockets.
- Ideal for storing and transporting hand tools as well as other medium sized items & accessories.

Material: Polyester 600D with 3mm EPE foam  
Dimensions: 400x200x250mm



**BAG-001**



5 rubber studs at bottom



DESCRIPTION		ORDER NO.
CMT Professional Tool Bag	12	BAG-001

# DISPLAY CABINETS

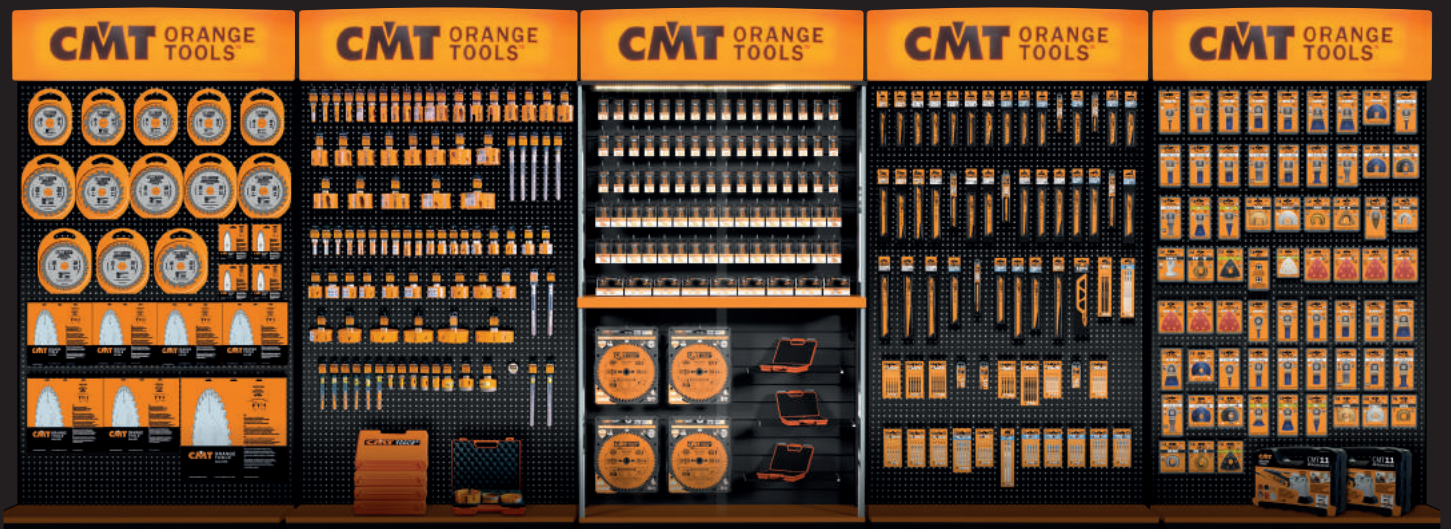

PRODUCTS	PAGE
Display Cabinets for Saw Blades	384
Display Cabinets for Sabre & Jig Saw Blades	385
Display Cabinets for Multi-Cutters	386
Display Cabinets for Router Bits	387
Display Cabinets for Router Bits & Forstner Bits	388
Display Cabinets for Hole Saws	389
Display Cabinets for Drill & Boring Bits	390
Multi Tools Mini Counter Display	391





## Display Cabinets for Saw Blades

A sturdy steel saw blade display cabinet equipped with a backlight to place anywhere in your store. Hang and display a variety of different saw blades. Contact your CMT representative to seek advice on the most effective sawblade display composition for your needs. Tools not included.

**03.00.0038**

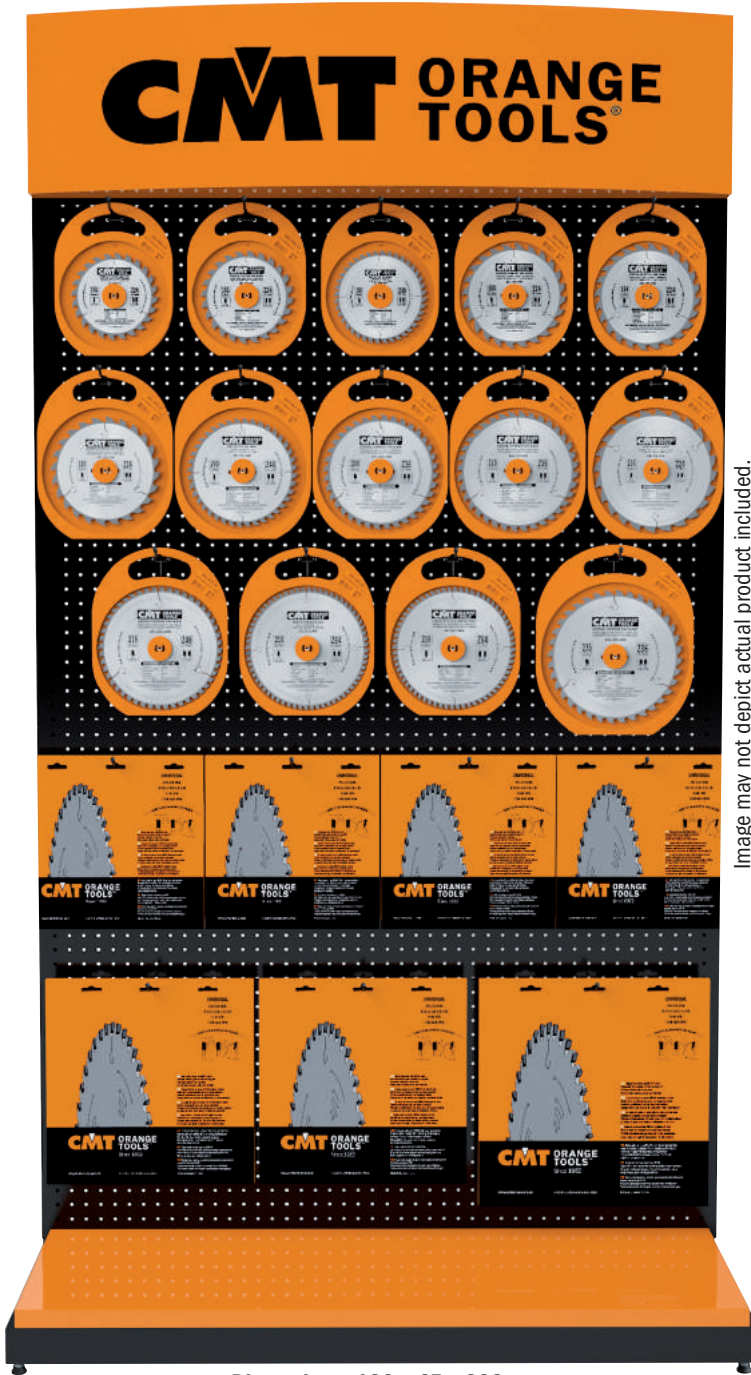

Dimensions: 120 x 45 x 223cm.

Image may not depict actual product included.

**03.00.0030**

We also offer a practical wire counter display for saw blades up to Ø350mm.



Dimensions: 51 x 49 x 27cm.

**DISPLAYS THAT SELL!**

Suitable for all blades types



**03.53.0011-X24**  
(150mm.)



**03.53.0012-X24**  
(50mm.)

DESCRIPTION	ORDER NO.
Wire counter display only ( <i>empty</i> )	03.00.0030
Display cabinet with backlight (220V) for saw blades ( <i>empty</i> ) hooks not included, order separately	03.00.0038
Hooks 50mm. (24-pc pack)	03.53.0012-X24
Hooks 150mm. (24-pc pack)	03.53.0011-X24
Lighted header sign CMT ORANGE 220V ( <i>spare parts</i> )	03.54.0084
220V LED wand for sign display cabinet ( <i>spare parts</i> )	03.54.0097



# Display Cabinets for Sabre & Jig Saw Blades



A sturdy steel sabre and jig saw blade display cabinet equipped with a backlight to place anywhere in your store. You can hang and display a variety of different blades. Contact your CMT representative to seek advice on the most suitable blade display composition for your needs. Tools not included.

## IMBALLO143



**Counter cardboard display for jig saw blades**  
CMT's end cap cardboard display for jig saw blades takes advantage of the existing space in your store and is designed for being placed on a counter, existing shelves or inside CMT's display cabinets. Suitable for stocking up to 12 different jig saw blade types, 10 packs each, 120 packs in total. The end cap cardboard display helps increase product visibility and sell more!

**DISPLAYS THAT SELL!**

## 03.00.0038

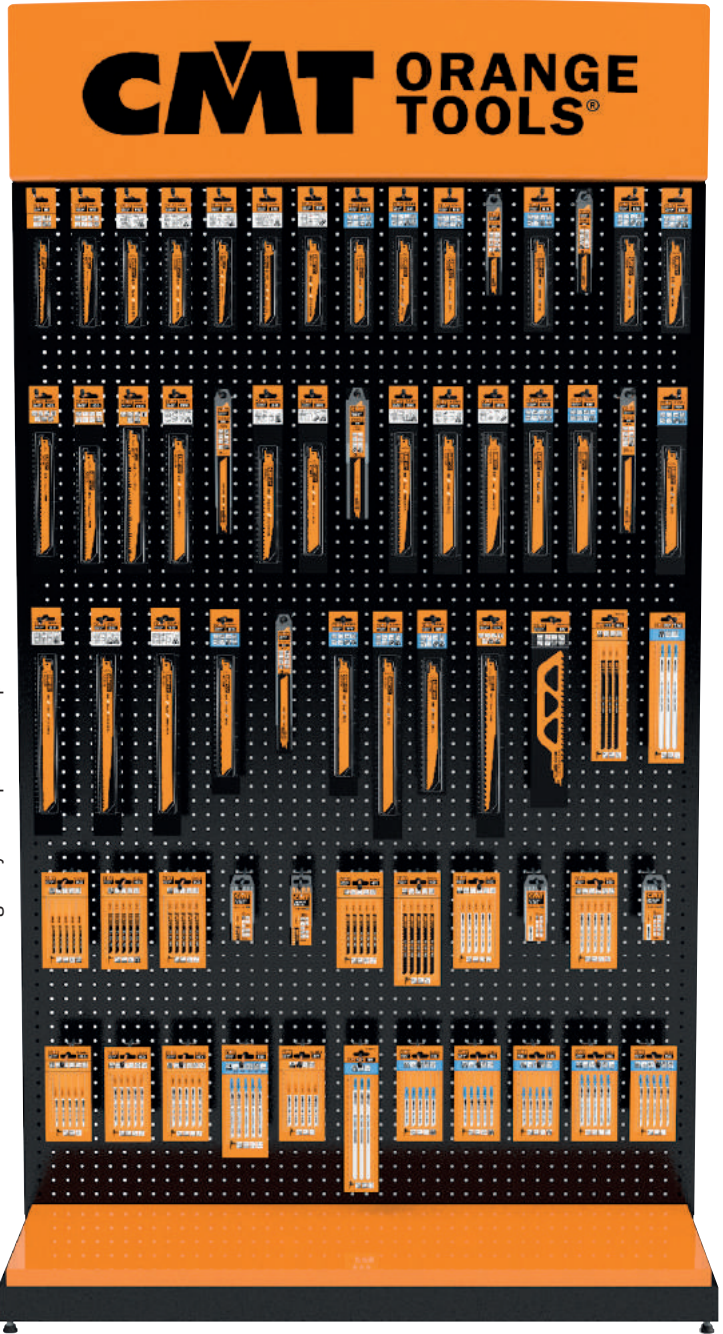
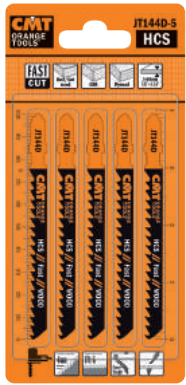
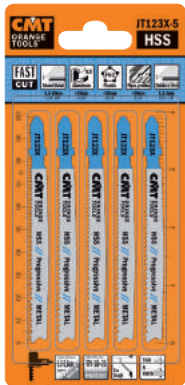

Image may not depict actual product included.

Dimensions: 120 x 45 x 223cm.



5-PIECE MASTERPACK



25-PIECE MASTERPACK



5-PIECE MASTERPACK



20-PIECE MASTERPACK



03.53.0020-X12  
(50mm, for JS)



03.53.0012-X24  
(50mm)



03.53.0011-X24  
(150mm)

DESCRIPTION	ORDER NO.
Counter display only ( <i>empty</i> )	IMBALLO143
Display cabinet with backlight (220V) for sabre and jig saw blades ( <i>empty</i> ) hooks not included, order separately	03.00.0038
Hooks 50mm. (24-pc pack)	03.53.0012-X24
Hooks 50mm. for JS (12-pc pack)	03.53.0020-X12
Hooks 150mm. (24-pc pack)	03.53.0011-X24
Lighted header sign CMT ORANGE 220V ( <i>spare parts</i> )	03.54.0084
220V LED wand for sign display cabinet ( <i>spare parts</i> )	03.54.0097



# Display Cabinet for Multi-Cutters

A sturdy steel multi-cutter display cabinet featuring an attractive backlight to place anywhere in your store. You can hang and display a variety of different cutters. Contact your CMT representative to seek advice on the most effective cutter display composition for your needs. Tools not included.

**03.00.0038**



Image may not depict actual product included.



Dimensions: 120 x 45 x 223cm.

**1-PIECE CLAMSHELL  
5-PIECE MASTERPACK**



**03.53.0011-X24**  
(150mm.)



**03.53.0012-X24**  
(50mm.)

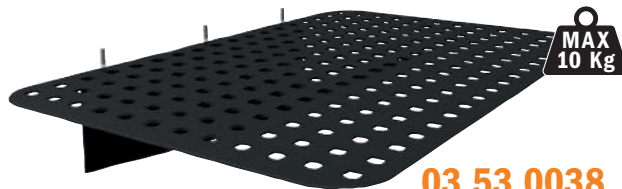

**03.53.0038**  
Minimum order 2-pieces or multiple

**DISPLAYS  
THAT SELL!**

DESCRIPTION	ORDER NO.
Display cabinet with backlight (220V) for multi-cutters ( <b>empty</b> ) hooks not included, order separately	<b>03.00.0038</b>
Hooks 50mm. (24-pc pack)	<b>03.53.0012-X24</b>
Hooks 150mm. (24-pc pack)	<b>03.53.0011-X24</b>
Lighted header sign CMT ORANGE 220V ( <i>spare parts</i> )	<b>03.54.0084</b>
220V LED wand for sign display cabinet ( <i>spare parts</i> )	<b>03.54.0097</b>

# Display Cabinet for Router Bits



This sturdy structure is hand-crafted from MDF, tempered glass and iron. The cabinet is free-standing and provides 360° visibility thereby allowing you to position the display anywhere in your store. The front is a convenient 2 component assembly. The upper section is designed to display 141 of the best selling router bits from the CMT router bit line as well as 20 corresponding spare parts. The lower compartments can perfectly fit 10 of the most popular wooden box sets or saw blades, if required. Glass doors are secured with key lock.

03.00.0042



Deluxe packaging



03.53.0011-X24  
(150mm.)



03.53.0017

Image may not depict actual product included.



Dimensions: 120 x 45 x 223cm.

DESCRIPTION	ORDER NO.
Display cabinets with: 240 HW router bits (S=Ø6mm), 66 spare parts (saw blades not included, at your choice)	700.300.00L
Display cabinets with: 240 HW router bits (S=Ø8mm), 66 spare parts (saw blades not included, at your choice)	900.300.00L
21 pcs. HW router bits with shank Ø12mm for our display cabinet <b>(optional)</b>	900.021.00
Display cabinet for router bits and cutter heads <b>(empty)</b> / Hooks not included, order separately	03.00.0042
Hooks 150mm. (24-pc pack)	03.53.0011-X24
Toolholder shelf (270x209x1,5mm.) for CMT display cabinet 03.00.0042 for router bit sets	03.53.0017
220V LED wand for sign display cabinet <b>(spare parts)</b>	03.54.0097
Set of 2 220V LED strips for display cabinet <b>(spare parts)</b>	03.54.0089
Set of 2 metal supports (RH-LH) for light header sign <b>(spare parts)</b>	03.53.0109
Lighted header sign CMT ORANGE 220V <b>(spare parts)</b>	03.54.0084



## Display Cabinet for Router Bits & Forstner Bits

A beautiful, well-organized display of router bits in your shop is the best way to encourage customers to buy. CMT has produced this beautiful cabinet to best show off our wide selection of high quality bright orange bits, Forstner bits and boring bits. Made with a sturdy MDF frame and three glass panels, it is the ideal counter-top display. The wooden slat back wall allows for easy bit organization and comes standard with front door lock. Glass door secured with key lock.

**WOOD** MAGAZINE'S CHOICE FOR BEST OVERALL ROUTER BITS  
 Magazine  
**CMT Overall Rating 10!**  
 Top Performing Router Bits

**03.00.0002**

**03.00.0002**



Image may not depict actual product included.

*Suitable for boring and Forstner Bits  
 (at your choice)*



*Deluxe packaging*



*Forstner clamshell*



**03.53.0011-X24**  
 (150mm.)

**DISPLAYS THAT SELL!**

DESCRIPTION	ORDER NO.
Display cabinet with: 76 HW Router bits (S=Ø6mm), 8 Spare parts (2 pcs. each)	700.084.00
Display cabinet with: 76 HW Router bits (S=Ø8mm), 8 Spare parts (2 pcs. each)	900.084.00
Display cabinet for router bits / Forstner bits ( <b>empty</b> ) / Hooks not included, order separately	03.00.0002
Hooks 150mm. (24-pc pack)	03.53.0011-X24

# Display Cabinet for Hole Saws



A sturdy steel hole saw display cabinet complete with a backlight to place anywhere in your store. You can hang a variety of different types of hole saws. Contact your CMT representative to seek advice on the best hole saw display composition for your needs. **Tools not included.**

**NO LIMITS** with the **FASTX4** hole saws you can bore any material of any hardness!

**03.00.0038**

## SERIES 550 TUNGSTEN CARBIDE-TIPPED SERIES 553 TUNGSTEN CARBIDE-TIPPED LONG



**10X**  
LONGER LIFE  
**5X**  
FASTER

## SERIES 551 BI-METAL PLUS 8% COBALT



**2X**  
LONGER LIFE

## SERIES 552 DIAMOND DRY



**10X**  
LONGER LIFE

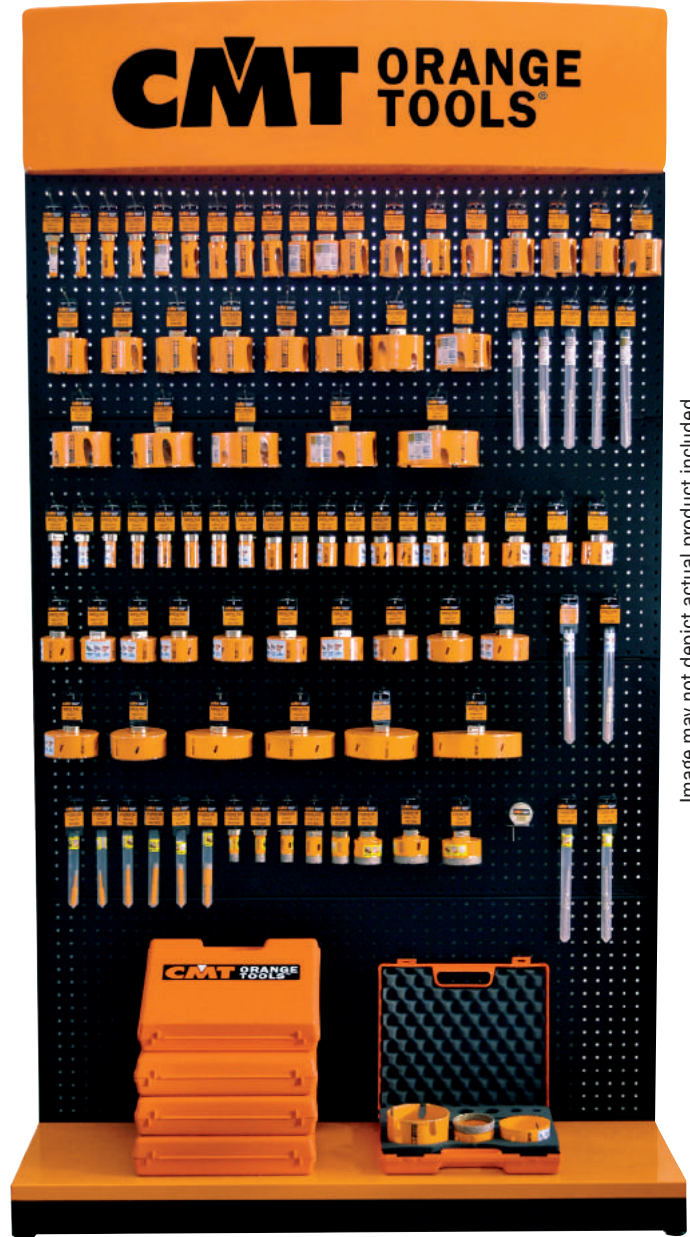
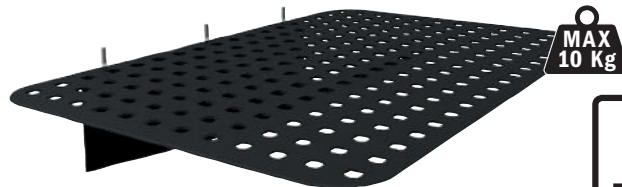

Image may not depict actual product included.

Dimensions: 120 x 45 x 223cm.



**03.53.0038**  
Minimum order 2-pieces or multiple

**DISPLAYS  
THAT SELL!**

DESCRIPTION	ORDER NO.
Display cabinet with backlight (220V) for hole saws ( <b>empty</b> ) hooks not included, order separately	<b>03.00.0038</b>
Hooks 150mm. (24-pc pack)	<b>03.53.0011-X24</b>
Hooks 200mm. (24-pc pack)	<b>03.53.0013-X24</b>
Lighted header sign CMT ORANGE 220V ( <b>spare parts</b> )	<b>03.54.0084</b>
220V LED wand for sign display cabinet ( <b>spare parts</b> )	<b>03.54.0097</b>



## Display Cabinet for Drill & Boring Bits

**03.00.0042**

Start your stock of CMT drill and boring bits now by ordering a convenient display to help you get organized and keep your tools within reach. Contact your CMT representative for information and get the best advice on choosing the right selection of drill bits for your display from our very broad range. Tools not included.

- **Fit Top Selling 120 SKUs.**
- **Fit up to 20 Deep**
- **Secured Glass with Key Lock**

**X TREME BORING BITS**



Image may not depict actual product included.



**03.53.0017** Toolholder steel shelf for drill & boring bits. Fit up to 40 shelves into tower. Fastening screw for bit: 990.010.00  
**Dimensions: 270 x 209 x 1,5mm.**



**Dimensions:**  
120 x 31 x 223cm.

**DISPLAYS THAT SELL!**

DESCRIPTION	ORDER NO.
Display cabinet for drill and boring bits ( <b>empty</b> ) / Toolholder shelf not included, order separately	<b>03.00.0042</b>
Toolholder shelf (270x209x1,5mm.) for CMT display cabinet 03.00.0042 for drill and boring bits (order separately)	<b>03.53.0017</b>
220V lamp for neon sign for display cabinet ( <b>spare parts</b> )	<b>03.54.0087</b>
Set of 2 220V LED strips for display cabinet ( <b>spare parts</b> )	<b>03.54.0089</b>
Set of 2 metal support (RH-LH) for light header sign ( <b>spare parts</b> )	<b>03.53.0109</b>
Lighted header sign CMT ORANGE 220V ( <b>spare parts</b> )	<b>03.54.0084</b>



# Multi Tools Mini Counter Display



## 03.00.0043

This simple yet attractive counter display will increase product visibility and definitely increase your sales. This cabinet supports a great variety of tools like jig saw blades, sabre saw blades, oscillating tools, router bits, Forstner bits, drill bits and hole saws. The best way to attract and encourage customers to buy! A sturdy steel body in our trademark orange colour makes for the ideal eye-catching counter-top display! Tools not included.

## Suitable for all tools type

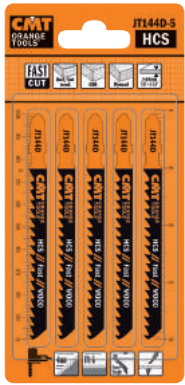

JIG SAW BLADES



SABRE SAW BLADES



OSCILLATING TOOLS



ROUTER BITS



FORSTNER BITS



HOLE SAWS

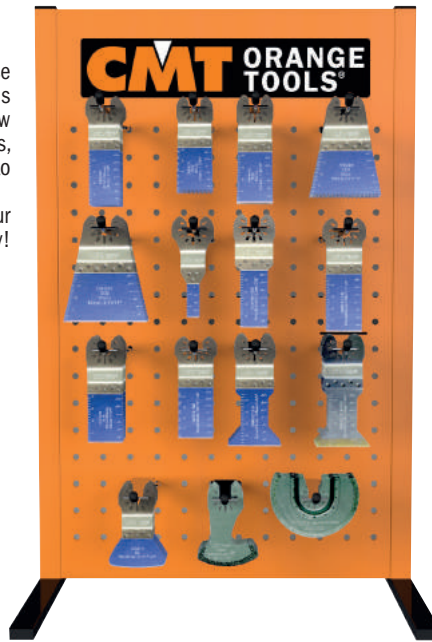

Dimensions: 35 x 56 x 16cm.

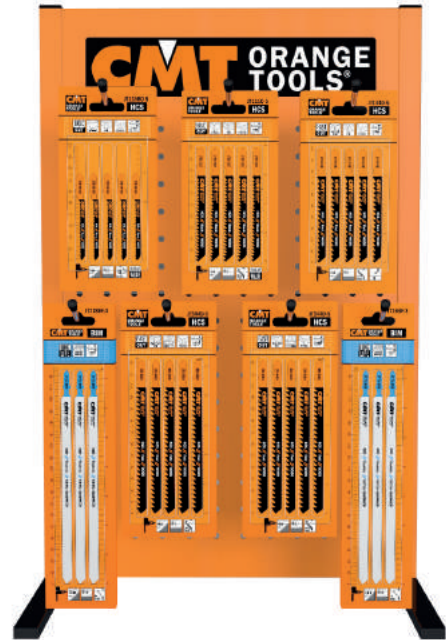
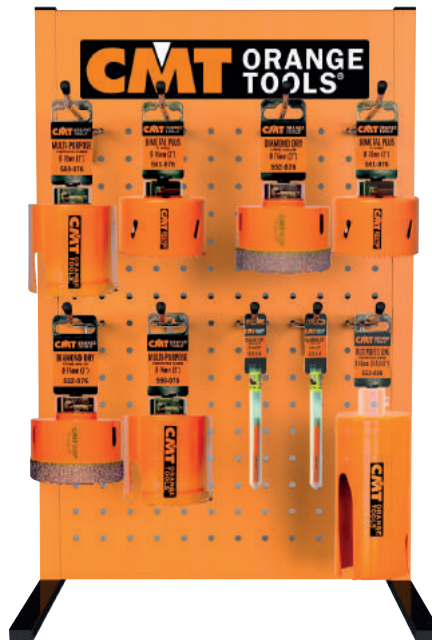
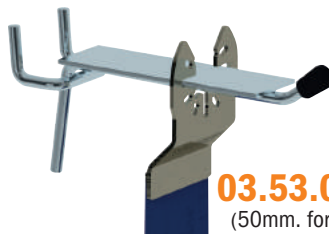

Image may not depict actual product included.



03.53.0012-X24  
(50mm)



03.53.0014-X12  
(50mm. for OMM & OMS)



03.53.0020-X12  
(50mm. for JS)

DESCRIPTION	ORDER NO.
Mini Counter Display ( <b>empty</b> ) Hook not included, order separately	03.00.0043
Hooks 50mm. (24-pc pack)	03.53.0012-X24
Hooks 50mm. for OMM & OMS (12-pc pack)	03.53.0014-X12
Hooks 50mm. for JS (12-pc pack)	03.53.0020-X12

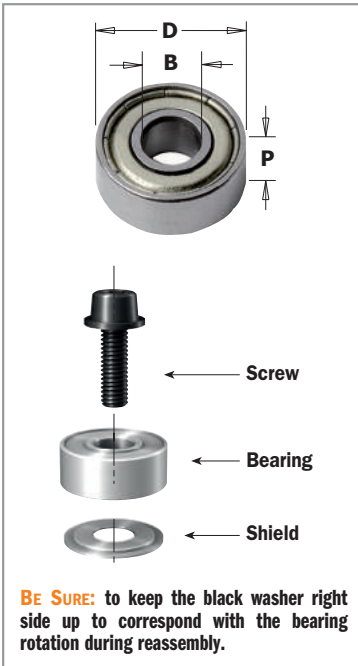

**new**

\* Undersized diameter bearing for use after resharpening. Fits all tools such as flush trims

**791.062.00** Ø9,3 replace bearing 791.002.00 (Ø9,5) after resharpening

**791.063.00** Ø12,5 replace bearing 791.003.00 (Ø12,7) after resharpening

These bearings are supplied in a 10 pc. case. Minimum 10 piece or multiple of 10 piece order.

**Bearings**

	D		B		P		ORDER NO.
	mm	inches	mm	inches	mm		
	6,35	1/4	3,17	1/8	2,8	10	<b>791.035.00</b>
<b>new</b>	9,3		4,76	3/16	3,17	10	<b>791.062.00*</b>
	9,5	3/8	4,76	3/16	3,2	10	<b>791.002.00</b>
<b>new</b>	12,5		4,76	3/16	4,98	10	<b>791.063.00*</b>
	12,7	1/2	4,76	3/16	5	10	<b>791.003.00</b>
	12,7	1/2	6,35	1/4	4,8	10	<b>791.010.00</b>
	13		5		4	10	<b>791.022.00</b>
	13		6		5	10	<b>791.023.00</b>
	15		6		5	10	<b>791.024.00</b>
	15,8	5/8	4,76	3/16	5	10	<b>791.018.00</b>
	15,8	5/8	6,35	1/4	5	10	<b>791.009.00</b>
	16		5		5	10	<b>791.006.00</b>
	16		8		5	10	<b>791.025.00</b>
	19	3/4	4,76	3/16	7,5	10	<b>791.019.00</b>
	19		6		6	10	<b>791.007.00</b>
	19	3/4	6,35	1/4	7	10	<b>791.004.00</b>
	19		8		6	10	<b>791.034.00</b>
	19	3/4	12,7	1/2	4	10	<b>791.011.00</b>
	22		8		6	10	<b>791.012.00</b>
	22		8		7	10	<b>791.005.00</b>
	22,2	7/8	4,76	3/16	7,5	10	<b>791.017.00</b>
	22,2	7/8	9,52	3/8	7	10	<b>791.021.00</b>
	22,2	7/8	12,7	1/2	7	10	<b>791.013.00</b>
	24		8		8	10	<b>791.036.00</b>
	28		12		8	10	<b>791.026.00</b>
	28,5	1-1/8	4,76	3/16	8,4	10	<b>791.014.00</b>
	28,5	1-1/8	8		8,5	10	<b>791.030.00</b>
	28,5	1-1/8	12,7	1/2	8	10	<b>791.027.00</b>
	31,7	1-1/4	8		5	10	<b>791.033.00</b>
	31,7	1-1/4	12,7	1/2	8	10	<b>791.015.00</b>
	34,9	1-3/8	4,76	3/16	11,5	10	<b>791.016.00</b>
	34,9	1-3/8	8		11,6	10	<b>791.031.00</b>
	34,9	1-3/8	12,7	1/2	11	10	<b>791.029.00</b>
	37		12		12	10	<b>791.028.00</b>
	38,1	1-1/2	12,7	1/2	13,3	10	<b>791.020.00</b>
	62		30		16	10	<b>791.051.00</b>
	62		35		14	1	<b>791.052.00</b>
	80		40		18	1	<b>791.054.00</b>
	80		50		16	1	<b>791.053.00</b>



<b>Delrin® Cylindrical Bearings</b>							
12,7	1/2	4,76	3/16	5	10	<b>791.044.00****</b>	
15,87	5/8	4,76	3/16	7,2	10	<b>791.045.00****</b>	
19,05	3/4	4,76	3/16	6,8	10	<b>791.046.00****</b>	
37,4	12,7	1/2	15,7	10	<b>791.047.00****</b>		
<b>10° Delrin® Conical Bearings</b>							
19	3/4	4,76	3/16	6,8	10	<b>791.041.00**</b>	
22	7/8	4,76	3/16	6,8	10	<b>791.048.00**</b>	
<b>Delrin® Triangular Bearings</b>							
12,7	1/2	4,76	3/16	5,8	10	<b>791.042.00***</b>	
19	3/4	4,76	3/16	7	10	<b>791.043.00***</b>	



**Shields for Bearings**

DESCRIPTION		ORDER NO.	DESCRIPTION		ORDER NO.
Ø9,5mm	10	<b>990.422.00</b>	Ø12,7mm	10	<b>990.423.00</b>

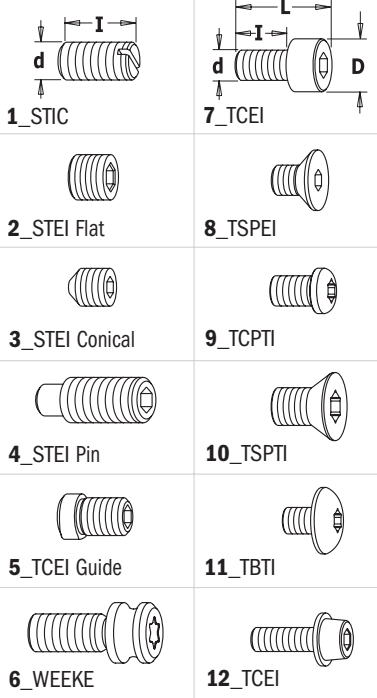

**Screws**

d x l x L mm	D mm	TYPE		ORDER NO.	d x l x L mm	D mm	TYPE		ORDER NO.
M5x8		1	10	990.008.00	M4x12x16	7	7	10	990.061.00
M5x10		1	10	990.003.00	M6x25x31	10	7	10	990.098.00
M2x2		2	10	990.060.00	M8x25x33	13	7	10	990.099.00
M4x4		2	10	990.016.00	1/8"x1/2"x5/8"	5,5	7	10	990.059.00
M4x20		2	10	990.091.00	M5x10x15	8,5	7	10	990.010.00
M5x4		2	10	990.015.00	M4x4x6	8	8	10	990.004.00
M5x5		2	10	990.001.00	M5x9x12	10	8	10	990.055.00
M5x5 w/cup point		2	10	990.006.00	M5x5,2x8	9	8	10	990.067.00
M3x3		3	10	990.005.00	M6x8x10	9	8	10	990.083.00
M5x5		3	10	990.002.00	M6x8,7x12	12	8	10	990.116.00
M6x6		3	10	990.007.00	1/4"x11/16"x7/8"	12	9	10	990.097.00
M4x3		3	10	990.013.00	1/8"x3/8"x1/2"	7	12	10	990.058.00
M4x4		3	10	990.014.00	M3x4x5,7 (T8)	4,6	9	10	990.082.00
M6x5		3	10	990.009.00	M4x5,5x8 (T20)	7,4	9	10	990.094.00
M6x8		4	10	990.087.00	M2,5x3x4,5 (T8)	3,5	10	10	990.070.00
M6x10		4	10	990.106.00	M2,5x4,5x6 (T8)	3,7	10	10	990.071.00
M6x16		4	10	990.066.00	M4x2x3 (T9)	6	10	10	990.079.00
M6x20		4	10	990.084.00	M5x3,6x6,1 (T25)	8,8	10	10	990.080.00
M6x25		4	10	990.085.00	M5x5x8 (T25)	9	10	10	990.093.00
M8x12		4	10	990.065.00	M5x13x18 (T15)	6,8	10	10	990.063.00
M8x16		4	10	990.064.00	M3,5x3,5x6 (T15)	6	11	10	990.072.00
M8x20		4	10	990.086.00	M3,5x4,8x6,8 (T15)	6	11	10	990.115.00
M5x5x9	6	5	10	990.068.00	M3,5x5x7,2 (T15)	8,8	11	10	990.073.00
M5x11,5x17		6	10	990.088.00	M3,5x5,7x8,2 (T15)	6	11	10	990.077.00
M2,5x6x8,5	4,5	7	10	990.062.00	M4x3,5x5,7 (T15)	8,8	11	10	990.074.00
M3x6x9	5,5	7	10	990.051.00	M4x4x6,2 (T15)	5,8	11	10	990.076.00
M3x10x13	5,5	7	10	990.053.00	M4x4x6,2 (T15)	8,8	11	10	990.056.00
M3x16x19	5,5	7	10	990.054.00	M4x6x8 (T15)	6	11	10	990.078.00
M4x6x10	7	7	10	990.052.00	M4x6x8,2 (T15)	9	11	10	990.075.00



**Keys for Screws**

DESCRIPTION		ORDER NO.	DESCRIPTION		ORDER NO.
<b>Hex Keys</b>			6mm	10	991.066.00
0,9mm (voor M2-bout)	10	991.055.00	<b>Torx Key</b>		
1,5mm (voor M3-bout)	10	991.056.00	T8	10	991.063.00
2mm	10	991.060.00	T9	10	991.069.00
3/32" (voor 1/8W-bout)	10	991.057.00	T15	10	991.061.00
2,5mm (voor M4-bout)	10	991.062.00	T20	10	991.072.00
3mm	10	991.067.00	T25	10	991.073.00
4mm	10	991.064.00	T30	10	991.071.00
5mm	10	991.065.00			

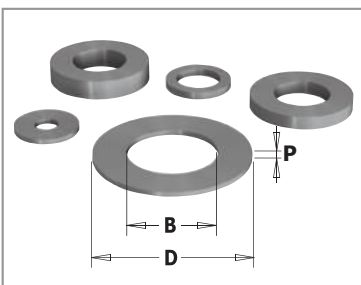

**Shields for Assembly**

B mm	D mm	P mm		ORDER NO.	B mm	D mm	P mm		ORDER NO.
3,25	9	1,6	10	541.550.00	8	14,7	5,8	10	541.519.00
3,25	15,8	2	10	541.552.00	12	20	2	10	541.512.00
5,2	15,8	2,5	10	541.551.00	12	20	3	10	541.511.00
6,4	9,52	2,2	10	541.514.00	12	21	0,1	10	541.513.00
8	14	0,1	10	541.515.00	12	21	0,3	10	541.520.00
8	14	0,3	10	541.516.00	12	21	1,59	10	541.521.00
8	14	0,5	10	541.517.00	12	21	3,18	10	541.522.00
8	14	1	10	541.518.00	12	21	6,16	10	541.523.00
8	14,7	3	10	541.500.00	12	21	1	10	541.524.00
8	14,7	4	10	541.501.00	12	21	0,5	10	541.525.00



**Nuts for Arbors**

DESCRIPTION		ORDER NO.	DESCRIPTION		ORDER NO.
M4	10	990.092.00	M8	10	990.020.00
M6	10	990.095.00	M12x1,25mm	10	990.022.00



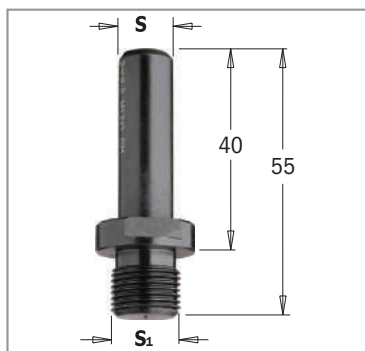

Arbors

797

S mm	S <sub>1</sub> mm			ORDER NO.
8	M10x1,5		10	797.580.00
10	M12x1		10	797.100.00
12	M12x1		10	797.120.00
12,7	M12x1		10	797.127.00

**TECHNICAL DETAILS:**

- Super strength steel.
- Precisely machined for accuracy.

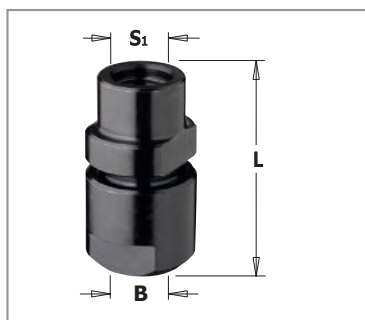

Collet Chucks

796

S <sub>1</sub> mm	B mm	L mm		ORDER NO.
M10x1,5	6 - 6,35 - 8 - 9,5	38	10	796.100.00
M12x1	6 - 6,35 - 8 - 9,5	38	10	796.000.00
M12x1	10 - 12 - 12,7	47	10	796.121.00

**TECHNICAL DETAILS:**

- Super strength steel.
- Precisely machined for accuracy.

Collet not included.



Router Chuck Extensions with Collet

796.001/002

S mm	COLLET INCLUDED mm	FOR COLLETS mm	L mm		ORDER NO.
12	8	6 - 6,35 - 8 - 9,5	81	10	796.002.01
12	12	10 - 12 - 12,7	88	10	796.002.00
12,7	6,35	6 - 6,35 - 8 - 9,5	81	10	796.001.01
12,7	12,7	10 - 12 - 12,7	88	10	796.001.00

**TECHNICAL DETAILS:**

- Super strength steel.
- Precisely machined for accuracy.

Collet included.

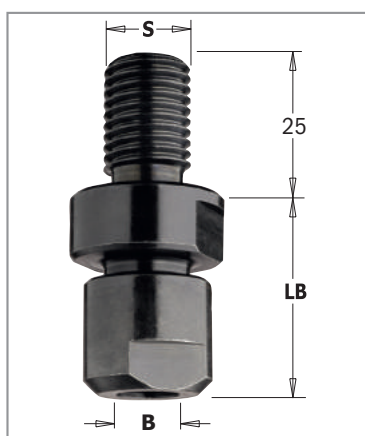

Collet Chucks

796

S mm	FOR COLLETS mm	LB mm		ORDER NO.
M14x2	6 - 6,35 - 8 - 9,5	32	10	796.140.00
M14x2	10 - 12 - 12,7	38	10	796.141.00
M16x2	6 - 6,35 - 8 - 9,5	32	10	796.160.00
M16x2	10 - 12 - 12,7	38	10	796.161.00

**TECHNICAL DETAILS:**

- Super strength steel.
- Precisely machined for accuracy.

Collet not included.



Collets

796.500/600

B mm		ORDER NO.	B mm		ORDER NO.
6	10	796.560.00	10	10	796.600.00
6,35	10	796.564.00	12	10	796.620.00
8	10	796.580.00	12,7	10	796.627.00
9,5	10	796.595.00			

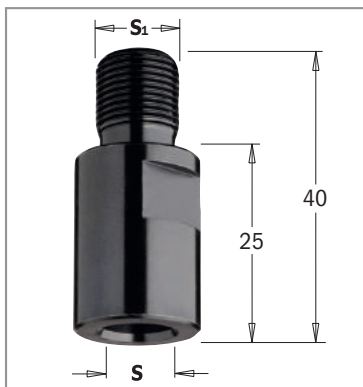

Arbors

798

S mm	S <sub>1</sub> mm		ORDER NO.
M10x1,5	M10x1,5	10	798.101.00
M10x1,5	M12x1	10	798.102.00
M12x1	M10x1,5	10	798.121.00
M12x1	M12x1	10	798.122.00

**TECHNICAL DETAILS:**

- Super strength steel.
- Precisely machined for accuracy.

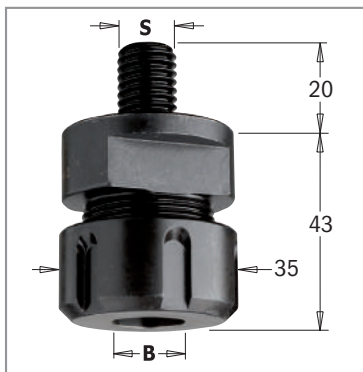

“ER20” Chucks

796

S mm	FOR COLLETS “ER20” mm	LB mm		ORDER NO.
M12x1,75	3 ~ 12,7	43	10	796.122.00
M14x2	3 ~ 12,7	43	10	796.142.00
M16x2	3 ~ 12,7	43	10	796.162.00

**Spare parts:** 992.483.03 M25x1,5mm clamping nut  
991.483.00 “ER20” key

**TECHNICAL DETAILS:**

Super strength steel. Precisely machined for accuracy.

Collet not included.

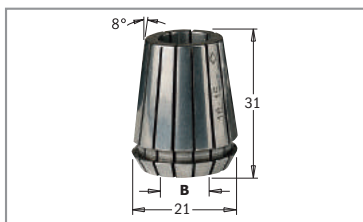

“ER20” Precision Collets for 796.122/142/162 Items

184

B mm		ORDER NO.	B mm		ORDER NO.
3	10	184.030.20	8	10	184.080.20
5	10	184.050.20	10	10	184.100.20
6	10	184.060.20	12	10	184.120.20
6,35	10	184.064.20	12,7	10	184.127.20

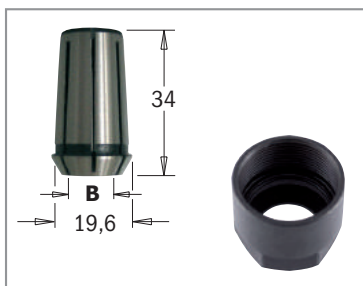

Collets for CMT1E, CMT2E, DeWalt®, Felisatti®, Fein®, Metabo® Hand-Held Routers 796.8

B mm		ORDER NO.	B mm		ORDER NO.
6	10	796.860.00	10	10	796.900.00
6,35	10	796.864.00	12	10	796.920.00
8	10	796.880.00	12,7	10	796.927.00
9,5	10	796.895.00			

**Spare parts:** 992.100.01 M22 clamping nut

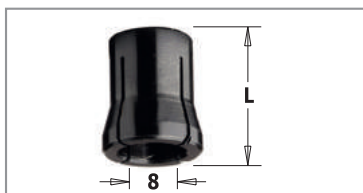

Collets for Freud®/Casals® Hand-Held Routers

796.780

B mm	L mm		ORDER NO.
8	14	10	796.780.00

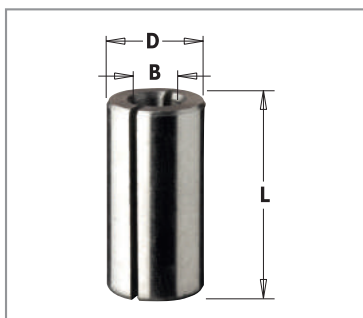

Bushings

799

B mm	D mm	L mm		ORDER NO.	B mm	D mm	L mm		ORDER NO.
6	8	25	10	799.060.00	8	10	25	10	799.280.00
6	9,5	25	10	799.160.00	8	12	25	10	799.380.00
6	12	25	10	799.260.00	8	12,7	25	10	799.480.00
6,35	8	25	10	799.064.00	9,5	12,7	25	10	799.001.00
6,35	9,5	25	10	799.164.00	10	12	25	10	799.100.00
6,35	12,7	25	10	799.264.00	13	16	45	10	799.130.00
8	9,5	25	10	799.180.00					

**541**

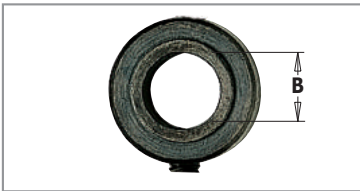

Stop Collars

B mm		ORDER NO.	B mm		ORDER NO.
3,175	10	541.008.00	9,5	10	541.006.00
6	10	541.003.00	12	10	541.005.00
6,35	10	541.001.00	12,7	10	541.002.00
8	10	541.004.00			

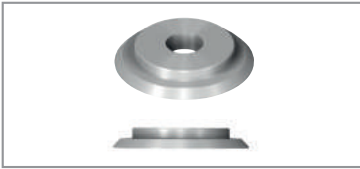

Threaded Rings for 694.001 Cutter Heads

**695.996**

DESCRIPTION		ORDER NO.
M4 (Ø10x1,6mm)	10	695.996.01
M4 (Ø12x1,7mm)	10	695.996.02

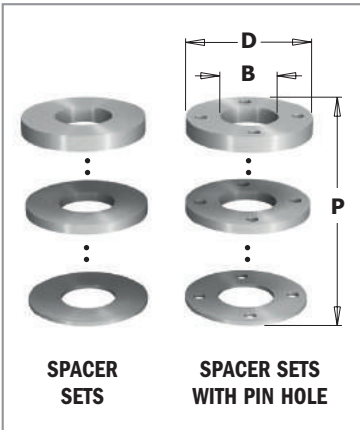

Spacers Set

**695.998**

DESCRIPTION D x B x P mm	FOR CUTTER HEAD		ORDER NO.	DESCRIPTION D x B x P mm	FOR CUTTER HEAD		ORDER NO.
<b>Spacer Sets</b>				<b>Spacer sets with Pin Hole</b>			
50x30x9	694.015	10	695.998.01	65x30x8	694.001 & 694.015	10	695.998.21
50x31,75x9	694.015	10	695.998.02	65x31,75x8	694.001 & 694.015	10	695.998.22
55x35x9	694.015	10	695.998.03	65x35x8	694.001 & 694.015	10	695.998.23
60x40x9	694.015	10	695.998.04	70x40x8	694.001 & 694.015	10	695.998.24N
70x50x9	694.015	10	695.998.05	70x50x8	694.001 & 694.015	10	695.998.25N
50x30x33	694.005	10	695.998.11				
50x31,75x33	694.005	10	695.998.12				
55x35x33	694.005	10	695.998.13				
60x40x33	694.005	10	695.998.14				
70x50x22	694.005	10	695.998.15				

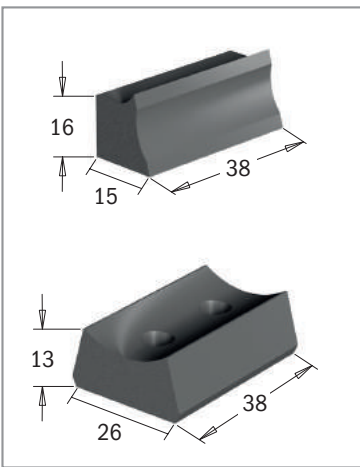

Wedges for Cutter Heads

**651-692-693-695**

DESCRIPTION		ORDER NO.	DESCRIPTION		ORDER NO.
<b>Wedge for Cutter Heads</b>			<b>Wedges for Router Bits with Knives</b>		
38x15x16mm	10	692.999.01	31x11x9,5mm	10	695.999.31
38x22,5x13mm	10	692.999.02	38x11x9,5mm	10	695.999.38
38x26x13mm	10	693.999.01	39x11x9,5mm	10	695.999.39
38x28x12,5mm	10	693.999.02	41x11x9,5mm	10	695.999.41
38x15x16mm (per/para 695.018)	10	695.018.01	42x11x9,5mm	10	695.999.42
7x11x9,5mm	10	695.999.07	46x11x9,5mm	10	695.999.46
16x11x9,5mm	10	695.999.16	49x11x9,5mm	10	695.999.49
17x11x9,5mm	10	695.999.17	53x11x9,5mm	10	695.999.53
22x11x9,5mm	10	695.999.22	D=8x20mm	10	651.999.01
23x11x9,5mm	10	695.999.23	D=10-12-12,7x30mm	10	651.999.02
23x11x9,5mm	10	695.999.24	D=12-12,7x50mm	10	651.999.03

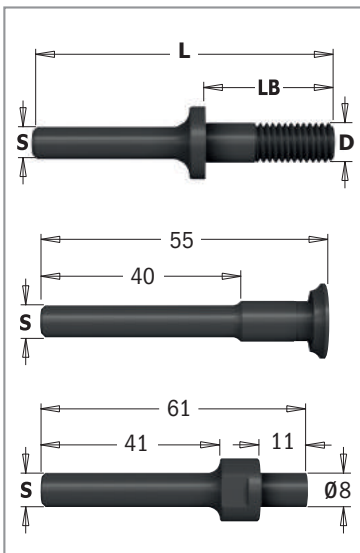

Slot Cutter Arbors

**7/8/924**

D mm	LB mm	L mm		ORDER NO. S=Ø6mm	ORDER NO. S=Ø6,35mm	ORDER NO. S=Ø8mm	ORDER NO. S=Ø12mm	ORDER NO. S=Ø12,7mm
<b>Arbors for 822 Slot Cutters</b>								
M8	26	61	10	724.060.00	824.064.00	924.080.00		
M8	40	86	10			924.083.00		
M8	26	67,5	10				924.120.00	824.127.00
M8	40	81	10				924.128.00	824.128.00
M12	54	97	10				924.129.00	824.129.00
M8	47	97	10				924.130.00	824.130.00
M8	29,75	71	10				924.131.00	824.131.00
M8	35,5	71	10				924.132.00	824.132.00
M8	23	71	10				924.133.00	824.133.00
M12	39,5	85	10				924.134.00	824.134.00
M12	54,5	100	10					824.135.00
<b>Arbors for 823 Slot Cutters with Counterbore</b>								
		55	10	724.061.00	824.061.00	924.081.00		824.121.00
8	11	61	10	724.062.00	824.062.00	924.082.00		824.122.00



# Alphabetical index

DESCRIPTION	PAGE
1 Piece Rail & Stile Cutter Heads.....	114
12 Corner Radius Router Template Set from 3mm to 25mm .....	376
12-Piece Router Bit Sets .....	228
13 Piece Multiprofile Cutter Head Sets without Limiters .....	116
13-Piece Router Bit Sets .....	228
15-Piece Router Bit Sets .....	227
15° Dovetail Cutter with Insert Knives for Roof-Frames .....	186
1KW Router .....	352
2 Flute Dowel Drills .....	302-303
2 Flute Dowel Drills for Through Holes .....	308-309
2 Piece Adjustable Grooving Sets.....	99
2 Piece Adjustable Rounding & Chamfering Sets.....	101
2-Piece Entry Door Router Bit Set.....	231
2.4KW Router .....	353
26-Piece Router Bit Sets .....	227
3 piece Adjustable Grooving Sets.....	98
3-Flute Slot Cutter for STRIPLOX™ .....	219
3-Flute Solid Carbide Countersink 90° .....	310
3-in-1 Flush Trim Bits for MDF/Laminate .....	164
300W Oscillating Multi-Tools.....	355
3D Router Carver System.....	372-374
4 Flute Dowel Drills .....	304-306
4 Flute Dowel Drills for Through Holes .....	309
4-Wing Cut Out Slot Cutters for Solid Surfaces .....	223
45° Chamfer Cutter Heads .....	102
45° Countersink with Parallel Shank .....	334
45° Lock Miter Cutter Heads .....	109
5-Piece Boring Bit Set for Hinges.....	320-321
5-Piece Spiral Bit Sets.....	237
5-Piece Straight Bit Set & Profile Bit Set.....	236
5% Co HS Spiral Bits for Aluminium Positive Single Flute .....	153
5% Co HS Spiral Bits for High Cutting Depth .....	153
550W Professional Trimmer.....	354
6-Piece Mortising Bit Sets.....	284-285
6-Piece Profile Bit Sets.....	230
60° Lettering Bit.....	187
7 Piece Multiprofile Cutter Head Sets with Limiters .....	117
9° Dovetail Cutters.....	186
90° Countersink with Parallel Shank .....	334-335

DESCRIPTION	PAGE
<b>A</b>	
Adapters.....	292-294, 318-319
Adapters for Twist Drills.....	300
Additional Templates, Bits & Accessories .....	363
Adjustable Chamfer Cutter Heads with Positive Stop .....	103
Adjustable Chamfering CNC Cutter .....	280
Adjustable Countersink .....	332
Adjustable Double Roundover Router Bits.....	204
Adjustable Precision Router Dado Jig.....	361
Adjustable Roundover & Bevel Router Bits.....	204
Adjustable Scoring Blades Industrial Line .....	23
Adjustable Shaker Router Bit Sets .....	235
Adjustable Tongue & Groove Bit Set for Mission Style Cabinet Doors.....	235
Auger Bits .....	328
<b>B</b>	
Back-to-Back Connectors for Straight Edge Clamps (optional) .....	360
Ball End Bit .....	194
Bead & Bull Nose Bits .....	206
Beading Bits .....	197
Bench Block Set .....	368
Bi-Metal Plus Hole Saws .....	344-345
Biscuit Joiner Saw Blades .....	39
Blank Knives & Limiters (to be sharpened) .....	132
Blum Hinges Boring Head .....	368
Boring Bit & Plug Cutter Sets.....	325
Boring Bits with Parallel Shank.....	320-323
Boring head System 32 .....	368
Bowl & Tray Bits .....	187
Bowl & Tray System.....	381
Brad Point Bit Sets .....	330
Brad Point Bits.....	328, 330-331
Bushings for Twist Drills.....	300
<b>C</b>	
C-Spanner for "DIN6388" & "ER40" .....	252
C-Spanner for "ER32" Precision Collets.....	251
C-spanner for "ER40" Precision Collets .....	249
Calibration & Sanding Disks .....	40
Cap Nuts for CNC Machines .....	254

# Alphabetical index

DESCRIPTION	PAGE	DESCRIPTION	PAGE
Carbide Spiral Slot Mortising Bits with Chip-Breaker .....	287	<b>D</b>	
Carpenter Pencil .....	382	Dado & Planer Bits .....	157
Cavetto Edge Mould Bits .....	196	Dado Saw Blades .....	37
Chamfer Bit .....	242	Decorative Beading Bits .....	200
Chamfer Bits .....	191-192	Decorative Ogee Bit .....	199, 201, 241
Chamfer Bits with Insert Knives .....	191	Diamond Dry Hole Saws .....	346-348
Chamfer Set .....	192	Diamond Whetstones .....	380
Chucks & "ER20" Collets for Spindle Moulder Machine .....	132	Digital Angle Finder .....	379
Chucks for "ER32" Precision Collets .....	251	Digital Angle Gauge .....	379
Circular Saw Blade for Patch Work & Repair .....	40	Digital Height Gauge .....	378
Clamping Nuts .....	252	Digital Moisture Meter .....	378
Clamping Nuts for Chucks with "ER32" Collets .....	251	Display Cabinet for Drill & Boring Bits .....	390
Clamping Nuts for Chucks with "ER40" Precision Collets .....	249	Display Cabinet for Hole Saws .....	389
Classical Bead Bits .....	200	Display Cabinet for Multi-Cutters .....	386
Classical Ogee Bits .....	202, 244	Display Cabinet for Router Bits .....	387
CMT Contractor Tools® Saw Blade Combo .....	36	Display Cabinet for Router Bits & Forstner Bits .....	388
CMT Contractor Tools® Saw Blade Masterpack .....	36	Display Cabinets for Sabre & Jig Saw Blades .....	385
CMT Inlay Kit .....	369	Display Cabinets for Saw Blades .....	384
CMT Moulding System .....	207	Divided Light Door Sets .....	229
CMT Professional Tool Bag .....	382	Double-Bearing Spiral Flush Trim Bits .....	164
CMT's Complete Kitchen Set .....	233	Double-Edge Trimmer .....	377
Collets for 123 Chucks .....	254	Dovetail Bit .....	184-185, 242
Combination Trimmer Bits .....	160-161	Dowel Drills .....	298
Complete Set for Decorating on MDF .....	281	Dowel Drills for Mafell® & Hand-Held Routers .....	329
Complete Set for MDF Doors .....	282-283	Dowel Drills for Through Holes .....	299
Conical Scoring Blades Industrial Line .....	24	Dowel Drills for Through Holes with Countersink .....	307
Corner Beading Bit with 45° Chamfer .....	205	Dowel Drills with Countersink .....	307
Corner Beading Bits .....	206	Dowel Drills with Threaded Shank .....	316
Countersinks for 2 Flutes Dowel Drills .....	310	Dowel Drills with Threaded Shank with Countersink .....	314-315
Countersinks for 4 Flutes Dowel Drills .....	310	Dowel Drills with Threaded Shank without Countersink .....	314-315
Countersinks with Threaded Shank .....	332	DP Conical Scoring Blades XTreme Line .....	22
Cove Bit Set .....	195	DP Corner Rounding Router Bits for Composites and Laminates .....	199
Cove Bits .....	195, 243	DP Flush Trim Bits for Laminates .....	163
Crosscut Saw Blades for Portable Machines .....	34	DP Hinge Boring Bits with Chipbreaker .....	311
Cutter Arbor with HSK Tapered Shank .....	256	DP Laminated & Chipboard Saw Blades XTreme Line .....	22
Cutter Heads for Rabbeting with 40mm Profile Knives .....	97	DP Router Cutters .....	270
Cutter Heads with Limiters .....	115	DP Router Cutters with 20° Shear Angle .....	272
Cutter Heads without Limiters .....	115	DP Router Cutters with 40° Shear Angle .....	274
Cutting & Filing Tools for Multi-Cutters .....	79-80	DP Router Cutters with 45° Shear Angle .....	271
Cutting & Scraping Tools for Multi-Cutters .....	81-82	DP Router Cutters with Negative Shear Angle .....	270
Cutting Tools for Multi-Cutters .....	73-78	DP Router Cutters with Shear Angle .....	271-272

# Alphabetical index

DESCRIPTION	PAGE
DP Router Cutters with Shear Angle for Nesting (Densimet® Tungsten Heavy Metal Alloys).....	273
DP Saw Blades for Ultra-Hard Materials.....	33
DP Spiral Router Cutters with Shear Angle.....	273
Drawer Lock Bits.....	179
Drill Bit with Countersink for Screw Joints.....	335
Drill Bits for ANUBA Hinges.....	331
Drill Bits with 45° Countersink Set.....	333
Drill Bits with 90° Countersink Set.....	333
Dry Cutter Saw Blades for Metal Industrial Line.....	28

## E

Edge Banding Bits Set.....	183
Edge Banding End Trimmer.....	377
Edge Banding Iron.....	377
Edge-Fluting Bits.....	207
Ellipse & Circle Cutting Jig.....	364
Entry & Interior Door Router Bit Set.....	230

## F

<b>FILE-FREE</b> Flush Trim Bits for Laminate.....	165
Fine Cut-Off Saw Blades for Portable Machines.....	35
Fine Cut-Off Saw Blades for Two-Sided Melamine Industrial Line.....	15
Fine Cut-Off Saw Blades for Two-Sided Melamine Industrial Line.....	16-17
Finger Joint Bit.....	182
Finger Pull Bit.....	211, 245
Finger pull door lip bit.....	210
Finishing Saw Blades Industrial Line.....	13
Flexible Templates for Curved & Arched Routing.....	376
Flooring Router Bits.....	172
Flush Trim Bit Set.....	162
Flush Trim Bits.....	162, 240
Flush Trim Bits with Insert Knives.....	165
Flush Trim Router Bits with Double Bearing.....	166
Flute & Bead Set.....	176
Folding Ruler.....	382
Formula 2050: Blade & Bit Cleaner.....	375
Forstner Bit Sets.....	326
Forstner Bits.....	326

DESCRIPTION	PAGE
<b>G</b>	
Garden Trimmer Saw Blades.....	32
Glass Panel Sets.....	229
Grand Rabbeting Bits with Insert Knives.....	169
Grinding Wheels for XTreme Sharpening.....	296
Grooving Saw Blades.....	39
Grooving Saw Blades Industrial Line.....	38
Guide to Choosing the Most Suitable Jig Saw Blade.....	52

## H

Hinge Boring Bits.....	312-313
Hinge Boring Bits with Chipbreaker.....	312
Hinge Recesser Bits.....	157
Hole Saw Application Chart.....	339
Hole Saws Accessories.....	343
HS Corrugated Back Moulder Knives.....	133
HSK Chuck for Grooving Blade.....	255
HSK Chuck for "DIN6388" - EOC25 Precision Collet.....	252
HSK Chuck for "ER32" Precision Collets.....	250
HSK Chucks for "ER40" Precision Collets.....	249
HWM Reversible knives.....	136-137
HWM Reversible Knives for Portable Planers.....	138

## I

Industrial Chrome-Coated Adjustable Scoring Blades.....	23
Industrial Chrome-Coated Scoring Blades.....	24
Industrio Routing System.....	357
Interchangeable Boring Bits with Threaded Shank.....	319
ISO30 Chucks for "ER32" Precision Collets.....	250
ISO30 Chucks for "ER40" Precision Collets.....	249
ISO30 Retaining Studs.....	254
ITK-Plus® Crosscut Saw Blades.....	31
ITK-Plus® Fine Cut-Off Saw Blades.....	31
ITK-Plus® Non-Ferrous Metal & Composite Decking.....	32
ITK-Plus® Rip & Crosscut Saw Blades.....	30
ITK-Plus® Ripping Saw Blades.....	30

## J

Jig Saw Blades.....	53-57
Junior Oggee Rail & Stile Set.....	213



# Alphabetical index

DESCRIPTION	PAGE
<b>K</b>	
Keyhole Bit.....	171, 241
Kinetic Dust Extractor.....	248
Kitchen Sets.....	234
Kitchen Worktop Jig.....	365
<b>L</b>	
Laminate/Veneered-Panel Cutter.....	377
Laminated & Chipboard Saw Blades Industrial Line.....	19
Laminated & Chipboard Saw Blades XTreme Line.....	19
Laser Point Bit.....	189
Lock Miter Bits.....	177
Lock Miter Set.....	176
Low Noise & Chrome Coated Saw Blades with ATB Grind.....	14
Low Noise & Chrome Coated Saw Blades with TCG Grind.....	18
Lubricant for Wood, Neutralizes Resin.....	375
<b>M</b>	
Maximizing Boring Performance.....	295, 311
Maximizing Saw Performance.....	8
Melamine & Laminated Long-Lasting Saw Blades XTreme Line.....	18
Mortise Chisel & Bit Sets.....	323
Mortising Bits.....	156
Moulding Bits.....	209-210
Multi Tools Mini Counter Display.....	391
Multi-Material Saw Blades.....	21
Multi-Purpose Hole Saws.....	340-341
Multi-Purpose Long Hole Saws.....	342
Multi-Purpose with Countersink Hole Saws.....	343
Multi-Rip Anti-Kickback Saw Blades Industrial Line.....	9
Multi-Rip Saw Blades with Rakers Industrial Line.....	9
Multiprofile Bits.....	208
Multiradius Roundover Cutter Heads.....	104-105
<b>N</b>	
New Professional Router Table.....	356
Non-Ferrous Metal & Laminated Panel Saw Blades Industrial Line.....	27
Non-Ferrous Metal & Plastic Material Saw Blades Industrial Line.....	26
<b>O</b>	
Ogee Bits.....	203

DESCRIPTION	PAGE
Ogee with Fillet Bits.....	203
Organizer.....	374
Ovolo Bit.....	243
Ovolo Bits.....	196
Ovolo Sash Bits.....	181
Ovolo Sash Set.....	181
<b>P</b>	
Pair of Bore Reducers.....	132
Panelalign Strips.....	233
Panel Pilot Bits with Guide.....	167
Panel Sizing Saw Blades Industrial Line.....	25
Pattern Bits.....	158, 240
Pattern Router Bits with Insert Knives.....	159
Pattern Router Bits with Insert Knives for Laminates.....	159
Pattern/Flush Trim Bits with Insert Knives.....	166
Planer & Jointer Knives.....	134-135
Planing & Jointing Spiral Cutter Heads.....	100
Plug Cutters.....	324
Plunge Ogee Bits.....	201
Plywood Groove Set.....	150
Pocket-Pro™ Joinery System.....	358
Precision Collets “ER20” for 796.122/142/162 Items.....	132
Precision Collets “DING388”.....	252
Precision Collets “DING499”.....	253
Professional Adjustable Chamfer Cutter Heads with Gear Box.....	103
Professional Finger Joint Bit.....	182
Professional Finger Joint Cutter Heads.....	107
Professional Raised Panel Cutter Heads.....	111
Professional Straight Edge Clamps.....	360
Profile & Counter Profile Cutter Head Sets.....	112-113
Profile Knives and Limiters.....	118~131
PVC & Plexiglass Saw Blades Industrial Line.....	29
<b>R</b>	
Rabbeting Bit.....	169, 243
Rabbeting Bits with Insert Knives.....	170
Rabbeting Cutter Heads.....	96
Rabbeting Sets.....	170
Rail & Stile Set.....	213, 215
Raised Panel Bit with Back Cutter.....	217

# Alphabetical index



DESCRIPTION	PAGE
Raised Panel Bits.....	216
Raised Panel Cutter Heads .....	110
Reciprocating Slot Mortising Bits.....	288-290
Reduction Rings for Saw Blades.....	40
Replacement Bearing Set.....	245
Reverse Glue Joint Bits.....	178
Reverse Glue Joint Cutter Heads.....	108
Rip & Crosscut Saw Blades Industrial Line.....	12
Rip Saw Blades for Portable Machines.....	33
Rip Saw Blades Industrial Line.....	11
Roman Ogee Bit.....	202, 244
Rosette Cutters .....	327
Round Nose Bits.....	193, 240
Round Nose Set .....	194
Round Nose Solid Carbide Upcut Spiral Bits.....	268
Roundover & Beading Bits.....	244
Roundover & Cove Cutter Heads .....	106
Roundover Bits.....	198
Roundover Bits with Insert Knives .....	197
Roundover Set.....	198
Router Bit Set with Insert Knives.....	237
Router Bits for Domino® Joining Machines by Festool® .....	329
Router Cutters.....	275-277

## S

Sabre Saw Blades.....	58-68
Sanding & Cleaning Tools for Multi-Cutters.....	83
Saw Blade Arbor with Parallel Shank .....	254
Saw Blade Index.....	41-48
Saw Blades for Building Contractors.....	11
Saw Blades for Portable Machines .....	49-50
Saw Blades for Stainless Steel .....	28
Saw Blades Stabilizers.....	40
Screw Slot Bits.....	172
Set of 2 Magnetic Knife Setting Jigs.....	133
Slot & Mortise Boring Bits.....	286-287
Slot Cutter Sets.....	236
Slot Cutters .....	174-175, 242
Slot Mortising Bits.....	290
Slot Mortising Bits with Chip-Breaker .....	284
Small Arch Door Sets .....	232

DESCRIPTION	PAGE
Small Stock Holder .....	359
Solid Carbide Dowel Drills.....	295-297
Solid Carbide Dowel Drills for Through Holes .....	297
Solid Carbide Downcut Spiral Bits .....	259, 261
Solid Carbide Downcut Spiral Bits with Chip-Breaker.....	265
Solid Carbide Router Cutters .....	275-276
Solid Carbide Spiral Bits .....	146-147
Solid Carbide Spiral Bits Downcut .....	263
Solid Carbide Twist Drills "V" Point 60° Sharpening.....	301
Solid Carbide Twist Drills "V" Point Sharpening.....	301
Solid Carbide Twist Drills Negatively Ground Spurs Sharpening.....	301
Solid Carbide Up & Downcut Spiral Bits.....	258
Solid Carbide Upcut 2D/3D Carving Tapered Ball Nose Spiral Bits .....	268
Solid Carbide Upcut Spiral Bits.....	259
Solid Carbide Upcut Spiral Bits.....	262
Solid Carbide Upcut Spiral Bits .....	260, 264
Solid Carbide Upcut Spiral Bits for Aluminum and PVC .....	153
Solid Carbide Upcut Spiral Bits for Locksets.....	266
Solid Carbide Upcut Spiral Bits with Chip-Breaker.....	264
Solid Carbide Upcut Spiral Bits without Chip-Breaker for 60° V-Point Locksets.....	266
Solid Carbide Upcut with Spiral Bits Chip-Breaker for 60° V-Point Locksets .....	266
Solid Surface - Inlay Bits .....	225
Solid Surface and Fiberglass Bit.....	269
Solid Surface Bevel Bit .....	222
Solid Surface Bevel Bowl Bits .....	222
Solid Surface Counter-Top Trim Router Bits.....	219
Solid Surface Cut & Plug Repair Set.....	223
Solid Surface Decorative Edge Profile Bits .....	220
Solid Surface Drainboard Bits.....	225
Solid Surface No-Drip Bit.....	224
Solid Surface Rounding Over Bits.....	220
Solid Surface Rounding Over Bowl Bit (ogee profile) .....	221
Solid Surface Rounding Over Bowl Bits .....	221
Solid Surface Saw Blades Industrial Line.....	29
Solid Surface Sink & Trim Bits.....	226
Solid Surface Sink & Trim Bits with Insert Knives .....	226
Solid Surface Wavy Joint Bit.....	224
Spare Part & Accessories .....	392-396
Spare Parts for Chucks.....	256
Spiral Bits with Insert Knives & Chip-Breaker for Locksets.....	267
Spoilboard Surfacing Router Cutters with Insert Knives .....	278

# Alphabetical index

DESCRIPTION	PAGE	DESCRIPTION	PAGE
Step-By-Step Window Sash Construction.....	180	<b>U</b>	
Stepped Rebate Router Bit.....	190	Universal Assembly Supports for Chucks.....	256
Stile & Panel Router Bits.....	218	Universal Boring Jig.....	371
Stop Collars.....	328	Universal Boring Template.....	370
Stop Collars with Delrin® Sleeve.....	333	Universal Dovetail Jig.....	362
Straight Bits.....	150, 239	Universal Hinges Boring System.....	366-367
Straight Bits with Centre Tip.....	148, 239	Universal Profile Cutter for CNC Machines.....	279
Straight Bits, Long Series.....	149	Upcut Spiral Bits with Chipbreaker for Glue-Laminated Wooden Beams.....	267
Straight Bits, Short Series.....	151	<b>V</b>	
Straight Cutters with Threaded Shank.....	152	V-Groove - Folding - Signmaking CNC Router Cutters with Insert Knives.....	280
Straight Router Bits with Insert Knives.....	154-155	V-Groove Bits.....	241
Straight Router Bits with Insert Knives for Laminates.....	154	V-Grooving & Signmaking Router Bits with indexable knives (90°).....	190
Straight Router Cutters with Insert Knives.....	278	V-Grooving Bits.....	189
Super Fine Finishing Blade XTreme Line.....	16	V-Grooving Bits (90°).....	188
Super Finishing Saw Blades for Cutting Frames XTreme Line.....	13	V-Tongue & Groove Set.....	183
Super-Duty Flush Trim Bits.....	163	Vertical Raised Panel Bits.....	212
<b>T</b>		<b>W</b>	
T-Slot Bits.....	171	Wainscot/Paneling Bits.....	205
Table Edge & Hand Rail Bits.....	212	Weatherseal Bits.....	160
Template Guide Kit.....	369	What work parameters are best when routing?.....	246
Tenon Cutting Router Bits.....	231	Window Sash Set.....	180
The ABC's of Panel Door Construction.....	214	Window Sill & Finger Bits.....	211
The Cabinetmaking Sets.....	232		
The CMT Grand Rabbet Set.....	168		
The Raised Panel Sets with Backcutter.....	234		
Thick-Kerf Multi-Rip Saw Blades with Rakers Industrial Line.....	10		
Three Wing Slot Cutter Set.....	173		
Tongue & Groove Set.....	173		
Tools for Multi-Cutters.....	70~72, 84~94		
Twisted Slot Mortising Bits with Chip-Breaker.....	285		



# Numerical index



ORDER NO.	PAGE	ORDER NO.	PAGE	ORDER NO.	PAGE	ORDER NO.	PAGE	ORDER NO.	PAGE
01.02	296	183.100	251	240.004.04	40	313.41/42	299	377	307
03.00.0002	388	183.200	250	241	39	314	308	380	329
03.00.0030	384	183.201	249	271	30	314.21/22	297	381	309
03.00.0038	384~386, 389	183.210	250	272	31	314.41/42	299	382	297
03.00.0042	387, 390	183.211	249	273	31	315	310	392	323
03.00.0043	391	183.220	250	274	16	316	310	500.001.08	325
03.51	374	183.250	250	276	32	317	311~313	500.002.08	325
03.53.0011-X24	385~389	183.251	250	277	10	317C	312	500.003.08	325
03.53.0012-X24	384~386, 391	183.260	256	278	9	325	315	501	319
03.53.0013-X24	389	183.300	250	279	9	327	315	503	319
03.53.0014-X12	391	183.310	249	280	10	329	315	506	318
03.53.0017	387, 390	183.320	252	281	12, 18-19, 25, 35	330	315	509	318
03.53.0020-X12	385, 391	183.360	256	282	25	332	314	511	318
03.53.0038	386, 389	183.400	251	283	15	334	314	512	320-321
102	284	183.410	254	284	26	336	314	512.001.00	321
103	288	183.420	255	285	11~14, 34-35	337	314	512.001.01	320
104	289	183.421	255	285.5	13	338	315	513	322
105	289	183.422	255	286	11	339	315	514	322
106	290	184	132, 253, 395	287	16-17	340	315	515	331, 334-335
107	290	185	252	288	24	341	314	515A	333
112	276	186	153	289	23	342	314	516	331
113	276	188	153	290	11, 33	343	314	517	330
123	254	189	153	291	12, 34	344	316	521	310, 334-335
124	254	190	146, 258	292	35	346	316	521.001	332
140	271	190B	164	293	11	350	332	521A	333
141	270	191	147, 237, 260	294	12-13	351	332	522	186
142	272	191.143	266	295	12, 18	352	316	523	186
143	273	191.163	266	296	27	353	316	529	324
145	274	191.635	160	297	27	358	293	530	324
151	269	191B	164	298	32	359	293	531	327
152	268	192	147, 237, 261	299	40, 99	360.001	293	532	318
160	285	192B	164	299.10	40	360.101	294	533	318
161	285, 287	193	262	299.11	40	360.201	294	534	319
163	287	193.221	249	301	292	360.301	294	535	328
164	286	194	263	302	292	360.401	294	537	326
166	286	195	264, 266-267	303	292	361	302	537.000.04	326
167	286	195.143	266	304	292	362	303	537.000.05	326
170	152	195.163	266	305	293	363	301	537.000.07	326
171	152	196	265	306	304	364	300	537.000.12	326
172	284	197	264	307	304	365	300	537.000.16	326
173	152	198	146, 259	308	305	366	308	540	328
174	148, 275	199	193, 268	309	305	367	309	541	328, 333, 393, 396
175	277	222	29	310	302	368	309	542	328
176	277	223	29	310.21/22	296	369	311~313	542.100.51	342
177	148, 277	226	28	310.41/42	298	369C	312	543	323
179	288	230	37	311	303	370	313	550	340-341
180	152	235	20-21	311.21/22	296	372	306	550-EX1	343
181	152	236	33	311.41/42	298	373	306	550-EX2	343
182	152	237	22	311.71/72	295	374	309	550-HS2XL	343
183	256	238	22	312	329	375	309	550-HW2XL	343
183.000	251	240	38-39	313	308	376	307	550-SDS1	343

ORDER NO.	PAGE	ORDER NO.	PAGE	ORDER NO.	PAGE	ORDER NO.	PAGE	ORDER NO.	PAGE
550-SDS2	343	691	118-132	716.061	167	796.002	394	813.001	160
550CS	343	692	115-116, 396	718	184-185	796.500	394	814	193-194
551	344-345	693	115-116, 396	718B	184-185	796.600	394	814B	193
551-HS1	345	694.001	98	721	160	796.8	395	815	188
551-HS2	345	694.002	102	722A	174	797	394	815B	188
551-HS2XL	343	694.003	104	724	175, 396	797.780	395	816	167
552	346-347	694.004	105	724.xxx.00	174	798	395	818	184-185
552-0	348	694.005	101	724.xxx.10	174	799	395	818B	184-185
552-001-05	348	694.007	106	727	196	800.001	227	821	160
552-5	348	694.008	107	735	169	800.005	236	822	174
552-501-06	348	694.009	108	735.001	170	800.503	228	822.023B	172
552-DD1	347	694.011	109	736	192	800.504	230	822.024B	172
552-DD2	347	694.012	110	737	195	800.505	228	822.033B	223
552-EX14	348	694.013	111	738	198, 220	800.506	173	822.034	219
552-GUIDE	348	694.014	114	739	197	800.509	233	822A	174
552-WAX	347	694.015	112-113	740	202	800.510	233	822B	174
553	342	694.017	103	741	202	800.511	233	823	175
553-CP2	342	694.018	103	742	161	800.512	234	823.001	236
553-HW10	342	694.019	100	743	161	800.513	234	823.371	219
600.005	237	694.020	97	744	202	800.514	234	823B	175
615.004.01	282-283	694.021	99	745	202	800.515	232	824	175, 396
615.200D	282-283	694.022	99	746	203	800.516	234	824.xxx.00	174
615.350A	282-283	694.100	96	747	203	800.517	234	824.xxx.10	174
615.500A	282-283	695	396	748	201	800.518	234	827	196
615.620A	282-283	695.996	396	748B	201	800.520	232	835	169
616.000.01	281	695.998	396	749	187	800.521	234	835.001	170
616.200	281	699	132	750.0	171	800.522	234	835.503	168
651	154, 396	700.005	236	751	187	800.524	232	835.990	168
652	154	701	156	751B	187	800.525	229	836	192
652B	159	701B	156	753	167	800.527	230	837	195
653	155, 278	702	157	754	206	800.606	182	838	198, 220
654	155	703	191	755	179	800.616	182	839	197
655	155	704	191	758	189	800.622	204	840	202
656	159	705	191	759	203	800.623	204	841	202
657.1	165	706	162-163	760	203	800.624	235	842	161
657.9	165	707	161, 164	761	206	800.625	235	843	161
657B	166	709	161	762	207	800.626	173	844	202
658	191	710	161	763	196	800.627	231	845	202
659	191	711	150-151	764	196	800.628	231	846	203
660	170	711.031	160	765	200	801	156	847	203
660.9	169	711B	158	765.1	201	801B	156	848	201
661.11	197	712	149	765B	200	806	162-163	848B	201
661.41	197	712.030	160	790	136-138	806B	166	849	187
662	267	712.040	160	791	392	807	161, 164-165	849B	187
663	278	712B	158	791.703	170	809	161	850.0	171
663.1	280	713.001	160	79101	245	811	150-151	850.6	171
663.201	280	714	193	792	134	811B	158	851	187
663.301	279	714B	193	793	133	812	149	851B	187
664	186	715	188	795	135	812.032	160	852	157
665	190	715B	188	796	132, 394-395	812B	158	852B	157
690	118-132	716	167	796.001	394	813	172	853	167

# Numerical index



ORDER NO.	PAGE	ORDER NO.	PAGE	ORDER NO.	PAGE	ORDER NO.	PAGE	ORDER NO.	PAGE
854	206	880.521	220	903	191	954	205-206	980.541	221
855	176, 179, 211	880.531	224	904	191	955	176, 179, 211	980.542	221
855.3	181	880.541	221	905	191	955.3	181	980.551	222
855.501	178	880.542	221	906	162-163	955.302	181	980.56	226
855.503	177	880.551	222	906B	166	955.501	178	980.57	226
855.504	177	880.56	226	907	164-165	955.503	177	981.501	224
855.506	183	880.57	226	909	161	955.504	177	981.511	225
855.510	183	881.501	224	910	161	955.506	183	981.512	225
855.604	210	881.511	225	911	150-151	955.510	183	981.521	222
855.606	210	881.512	225	911B	158	955.604	210	981.531	224
855.701	176	881.521	222	912	149	955.701	176	981.541	223
855.8	211	881.531	224	912B	158	955.8	211	990	216, 392-393
855.801	180	881.541	223	913	172	955.801	180	990.0	393
855.802	181	890	216	914	193	955.803	229	990.088	294
855.803	229	890.5	217	914B	193	955.806	231	990.5	217
855.806	231	890.6	212	915	188-189	955.8B	211	990.6	212
855.8B	211	891	213, 215	915B	188	955.901	209	991	213, 215, 393
855.901	209	891.517	213	916	167	955.902	209	991.183	251
855.902	209	891.521	215	918	184-185	956.501	209	991.184	249
856.501	209	899	369	921	160	956.601	212	991.283	252
856.601	212	900.001	227	922.033B	223	956.701	212	991.517	213
856.701	212	900.003	227	922A	174	956.702	212	991.521	215
856.702	212	900.005	236	922B	174	956.8	208	992	248
856.8	208	900.005	236	923.001	236	956.851	207	992.183	251
856.851	207	900.024	232	923A	175	956.852	207	992.283	252
856.852	207	900.025	229	924	175, 396	957	192	992.383	249
857	192	900.506	173	924.xxx.00	174	958	189	993.0	254
858	189	900.509	233	924.xxx.10	174	959	203	998	375
859	203	900.510	233	927	196	960	203	999.110.00	356
860	203	900.511	233	935	169	961	206	999.500.01	357
861	206	900.512	234	935.001	170	961.6	105	BAG-001	382
861.6	105	900.513	234	935.503	168	963	196	BBS-001	368
862	207	900.514	234	935.990	168	964	196	BTS-002	381
863	196	900.516	234	936	192	965	190, 200	CMT-TGA	369
864	196	900.517	234	937	195	965.1	201	CMT10	354
865	200	900.518	234	938	198-199, 220	965.9	199	CMT11	355
865.1	201	900.521	234	939	197	965B	200	CMT300	362-363
865.9	199	900.522	234	940	202	966.501	222	CMT3000	364
865B	200	900.527	230	941	202	966.601	221	CMT333	366-367
866.501	222	900.606	182	944	202	966.602	221	CMT333-325	368
866.601	221	900.616	182	945	202	967.5B	210	CMT334	368
866.602	221	900.622	204	946	203	967.6B	210	CMT650	365
867.5B	210	900.623	204	947	203	967.701	209	CMT656	371
867.6B	210	900.624	235	948	201	968	194	CMT792	133
867.701	209	900.625	235	948B	201	970	218	CMT7E	353
868	194	900.626	173	949	187	980.5	220	CMT8E	352
870	218	900.627	231	949B	187	980.511	225	CMT900	370
880.5	220	900.628	231	950.0	171	980.512	225	DAF-001	379
880.511	225	901	156	950.6	171	980.513	225	DAG-001	379
880.512	225	901B	156	951	187	980.521	220	DET-001	377
880.513	225	902	157	953	167	980.531	224	DET-002	377



# Numerical index

ORDER NO.	PAGE	ORDER NO.	PAGE	ORDER NO.	PAGE	ORDER NO.	PAGE	ORDER NO.	PAGE
DET-003.....	377	JS922BF.....	67	K935.....	243	OMF233.....	74	OMS02.....	85
DET-004.....	377	JS922EF.....	66	K936.....	242	OMF243.....	80	OMS03.....	85
DHG-001.....	378	JS922HF.....	63	K937.....	243	OMF245.....	81	OMS04.....	85
DMM-001.....	378	JS922VF.....	64	K938.....	244	OMF251.....	82	OMS05.....	86
DSS.....	380	JS925VF.....	67	K940.....	244	OMM-X33.....	94	OMS06.....	86
FR2M.....	382	JT016.....	57	K941.....	244	OMM-X37.....	94	OMS07.....	86
GLAS/RTBRN.....	229	JT101A0.....	54	K950.....	241	OMM-X4.....	93	OMS08.....	87
IMBALLO143.....	385	JT101B.....	54	K955.....	245	OMM02.....	85	OMS09.....	87
JS032.....	59	JT101BIF.....	55	K958.....	241	OMM03.....	85	OMS10.....	87
JS1025VF.....	67	JT101BR.....	54	K965.....	241	OMM04.....	85	OMS11.....	87
JS1110VF.....	65	JT101D.....	55	OMA30.....	83, 93	OMM05.....	86	OMS12.....	88
JS1111DF.....	65	JT111C.....	53	OMA30000.....	83, 93	OMM06.....	86	OMS13.....	88
JS1111K.....	62	JT118A.....	56	OMA31.....	84	OMM07.....	86	OMS14.....	88
JS1120CF.....	68	JT118B.....	56	OMF-X4.....	82	OMM08.....	87	OMS15.....	89
JS1122AF.....	66	JT119B0.....	53	OMF001.....	80	OMM09.....	87	OMS16.....	89
JS1122BF.....	67	JT123X.....	56	OMF002.....	80	OMM1.....	85	OMS17.....	89
JS1122EF.....	66	JT127D.....	56	OMF106.....	73	OMM10.....	87	OMS18.....	89
JS1122HF.....	63	JT141HM.....	57	OMF113.....	73	OMM11.....	87	OMS19.....	90
JS1122VF.....	64	JT144D.....	53	OMF114.....	79	OMM12.....	88	OMS20.....	90
JS1125VF.....	67	JT218A.....	56	OMF118.....	79	OMM13.....	88	OMS21.....	90
JS1210VF.....	65	JT234X.....	55	OMF125.....	79	OMM14.....	88	OMS22.....	90
JS1222VF.....	64	JT244D.....	53	OMF126.....	74	OMM15.....	89	OMS23.....	91
JS1225VF.....	67	JT244DDC.....	53	OMF133.....	74	OMM16.....	89	OMS24.....	91
JS123XF.....	66	JT301CD.....	55	OMF136.....	83	OMM17.....	89	OMS27.....	91
JS1243HM.....	68	JT318VF.....	55	OMF157.....	78	OMM18.....	89	OMS29.....	92
JS1411DF.....	65	JT341HM.....	57	OMF160.....	77	OMM19.....	90	OMS30.....	92
JS1531L.....	62	JT344D.....	54	OMF165.....	81	OMM20.....	90	OMS35.....	88
JS1617K.....	62	JT718BF.....	56	OMF174.....	73	OMM21.....	90	OMS36.....	86
JS2243HM.....	68	JT744D.....	54	OMF183.....	76	OMM22.....	90	PCL.....	382
JS2345X.....	63	K.....	36	OMF184.....	76	OMM23.....	91	PGC.....	360
JS3456XF.....	63	K174.....	239	OMF201.....	82	OMM24.....	91	PGD-1.....	361
JS610VF.....	65	K906.....	240	OMF205.....	75	OMM25.....	92	PNL.....	233
JS611DF.....	64	K911.....	239	OMF221.....	77	OMM26.....	91	PPJ-002.....	358
JS617K.....	62	K911B.....	240	OMF222.....	78	OMM27.....	91	PTC-1.....	359
JS641HM.....	66	K912.....	239	OMF223.....	78	OMM28.....	92	RCS.....	372-374
JS644D.....	62	K914.....	240	OMF226.....	81	OMM29.....	92	TMP.....	376
JS711DF.....	64	K915.....	241	OMF228.....	77	OMM30.....	92	TMP-R12.....	376
JS725VFR.....	63	K918.....	242	OMF229.....	76	OMM35.....	88		
JS920CF.....	68	K922.....	242	OMF230.....	75	OMM36.....	86		
JS922AF.....	66	K927.....	243	OMF232.....	75	OMS01.....	85		

## Saw blade safety

- ALWAYS** thoroughly check all blades for damage and flaws before using. Do not use blades with missing or damaged teeth.
- ALWAYS** wear safety glasses and ear protection when using power tools.
- ALWAYS** thoroughly read the owners manual and manufacturer's instructions before working with tools.
- ALWAYS** use a fence and splitter when using the table saw. Do not make freehand cuts.
- ALWAYS** use pusher blocks or a pusher stick, especially when working with small or narrow pieces.
- ALWAYS** unplug your saw before cleaning or adjusting the tool, or before making blade changes.
- ALWAYS** keep your tools sharpened, clean and stored in a safe place to avoid breakage and accidents and to extend the life of your bits and blades.
- ALWAYS** feed the workpiece against the rotation of the blade on table saws.
- ALWAYS** be sure your workpiece is completely supported, before and after the cut.
- NEVER** remove guards from radial arm saws and miter saws.
- NEVER** remove the splitter or anti-kickback devices from table saws.
- NEVER** use dull or damaged blades.
- NEVER** use blades with missing or chipped teeth.
- NEVER** force the cut or overload the saw.
- NEVER** change blades with the saw is plugged in.
- NEVER** make adjustments to any saw while the blade is rotating.

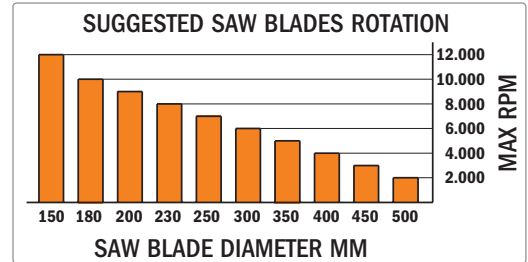

## Cutter head safety

- ALWAYS** thoroughly check all cutters for damage and flaws before using.
- ALWAYS** wear safety glasses and ear protection when using power tools.
- ALWAYS** thoroughly read the owners manual and manufacturer's instructions before working with tools.
- ALWAYS** use guards that were supplied with your shaper.
- ALWAYS** use a fence with your shaper. Do not make freehand cuts.
- ALWAYS** use pusher blocks, especially when working with small or narrow pieces.
- ALWAYS** unplug your shaper before cleaning or adjusting the tool, or before making cutter or knife changes.
- ALWAYS** be sure the spindle nut is tight before plugging in the shaper.
- ALWAYS** check that knives are properly and securely installed in the cutterhead when using interchangeable-knife systems.
- ALWAYS** keep your tools sharpened, clean and stored in a safe place to avoid breakage and accidents and to extend the life of your bits and blades.
- ALWAYS** feed the workpiece against the rotation of the knives.
- ALWAYS** be sure your workpiece is completely supported, before and after the cut.
- NEVER** remove guards or any other safety devices from your shaper.
- NEVER** use dull or damaged knives.
- NEVER** force the cut or overload the shaper.
- NEVER** change cutters or knives or make adjustments with the shaper plugged in.
- NEVER** make adjustments to the shaper while the cutter is rotating.

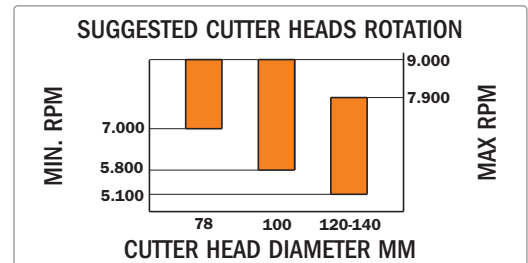

## Router bits safety

- ALWAYS** thoroughly check all tools for possible flaws before using.
- ALWAYS** wear safety glasses and ear protection.
- ALWAYS** thoroughly read the owners manual and manufacturer instructions before using.
- ALWAYS** check that at least 75% of the shank is securely inserted into the collet of the router.
- ALWAYS** use template guide collars when possible to absorb lateral bit deflection.
- ALWAYS** use a fence when working on the router table.
- ALWAYS** reduce the router speed when working with larger diameter bits.
- ALWAYS** keep your fence adjusted so there is some clearance between the bearing guide and the workpiece.
- ALWAYS** take care to remove large quantities of stock (cross section > 10mm) in more than one run.
- ALWAYS** keep your tools sharpened, clean and stored in a safe place to avoid breakage and accidents and to extend the life of your bits and blades.
- NEVER** use dull or defective tools, even suspiciously defective.
- NEVER** force the shank entirely into the collet (bottoming out). Leave about a 3,2mm (1/8") space from the bottom.
- NEVER** force the bit into your router or overload the router.

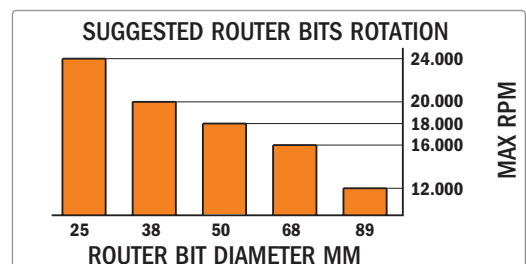
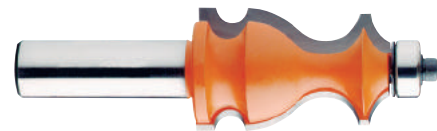

# Conversion Table



Inch Decimals	Inch Fractions (x)						Millimeters					
	1/64	1/32	1/16	1/8	1/4	1/2	mm	1" + (x)	2" + (x)	3" + (x)	4" + (x)	5" + (x)
0.015625	1/64						0.397	25.400	50.800	76.200	101.600	127.000
0.031250		1/32					0.794	25.797	51.197	76.597	101.997	127.397
0.046875	3/64						1.191	26.194	51.595	76.994	102.394	127.794
0.062500			1/16				1.588	26.591	51.991	77.391	102.791	128.191
0.078125	5/64						1.984	26.988	52.388	77.788	103.188	128.588
0.093750		3/32					2.381	27.384	52.784	78.184	103.584	128.984
0.109375	7/64						2.778	27.781	53.181	78.581	103.981	129.381
0.125000				1/8			3.175	28.178	53.578	78.978	104.378	129.778
0.140625	9/64						3.572	28.575	53.975	79.375	104.775	130.175
0.156250		5/32					3.969	28.972	54.372	79.772	105.172	130.572
0.171875	11/64						4.366	29.369	54.769	80.169	105.569	130.969
0.187500			3/16				4.762	29.766	55.166	80.568	105.966	131.366
0.203125	13/64						5.159	29.766	55.562	80.962	106.362	131.762
0.218750		7/32					5.556	30.162	55.959	81.359	106.759	132.159
0.234375	15/64						5.953	30.559	56.356	81.756	107.156	132.556
0.250000					1/4		6.350	31.353	56.753	82.153	107.553	132.953
0.265625	17/64						6.747	31.750	57.150	82.550	107.950	133.350
0.281250		9/32					7.144	32.147	57.547	82.947	108.347	133.747
0.296875	19/64						7.541	32.544	57.944	83.344	108.744	134.144
0.312500			5/16				7.938	32.941	58.341	83.741	109.141	134.541
0.328125	21/64						8.334	33.338	58.738	84.138	109.538	134.938
0.343750		11/32					8.731	33.734	59.134	84.534	109.934	135.334
0.359375	23/64						9.128	34.131	59.531	84.931	110.331	135.731
0.375000				3/8			9.526	34.528	59.928	85.328	110.728	136.128
0.390625	25/64						9.922	34.925	60.325	85.725	111.125	136.525
0.406250		13/32					10.319	35.322	60.722	86.122	111.522	136.922
0.421875	27/64						10.716	35.719	61.119	86.519	111.919	137.319
0.437500			7/16				11.112	36.116	61.516	86.916	112.316	137.716
0.453125	29/64						11.509	36.512	61.912	87.312	112.712	138.112
0.468750		15/32					11.906	36.909	62.309	87.709	113.109	138.509
0.484375	31/64						12.303	37.306	62.706	88.106	113.506	138.906
0.500000						1/2	12.700	37.703	63.103	88.503	113.903	139.303
0.515625	33/64						13.097	38.100	63.500	88.900	114.300	139.700
0.531250		17/32					13.494	38.497	63.897	89.297	114.697	140.097
0.546875	35/64						13.891	38.894	64.294	89.694	115.094	140.494
0.562500			9/16				14.288	39.291	64.691	90.091	115.491	140.891
0.578125	37/64						14.684	39.688	65.088	90.488	115.888	141.288
0.593750		19/32					15.081	40.084	65.484	90.884	116.284	141.684
0.609375	39/64						15.478	40.481	65.881	91.281	116.681	142.081
0.625000				5/8			15.875	40.878	66.278	91.678	117.078	142.478
0.640625	41/64						16.272	41.275	66.675	92.075	117.475	142.875
0.656250		21/32					16.669	41.672	67.072	92.472	117.872	143.272
0.671875	43/64						17.066	42.069	67.469	92.869	118.269	143.669
0.687500			11/16				17.462	42.466	67.866	93.266	118.666	144.066
0.703125	45/64						17.859	42.862	68.262	93.662	119.062	144.462
0.718750		23/32					18.256	43.259	68.659	94.059	119.459	144.859
0.734375	47/64						18.653	43.656	69.056	94.456	119.856	145.256
0.750000					3/4		19.050	44.053	69.453	94.855	120.253	145.653
0.765625	49/64						19.447	44.450	69.850	95.250	120.650	146.050
0.781250		25/32					19.844	44.847	70.247	95.647	121.047	146.447
0.796875	51/64						20.241	45.244	70.644	96.044	121.444	146.844
0.812500			13/16				20.638	45.641	71.041	96.441	121.841	147.241
0.828125	53/64						21.034	46.038	71.438	96.838	122.238	147.638
0.843750		27/32					21.431	46.434	71.834	97.234	122.634	148.034
0.859375	55/64						21.828	46.831	72.231	97.631	123.031	148.431
0.875000				7/8			22.225	47.228	72.628	98.028	123.428	148.828
0.890625	57/64						22.622	47.625	73.025	98.425	123.825	149.225
0.906250		29/32					23.019	48.022	73.422	98.822	124.222	149.622
0.921875	59/64						23.416	48.419	73.819	99.219	124.619	150.019
0.937500			15/16				23.812	48.816	74.216	99.616	125.016	150.416
0.953125	61/64						24.209	49.212	74.612	100.012	125.412	150.812
0.968750		31/32					24.606	49.609	75.009	101.409	126.809	152.209
0.984375	63/64						25.003	50.000	75.406	101.806	127.206	152.606
							25.400	50.403	75.803	102.203	127.603	153.003



# Explanation of Symbols

  Tungsten Carbide Tipped	 Carbide Grit	 Solid Tungsten Carbide	 Insert Carbide
 Alloyed Tools Steel	 High Speed Steel	 High Performance Steel	 High Carbon Steel
 High-Alloyed Tool Steel	 Heavy-Duty Steel 44 HRC	 Bimetal	 TiN Coated Bimetal with 8% Cobalt Teeth
 Cermet Carbide	 Polycrystalline Diamond	 Polycrystalline Diamond	 Diamond Grit
 Tool with Bearing	 One Cutting Edge	 Two Cutting Edges	 Three Cutting Edges
 Four Cutting Edges	 One + One Cutting Edges	 Two + One Cutting Edges	 Two + Two Cutting Edges
 Three + Three Cutting Edges	 Four + Four Cutting Edges	 Three Cutting Edges with Chipbreaker	 One Spur
 Two Spur	 Four Spur	 Right-hand Rotation	 Left-hand Rotation
 Right-hand & Left-hand Rotation	 Antikick-back	 Radial Relief	 Tool with Plunging Capacity
 Axial Angle	 Mechanical Feed	 Manual Feed	 Flush Trimming
 Grooving, Sizing	 Rebating, Profiling, Beveling	 Slotting	 Spiral Boring
 Avoid Axial Plunging	 Not for Hand Held use for Router Table only	 Saw Blade with Dampening Slots with Fill	 Saw Blade with Dampening Slots without Fill
 Plastic Carry Case for Saw Blades	 Clamshell Carry Case for Saw Blades	 Cardboard Box for Saw Blades	 Plastic Box for Cutter Head
 Plastic Box for Router Bits	 ORANGE CHROME®	 Non-Stick Orange Shield Coating®	 CMT CONTRACTOR TOOLS®
 INDUSTRIAL ITK ORANGE®	 Shear Angle Grind	 XTREME High Performance Tool	 EXTRA HARD DLCS CHROME COATING
 Wear Five Finger Gloves	 Wear Safety Glasses	 Wear Ear Protection	 Wear Dust Mask
 Wear Safety Shoes	 Wear Safety Helmet	HV10 Hardness Vickers 10kg (HV10)	N/mm <sup>2</sup> Transverse Rupture Strength (expressed in N/mm <sup>2</sup> )
 Warning			

# Conditions of trading

## PREMISE

**C.M.T.** products are the result of technological innovation achieved through continuous research applied on a vast scale. Drawings, technical data, photos of the products and packaging are supplied for the sole purpose of informing the customer and are not binding in any manner. **C.M.T.** may undertake, when necessary, modifications and improvements without applying these innovations to the parts already supplied. The operational tolerances conform to technical standards that are acceptable for this range of tools.

## ACCEPTANCE OF THE CONTRACT

All orders for our products are meant to be accepted at the price and sale conditions that are legally in force at the date of delivery. Every order will be treated and supplied according to the following general sale conditions. By placing an order or accepting an offer, the customer accepts, without any reservations, all conditions expressly mentioned hereafter.

Any other derogation will only be accepted upon written consent by **C.M.T.** All other cases not contained within these conditions will fall under the Italian Civil Code.

Offers and order confirmations will be processed according to stock availability. Any order, even those taken by our representative agents, will be subject to our acceptance, which could also be a partial one.

We will notify the acceptance of any order by an order confirmation in which we will indicate all details pertaining to the items purchased, their price and expected delivery date. Therefore, we will not be able to accept any modification after three working days from the date of receipt.

## MINIMUM AMOUNT ACCEPTABLE

**C.M.T.** will only be able to accept and process orders for a minimum net amount of € 100,00.

In case of acceptance of the order, we will add € 15,00 for shipping and handling.

## PRICES

The prices stated in **C.M.T.**'s quotation and price lists are gross and are intended to be "ex-works".

Prices and VAT will be those in force at the date of shipping. To the best of our knowledge, the prices indicated in our catalogues, price lists and order confirmations are correct. However, **C.M.T.** cannot be held legally liable for reserving the right to change prices without notification in line with the manufacturer's cost increases.

## DELIVERY

Delivery dates in the order confirmation are given as an indication of the estimated delivery time. They have to be considered as reliable only in case of normal operating conditions, and there shall be no liability on the part of the Seller for any failure to deliver due to causes beyond the Seller's control. **C.M.T.** will also not be able to accept any cancellation of existing orders which were not delivered in time due to external impediments.

Standard products will be shipped within five working days from receipt of the order.

## SHIPPING AND HANDLING

The packing of our products will be charged on the final invoice, while shipping is "ex-works" from our factory at Chiusa di Ginestreto (Pesaro).

All products supplied by **C.M.T.** travel at the customer's own risk.

**C.M.T.** retains the right to charge freight costs on the invoice in case of value under the minimum amount acceptable of €100,00.

**C.M.T.** will not be held responsible for any damage, theft or tampering that might occur during transport, and for which the forwarder will be legally liable according to article 1693 of the Civil Code. The customer, for his part, will have to check the goods at the moment of receipt and, in case any anomaly or damage is found, he will have to apply for a refund to be addressed to the forwarder.

## PAYMENT

Cash payments can only be accepted for purchases done directly at the **C.M.T.** factory located in Chiusa di Ginestreto (Pesaro) in accordance with article 1182, sub-section 3 of the Civil Code, or upon delivery of the goods provided there is a written agreement between the parties.

Deferred methods of payment will have to be previously agreed with the Seller. In this case, if one or more instalments are not paid, the agreement will automatically expire according to article 1186 of the Civil Code.

A delay in payment, even partial, will automatically incur interest in the amount of an extra 5% to be charged to the customer's account.

In case of non payment, **C.M.T.** reserves the right to suspend any further supply of its products.

## WARRANTY

All professional tools by **C.M.T.** are manufactured according to high standards of technology and are therefore warranted against any possible defect. This warranty does not cover damage or tampering which can be ascribed to inappropriate use. It is also not applicable for tools that have been re-sharpened.

This warranty does not cover the possible injuries resulting from inappropriate use of defective tools.

**C.M.T.** will repair or replace any goods which the buyer shall prove to have been defective in material or workmanship upon analysis by its technical department. Any complaint must be communicated within fifteen days from receipt of the goods together with a written form in which the customer provides a detailed description of the defect. Any return of tools will only be accepted upon authorisation by **C.M.T.** and the freight will be at the customer's own expense.

## OWNERSHIP RIGHTS

All rights are reserved in accordance with Italian law and with international agreements, and the whole or any part of this catalogue may not be reproduced in any way or form.

## PLACE OF JURISDICTION

For any legal matter the place of jurisdiction is Pesaro.

All contracts, even those made with foreign Buyers or for goods to be sent abroad, are regulated by Italian legislation.

---

© CMT, the CMT logo and the orange color applied to tool surfaces are trademarks of C.M.T. UTENSILI S.P.A.

Any other brand names mentioned in CMT product catalogues and on the CMT website are the property of their respective owners.

© **C.M.T. UTENSILI S.P.A.**

This document has been sent for your personal use only.

All usage and reproduction is forbidden without written permission from C.M.T. UTENSILI S.P.A.

**[www.cmtorangetools.com](http://www.cmtorangetools.com)**

